

**Appendix D:**  
**Acoustic Assessment Report**

**Niagara Region Wind Farm  
Acoustic Assessment Report – REA  
Amendment**

File No. 160961052  
–(160950269)



---

**Stantec**

Prepared for:  
**FWRN LP**  
4672 Bartlett Road South  
Beamsville, ON L0R 1B1

Prepared by:  
**Stantec Consulting Ltd.**  
300-675 Cochrane Drive, West Tower  
Markham, ON L3R 0B8

October 02, 2015

## Version Control

*Noise Assessment Report – Niagara Region Wind Farm (230 MW), Ontario*

VERSION	DATE	DESCRIPTION	PREPARED BY
1	November 2012	Noise Assessment report of NRWC 230 MW Wind energy project with substation transformers – prepared for Municipal submission	Stantec
2	December 2012	Updated Noise Assessment report of NRWC 230 MW Wind energy project with substation transformers – prepared for Public Release including comments from municipality	Stantec
3	April 2013	Prepared for Final submission to the MOE	Stantec
4	July 2013	Prepared for Final submission to the MOE – Appendix F with additional information added	Stantec
5	September 2013	Prepared for Final submission to the MOE with manufacturer data for 10 m/s wind speed added – Appendix F with additional information added	Stantec
6	May 2014	Prepared for Final submission to the MOE with receptor ID change as discussed with MOE – Appendix G with additional rational for Receptors included. Report also presents single option for wind turbine selection	Stantec
7	September 2014	Prepared for Final submission to the MOE with PORs O_1002, O_2922, O-856, O-986 moved to center of buildings and O_3139 and O-3142 designated as V_3139, V_3142 from all previous reports.	Stantec
8	October 2015	<p>Updated September 2014 (Included in the Final REA) report to include the following proposed changes:</p> <ol style="list-style-type: none"> <li>1. The turbine model and tower height at 11 select locations resulting in all project turbines at 124 m hub height;</li> <li>2. Update to the transformer barrier location based on detail engineering completed to date; and</li> <li>3. Status change for POR 2550 from participating to non-participating (i.e. from P_2550 to O_2550)</li> </ol> <p>This report also serves as the supporting document for the proposed amendment application to reflect the above changes.</p>	Stantec

## Table of Contents

---

<b>EXECUTIVE SUMMARY .....</b>	<b>IV</b>
<b>1.0 INTRODUCTION .....</b>	<b>1.1</b>
1.1 BACKGROUND .....	1.1
<hr/>	
<b>2.0 PROJECT DESCRIPTION .....</b>	<b>2.1</b>
2.1 PROJECT LOCATION.....	2.1
2.2 PROJECT DETAILS .....	2.1
2.3 PROJECT WIND TURBINE GENERATORS.....	2.1
2.4 OPERATION SCENARIO .....	2.2
<hr/>	
<b>3.0 NOISE SOURCE SUMMARY .....</b>	<b>3.1</b>
3.1 NOISE SOURCES .....	3.1
3.2 SOUND CHARACTER ADJUSTMENTS .....	3.8
3.3 CUMULATIVE EFFECTS .....	3.8
<hr/>	
<b>4.0 POINTS OF RECEPTION.....</b>	<b>4.1</b>
4.1 DEFINITION OF A POINT OF RECEPTION .....	4.1
4.2 EXISTING POINTS OF RECEPTION .....	4.2
<hr/>	
<b>5.0 NOISE ASSESSMENT CRITERIA .....</b>	<b>5.1</b>
5.1 MOE GUIDELINE LIMITS.....	5.1
<hr/>	
<b>6.0 IMPACT ASSESSMENT .....</b>	<b>6.1</b>
6.1 METHODOLOGY.....	6.1
6.2 RESULTS AND RECOMMENDATIONS .....	6.2
6.2.1 Project and Cumulative Effects.....	6.2
<hr/>	
<b>7.0 CONCLUSIONS AND CLOSURE .....</b>	<b>7.1</b>



**LIST OF TABLES**

Table 2.1	Basic Wind Turbine Specifications.....	2.2
Table 3.1	Wind Turbine Sound Emission Summary .....	3.3
Table 3.2	Highest Wind Turbine Sound Emission Corresponding to 95% or above Rated Electrical Output Power .....	3.4
Table 3.3	Substation Transformer Sound Emission Data .....	3.4
Table 3.4	Noise Source Summary Table .....	3.5
Table 3.5	Wind Turbine Locations .....	3.5
Table 3.6	Substation Transformer Locations .....	3.8
Table 3.7	Adjacent Wind Farms within 5 km of the Project .....	3.8
Table 3.8	Assessed Noise Sources Associated with Adjacent or Proposed Wind Farms within 5 km.....	3.9
Table 4.1	Nearby Points of Reception .....	4.3
Table 5.1	Wind Turbine Sound Pressure Limits for Class 3 Area.....	5.1
Table 6.1	Atmospheric Absorption Coefficient (based on 10 degree Celsius and 70% Relative Humidity).....	6.1
Table 6.2	Noise Impact Assessment Summary Table*.....	6.3
Table 6.3	Noise Impact Assessment Summary Table for Mutual PORs for NRWC and Mohawk Point Wind Farm WTGs.....	6.5

**LIST OF FIGURES**

Figure 1.1	Study Area Overview .....	1.3
Figure 2.1	Locations of Project Infrastructure within Study Area .....	2.3
Figure 6.1	Predicted Equivalent Sound Level Contours (Cumulative Effects - Day/Nighttime Hours).....	6.4

**LIST OF APPENDICES**

<b>APPENDIX A</b>	<b>ZONING MAPS .....</b>	<b>A.1</b>
<b>APPENDIX B</b>	<b>PROJECT LAYOUT PLAN .....</b>	<b>B.1</b>
<b>APPENDIX C</b>	<b>RESULTS FOR ALL POINTS OF RECEPTION (PORS) .....</b>	<b>C.1</b>
<b>APPENDIX D</b>	<b>EQUIPMENT SPECIFICATION .....</b>	<b>D.1</b>
<b>APPENDIX E</b>	<b>SAMPLE CALCULATIONS AND CADNA/A INPUTS/OUTPUTS (IN THE ATTACHED CD) .....</b>	<b>E.1</b>
<b>APPENDIX F</b>	<b>ADDITIONAL INFORMATION .....</b>	<b>F.1</b>
	Manufacturers sound emission and adjusted sound emission .....	F.2
	Manufacturer’s catalog data.....	F.3
	Adjacent Wind Farm .....	F.4
	Sample Calculation in Octave Band (V_1541, V1759, O_1624) .....	F.5
	Transformer Barrier Coordinates .....	F.6
<b>APPENDIX G</b>	<b>RESPONSE TO MINISTRY OF THE ENVIRONMENT TECHNICAL REVIEW COMMENTS .....</b>	<b>G.1</b>

## Executive Summary

---

Stantec Consulting Ltd. has been retained by FWRN LP to update the Acoustic Assessment Report (updated AAR/2015 AAR) for the approved 230 MW wind energy generation facility (Approval number 4353-9HMP2R dated November 6, 2014) known as the Niagara Region Wind Farm (the Project).

The Project is located within the Townships of West Lincoln and Wainfleet and the Town of Lincoln within the Niagara Region and within Haldimand County in Southern Ontario, in response to the Government of Ontario's initiative to promote the development of renewable energy in the province. This updated AAR has been prepared in support of an application for an amendment to the above noted Renewable Energy Approval (REA) provided to the Project in accordance with Ontario Regulation 359/09.

This updated AAR is provided in support of the following changes:

- The turbine model at 11 locations will be changed to a customized E101 2.9 MW turbine with a hub height of 124 meters and a sound power level (SPL) of 102.9 dBA. This customized turbine model replaces 11 approved turbines, as follows:
  - Three (3) E82 2.3 MW with hub height 135 meters;
  - Six (6) E101 3MW with hub height 135 meters; and
  - Two (2) E101 3MW with hub height 124 meters;
- Update to the transformer barrier based on detailed engineering completed to date; and
- Status change for POR 2550 from participating to non-participating (i.e. from P\_2550 to O\_2550).

The Project will include the construction and operation of 77 ENERCON wind turbine generators (80 potential locations have been identified and assessed) each with a rated capacity ranging from approximately 2.9 MW to 3.0 MW with a maximum installed nameplate capacity of 230 MW. The selected wind turbine models for the Project are 69 x ENERCON E101 3.0 MW and 11 x customized ENERCON E101 2.9 MW G2/G3 models, all with a hub height of 124 m, to achieve the contract capacity of 230 MW (maximum capacity not to exceed 230 MW). The location of the turbines have not changed from the locations identified in the REA.

The proposed changes represents an improvement to the Project (turbine models with reduced sound power level; transformer barrier located closer to sources, and POR 2550 sound level reduces to levels below 40 dBA). Therefore, the acoustical effect of the proposed changes are considered minor.

This updated AAR was prepared in accordance with the requirements of the Ontario Ministry of the Environment guideline “*Noise Guidelines for Wind Farms*” (PIBs 4709e, October 2008).

The Project layout, the main noise sources and sound power levels were determined based on the information provided by planners and equipment manufacturers. The source sound power levels were used as inputs to a prediction model based on the ISO 9613 standard. The acoustic assessment considers operation under predictable worst-case operating conditions to quantify the noise emissions from the Project. The resulting sound levels at the sensitive points of reception were assessed for compliance against assessment criteria that were established following the guidelines provided in MOE publications *NPC-232* and PIBs 4709e.

The assessment considers the effects of two substation transformers, and 80 potential wind turbine generators (WTG) of which only 77 turbines would ultimately be constructed. Furthermore, this assessment presents a wind turbine layout consisting of 80 WTGs with 124 metre hub height. The assessment indicated that the noise contribution from the proposed project during the predictable worst case operation would meet the MOE noise criteria with the requirement for additional noise control for the substation transformers.

Additional information on turbine sound power data and rationale for location and classification of some of the receptors previously included in the approved Noise Assessment Report (September 2014), which was included based on discussions with the MOE during the MOE technical review process and based on comments received through the 60-day EBR posting for this Project, remains in this report.

## 1.0 Introduction

---

Stantec Consulting Ltd. (Stantec) was retained by FWRN LP (FWRN) to update the acoustic assessment report (AAR) completed for REA Approval (Approval number 4353-9HMP2R dated November 6, 2014) for its proposed Niagara Region Wind Farm (the Project) with a rated generation capacity of 230 Megawatts (MW). FWRN (formally Niagara Region Wind Corporation) has approval to develop, construct, and operate the Project within the Townships of West Lincoln and Wainfleet and the Town of Lincoln within the Niagara Region and Haldimand County in Southern Ontario, in response to the Government of Ontario's initiative to promote the development of renewable energy in the province. This acoustic assessment considers the effects of the two proposed transformer substations and 80 potential wind turbine generators (WTG) of which only 77 turbines would ultimately be constructed. This report has been prepared as a supporting document for FWRN's application for amendment of the Renewable Energy Approval (REA) (Approval number 4353-9HMP2R dated November 6, 2014).

The Project study area covers approximately 27,727 ha. An area map showing the study area and sensitive Points of Reception (PORs) is provided in Figure 1.1. A zoning map of the area surrounding the Project is provided in **Appendix A**. The area's acoustical environment is best described as Class 3 (Rural) in accordance with the MOE publications NPC-232 and "Noise Guidelines for Wind Farms" (PIBs 4709e, October 2008). There are no notable changes in the above descriptions (i.e. study area extent, zoning, acoustical environment etc.) since approval in November 2014.

This updated acoustic assessment continues to consider the sound levels at 2670 receptors included in the REA application, which are located within approximately 1.5 km of the Project wind turbines. The receptors include all non-participating existing and vacant lot receptors as well as participating receptors as discussed further in Section 4.0.

### 1.1 BACKGROUND

The Ontario Regulation 359/09 (O.Reg. 359/09) made under *Environmental Protection Act*, Renewable Energy Approvals (REA) under Part V.0.1 of the Act, provides current approval requirements for renewable energy projects. The noise assessment of wind farms was previously assessed using O.Reg. 116/01 and are now assessed under O.Reg. 359/09.

According to the project classification guidelines provided under Section 2(6) of O.Reg. 359/09, the Project is classified as a Class 4 wind facility, where: no part of a wind turbine will be located in direct contact with surface water other than in a wetland; the facility has a name plate capacity greater than 50 kW; and, the greatest sound power level is greater than or equal to 102 dBA. Section 54 of O.Reg. 359/09 requires that noise studies be conducted for Class 4 wind facilities in accordance with PIBs 4709e and subsequent amendments. An assessment meeting the above noted requirements and approval was obtained (Approval number 4353-9HMP2R dated November 6, 2014). This updated AAR continues to meet the above noted requirements.



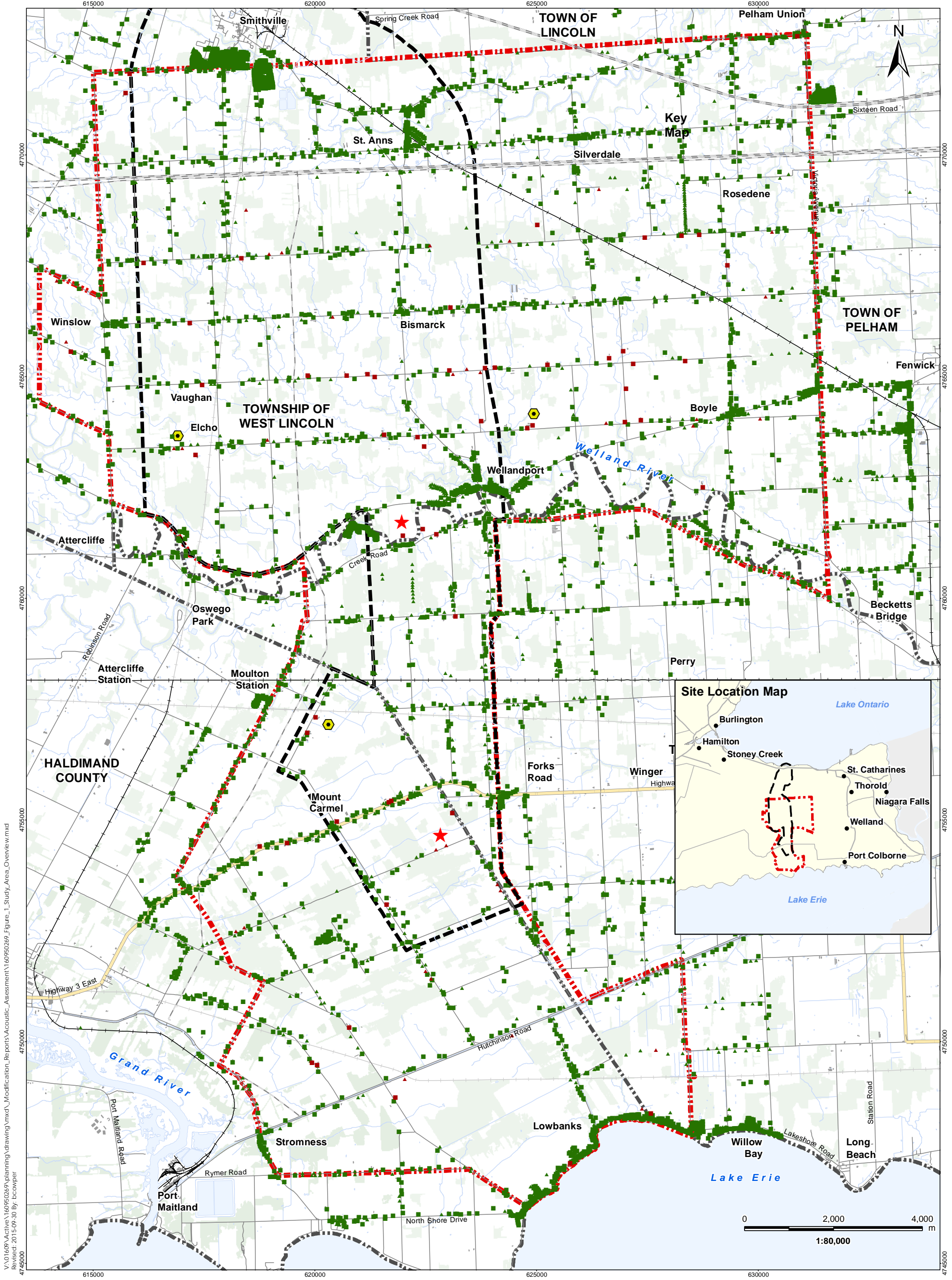

V:\01609\Actives\160950269\planning\drawing\mxd\Modification\_Reports\Acoustic\_Assessment\160950269\_Figure\_1\_Study\_Area\_Overview.mxd  
 Revised: 2015-09-30 By: bcompier



Legend	
	Project Study Area
	Interconnector Study Area
	Transformer Substation
	Tap-in Location
	Existing Met Tower
	Road
	Expressway / Highway
	Active Railway
	Abandoned Railway
	Existing Structures
	Existing Transmission Line
	Watercourse
	Waterbody
	Wooded Area
	Municipality Lower Tier
	Participating Noise Receptors
	Occupied
	Vacant
	Non-participating Noise Receptors
	Occupied
	Vacant

Client/Project  
 FWRN LP  
 Niagara Region Wind Farm  
 Acoustic Assessment Report

Figure No.  
 1.1  
 Title  
 Study Area Overview

Notes  
 1. Coordinate System: NAD 1983 UTM Zone 17N  
 2. Base features produced under license with the Ontario Ministry of Natural Resources © Queen's Printer for Ontario, 2011.

## 2.0 Project Description

---

### 2.1 PROJECT LOCATION

REA approval was granted by the MOECC to develop, construct, and operate the 230 MW Niagara Region Wind Farm (the Project) within the Townships of West Lincoln and Wainfleet and the Town of Lincoln within the Niagara Region and Haldimand County in Southern Ontario. The Project Study Area is centred in the Townships of West Lincoln and Wainfleet as shown in Figure 1.1.

The predominant land-use in the Project Study Area is generally agricultural. The proposed wind turbine locations and PORs considered as part of the REA approval and this amendment are provided in **Appendix B** and Figure 2.1

### 2.2 PROJECT DETAILS

The basic components of the Project include 77 wind turbine generators (80 potential locations identified) each with a rated generation capacity ranging from approximately 2.9 MW to 3.0 MW, for a maximum installed nameplate capacity of 230 MW. An overhead and/or underground collection system connects each turbine to one of two transformer substations via a series of 34.5 kilovolt (kV) collection lines. Turbines are grouped into nine (9) collector circuits that bring power (and data via fibre optic lines) to one of the transformer substations. Voltage is stepped up from 34.5kV to 115kV at each transformer substation by means of a 90 MVA base-rated transformer at the north sub-station and a 69 MVA transformer at the south sub-station, each with two stages of cooling. A 115kV transmission line transports power from each of the two transformer substations north to the grid tap-in location, where the Project is connected to the Hydro One Networks Inc. (HONI) owned transmission line, south of the Queen Elizabeth Way (QEW) in the Town of Lincoln. Power generated from this Project will be conveyed along the existing HONI transmission line to the Beach Transformer Station in Hamilton.

### 2.3 PROJECT WIND TURBINE GENERATORS

The Project will include 77 ENERCON wind turbine generators (80 potential locations identified) each with a rated capacity ranging from approximately 2.9 MW to 3.0 MW with a maximum installed nameplate capacity of 230 MW.

The selected wind turbine models for the Project are the ENERCON E101 3.0 MW and customized ENERCON E101 2.9 MW G2/G3 models achieve the contract capacity of 230 MW (maximum capacity not to exceed 230 MW). Specifications of the E101 3.0 MW and customized ENERCON E101 2.9 MW G2/G3 model turbines are summarized below in Table 2.1.

**Table 2.1 Basic Wind Turbine Specifications**

Manufacturer	ENERCON <sup>2</sup>	ENERCON <sup>2</sup>
Model	E101	E101 2.9 MW G2/G3
Name plate capacity (MW)	3.0 MW	2.9 MW
Hub height above grade	124 m	124 m
Blade length	48.6m	48.6 m
Rotor diameter	101 m	101 m
Blade sweep area	8,012 m <sup>2</sup>	8,012 m <sup>2</sup>
Rotational Speed	Variable, 4 – 14.5 rpm	4 – 14.5 rpm
Noise Emission Power Level <sup>1</sup>	104.8 dBA (referenced to 10 <sup>-12</sup> Watts)	102.9 dBA (referenced to 10 <sup>-12</sup> Watts)
Output Electrical Frequency	50 Hz or 60 Hz	50 Hz or 60 Hz

<sup>1</sup> test data from an independent consultant for the Enercon customized E101 2.9 MW G2/G3 and E101 3.0 MW models are provided in Appendix D for operating windspeed.

<sup>2</sup> Additional information on sound power data from Enercon dated April 15, 2014 for E101 3.0 MW and dated May 05, 2015 for customized E101 2.9 MW G2/G3 included in Appendix G

## 2.4 OPERATION SCENARIO

The wind farm will operate throughout the year during the daytime and night-time hours when favorable wind conditions exist. The facility is expected to operate 7 days a week throughout the year. A project layout diagram is included in **Appendix B**. The noise emissions for the layout shown in Figure 2.1 were assessed for hub heights of 124 m as follows:

Among the 80 WTGs, 11 will be ENERCON E101 2.9 MW G2/G3 turbine model and 69 will be ENERCON E101 3.0 MW model. All turbines will have a hub height of 124 m.

The REA, including the previous submission of the NAR (Stantec, September 2014), included turbines proposed at different hub heights (i.e. 124 m and 135 m). However, the amended project design proposes that all WTGs will be at a tower height of 124 metres. As such, the above noted operation scenario has have been assessed (as listed in Table 3.5).



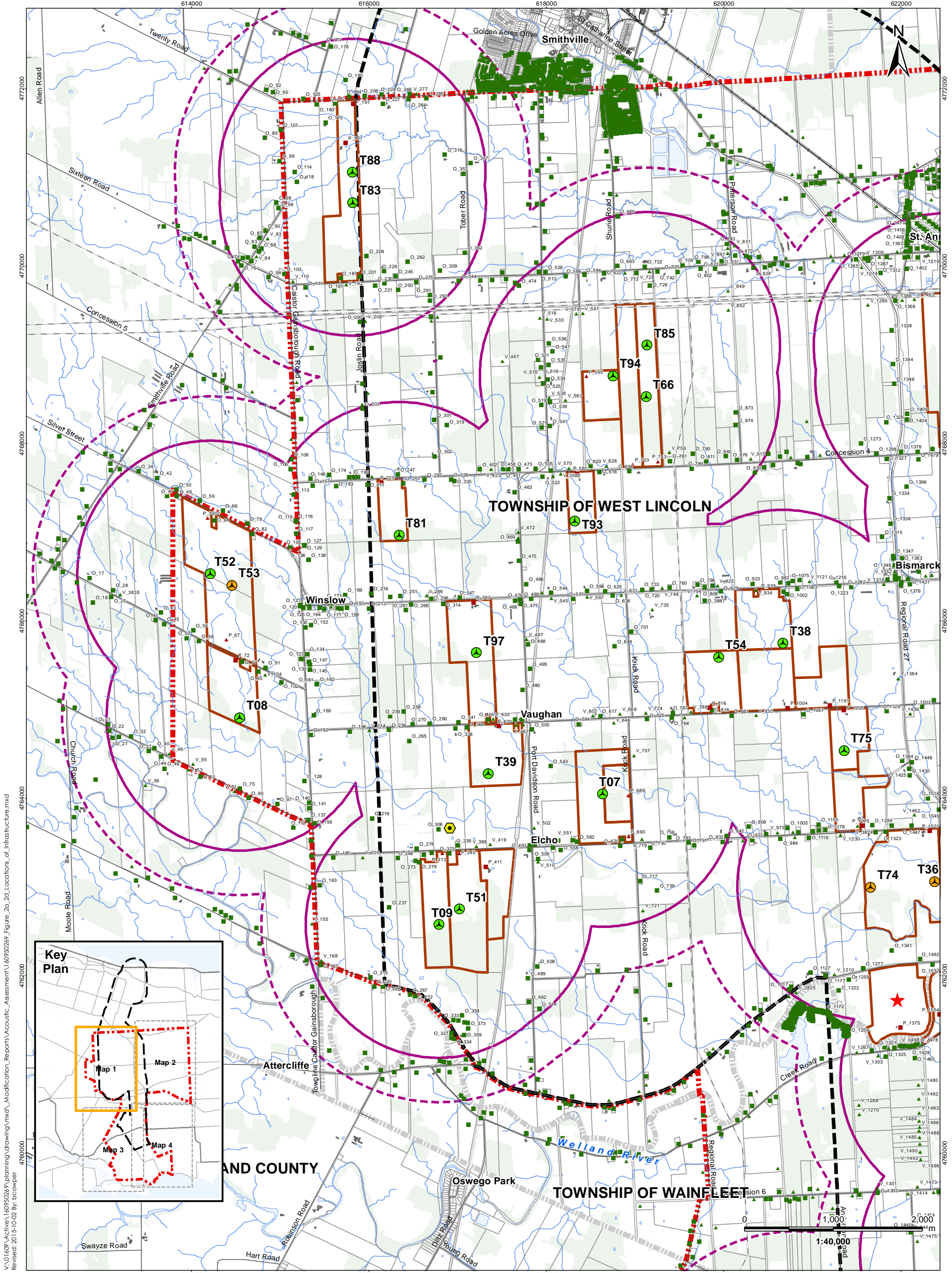

V:\01609\Projects\160950269\planning\drawing\mxd\_Modification\_Reports\Acoustic\_Assessment\160950269\_Figure\_2a\_2d\_Locations\_of\_Infrastructure.mxd  
 Reviset: 2015-10-02 By: bcowper



**Legend**

- |  |                            |  |
|--|----------------------------|--|
| Project Study Area                               | Road                       | Participating Noise Receptors - Occupied     |
| Interconnector Study Area                        | Expressway / Highway       | Participating Noise Receptors - Vacant       |
| Proposed Turbine Location - E101 3.0 MW          | Active Railway             | Non-participating Noise Receptors - Occupied |
| Proposed Turbine Location - E101 2.9 MW G2/G3    | Abandoned Railway          | Non-participating Noise Receptors - Vacant   |
| Transformer Substation                           | Existing Transmission Line |  |
| Tap-in Location                                  | Existing Structures        |  |
| Existing Met Tower                               | Watercourse                |  |
| 1.5 km Radius from Proposed Turbine Centre Point | Waterbody                  |  |
| 2km Radius from Proposed Turbine Centre Point    | Wooded Area                |  |
|  | Municipal Boundary         |  |

Client/Project  
 FWRN LP  
 Niagara Region Wind Farm  
 Acoustic Assessment Report

**Notes**

- Coordinate System: NAD 1983 UTM Zone 17N
- Base features produced under license with the Ontario Ministry of Natural Resources © Queen's Printer for Ontario, 2012.
- Scenario 1 - T36, T46, T53 are E82 model at hub height 135 metre; T18, T45, T47, T55, T60 and T74 are E101 model at hub height 135 metre and the rest are E101 model at hub height 124 metre. Scenario 2 - T36, T46, T53 are E82 model at hub height 135 metre; and the rest are E101 model at hub height 135 metre.

Figure No.  
**2.1a**

Title  
**Locations of Project Infrastructure within Study Area: Map 1 of 4**

October 2015  
 160950269



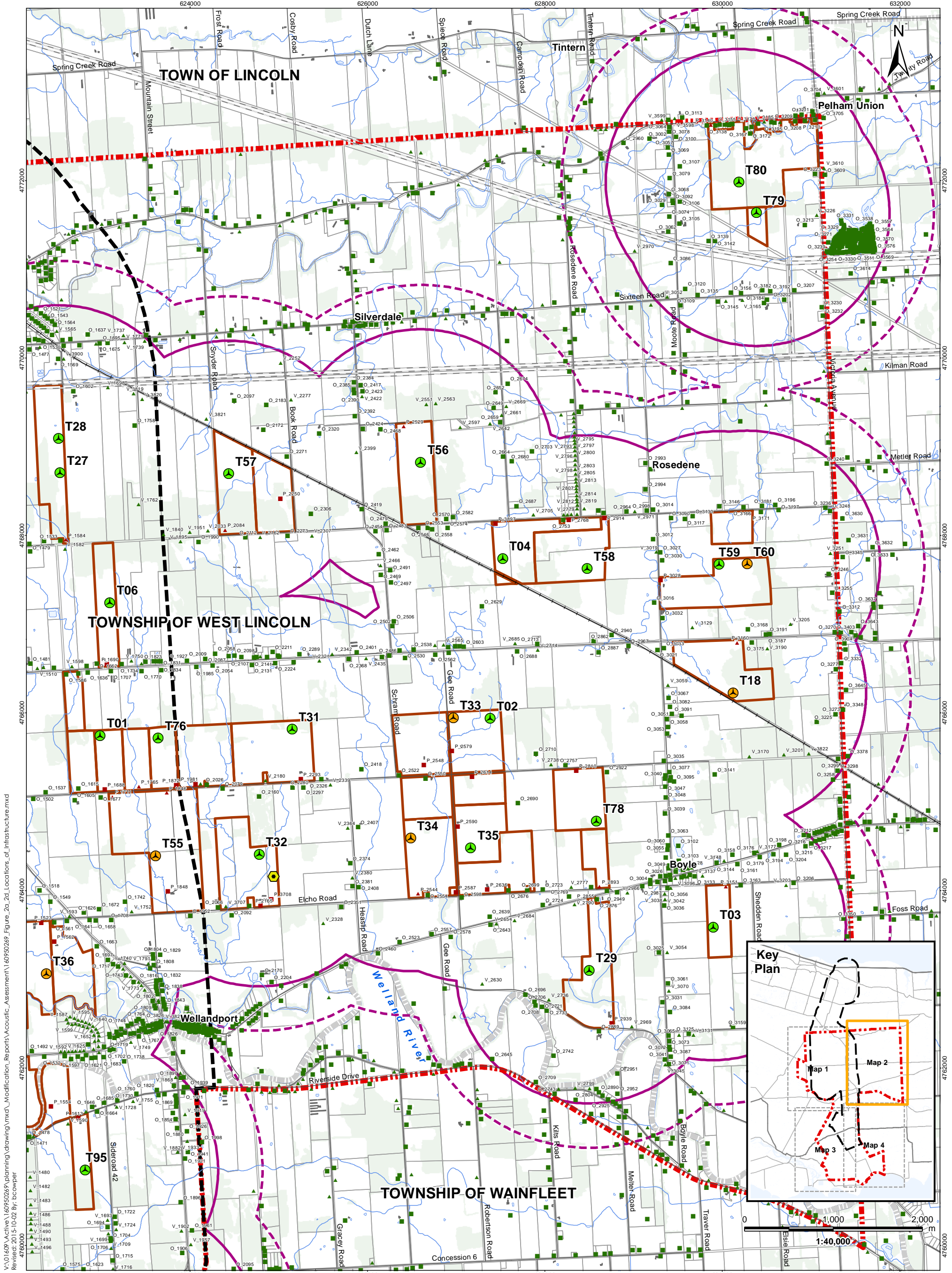

V:\01609\Projects\160950269\planning\drawing\mxd\Modification\_Reports\Acoustic\_Assessment\160950269\_Figure\_2a\_2d\_Locations\_of\_Infrastructure.mxd  
 Revised: 2015-10-02 By: bcowper



**Legend**

- |  |                            |                                   |
|--|----------------------------|-----------------------------------|
| Project Study Area                               | Road                       | Participating Noise Receptors     |
| Interconnector Study Area                        | Expressway / Highway       | Occupied                          |
| Proposed Turbine Location - E101 3.0 MW          | Active Railway             | Vacant                            |
| Proposed Turbine Location - E101 2.9 MW G2/G3    | Abandoned Railway          | Non-participating Noise Receptors |
| Transformer Substation                           | Existing Transmission Line | Occupied                          |
| Tap-in Location                                  | Existing Structures        | Vacant                            |
| Existing Met Tower                               | Watercourse                |                                   |
| 1.5 km Radius from Proposed Turbine Centre Point | Waterbody                  |                                   |
| 2km Radius from Proposed Turbine Centre Point    | Wooded Area                |                                   |
|  | Municipal Boundary         |                                   |

Client/Project  
 FWRN LP  
 Niagara Region Wind Farm  
 Acoustic Assessment Report

October 2015  
 160950269

- Notes**
- Coordinate System: NAD 1983 UTM Zone 17N
  - Base features produced under license with the Ontario Ministry of Natural Resources © Queen's Printer for Ontario, 2012.
  - Scenario 1 - T36, T46, T53 are E82 model at hub height 135 metre; T18, T45, T47, T55, T60 and T74 are E101 model at hub height 135 metre and the rest are E101 model at hub height 124 metre. Scenario 2 - T36, T46, T53 are E82 model at hub height 135 metre; and the rest are E101 model at hub height 135 metre.

Figure No.  
 2.1b  
 Title  
 Locations of Project Infrastructure within Study Area: Map 2 of 4



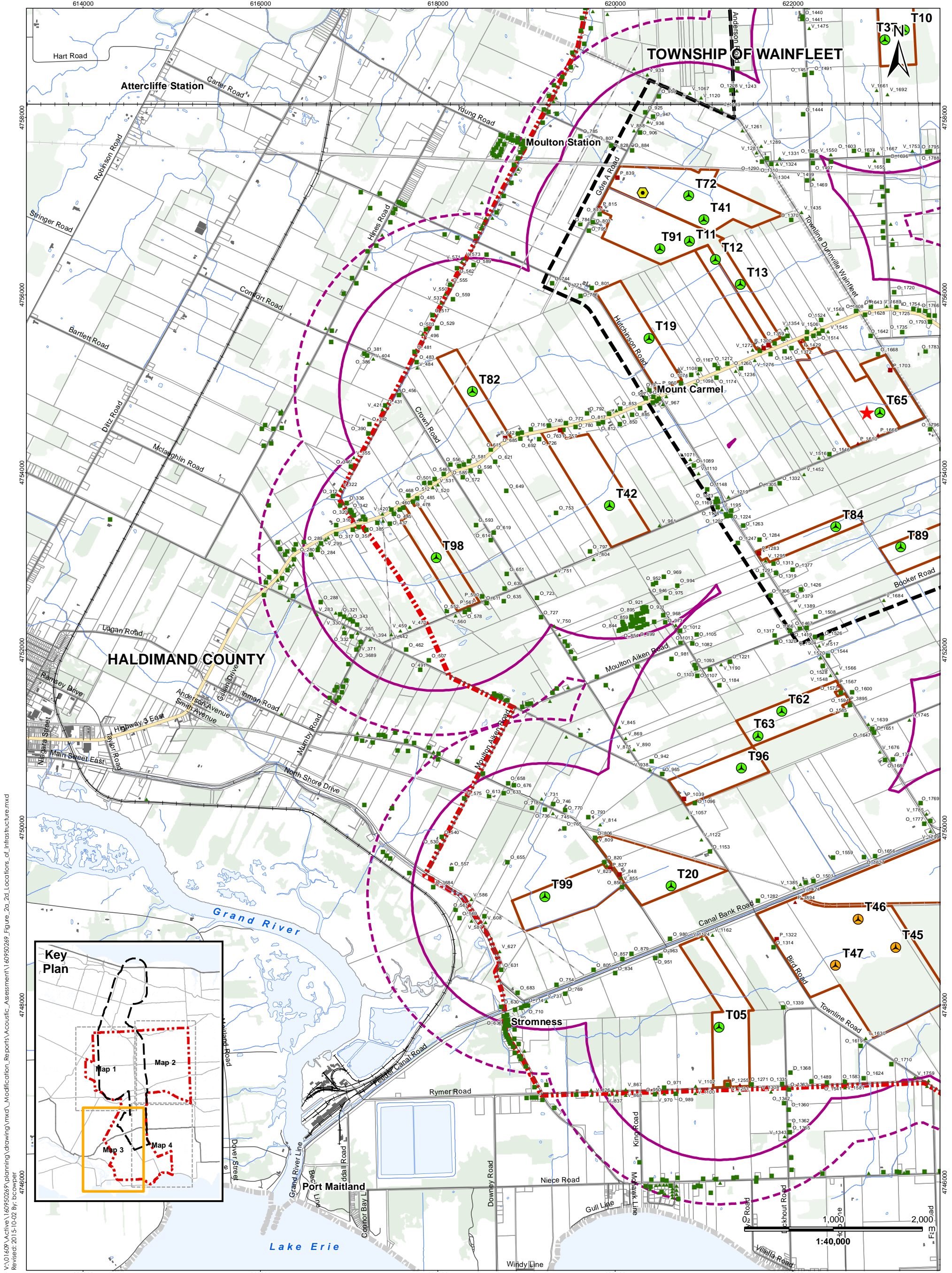

V:\01609\Projects\160950269\planning\drawing\mxd\Modification\_Reports\Acoustic\_Assessment\160950269\_Figure\_2a\_2d\_Locations\_of\_Infrastructure.mxd  
 Reviset: 2015-10-02 By: bcovner



- Legend**
- Project Study Area
  - Interconnector Study Area
  - Proposed Turbine Location - E101 3.0 MW
  - Proposed Turbine Location - E101 2.9 MW G2/G3
  - ★ Transformer Substation
  - ★ Tap-in Location
  - Existing Met Tower
  - 1.5 km Radius from Proposed Turbine Centre Point
  - 2km Radius from Proposed Turbine Centre Point
  - Road
  - Expressway / Highway
  - Active Railway
  - Abandoned Railway
  - Existing Transmission Line
  - Watercourse
  - Waterbody
  - Wooded Area
  - Municipal Boundary
  - Participating Noise Receptors - Occupied
  - ▲ Participating Noise Receptors - Vacant
  - Non-participating Noise Receptors - Occupied
  - ▲ Non-participating Noise Receptors - Vacant

Client/Project  
 FWRN LP  
 Niagara Region Wind Farm  
 Acoustic Assessment Report

October 2015  
 160950269

Figure No.  
 2.1c

Title  
 Locations of Project  
 Infrastructure within Study Area:  
 Map 3 of 4

- Notes**
1. Coordinate System: NAD 1983 UTM Zone 17N
  2. Base features produced under license with the Ontario Ministry of Natural Resources © Queen's Printer for Ontario, 2012.
  3. Scenario 1 - T36, T46, T53 are E82 model at hub height 135 metre; T18, T45, T47, T55, T60 and T74 are E101 model at hub height 135 metre and the rest are E101 model at hub height 124 metre. Scenario 2 - T36, T46, T53 are E82 model at hub height 135 metre; and the rest are E101 model at hub height 135 metre.



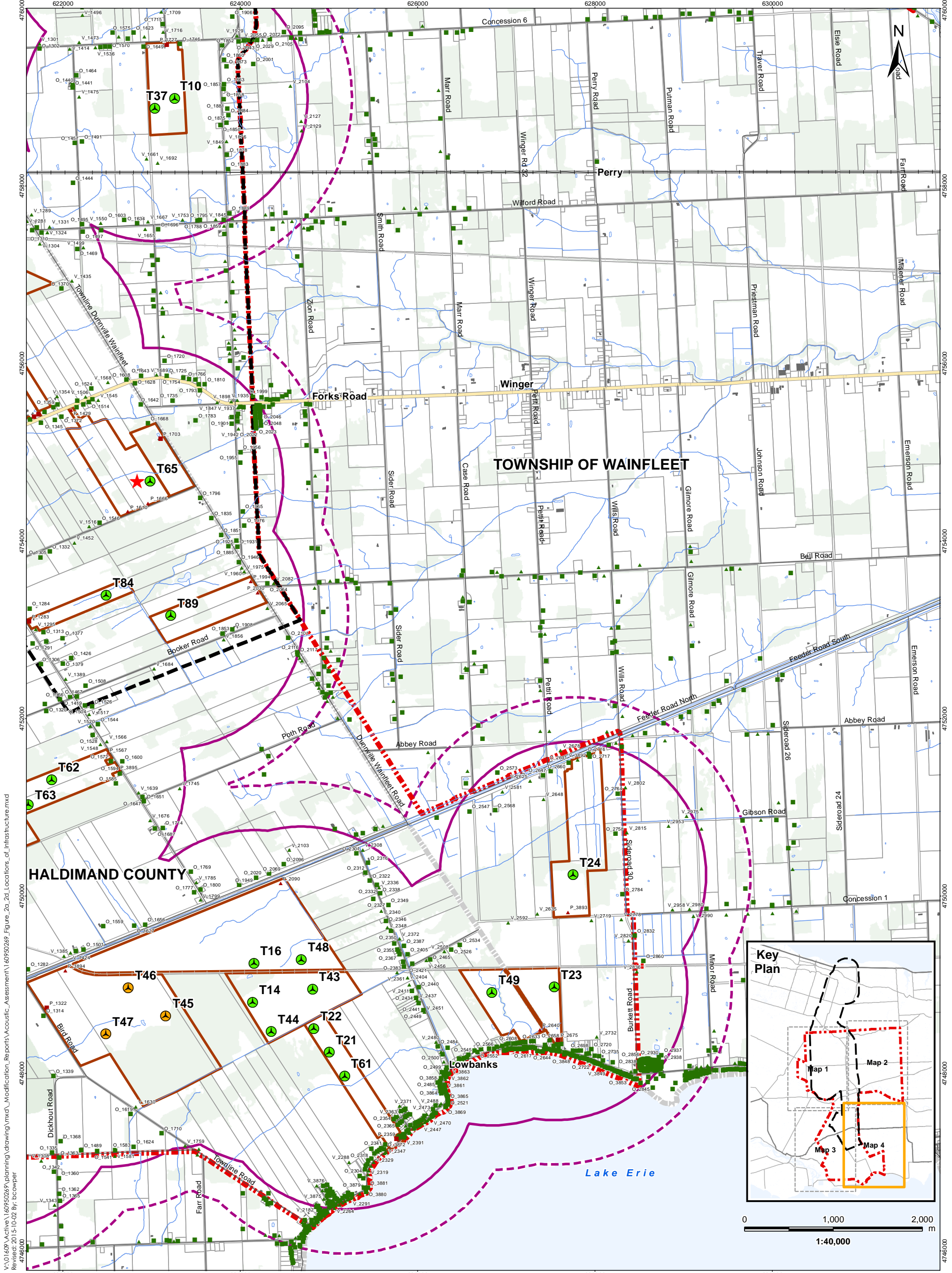

V:\01609\Projects\160950269\planning\drawing\mxd\Modification\_Reports\Acoustic\_Assessment\160950269\_Figure\_2a\_2d\_Locations\_of\_Infrastructure.mxd  
 Revised: 2015-10-02 By: bcowper



**Legend**

- |  |                            |                                   |
|--|----------------------------|-----------------------------------|
| Project Study Area                               | Road                       | Participating Noise Receptors     |
| Interconnector Study Area                        | Expressway / Highway       | Occupied                          |
| Proposed Turbine Location - E101 3.0 MW          | Active Railway             | Vacant                            |
| Proposed Turbine Location - E101 2.9 MW G2/G3    | Abandoned Railway          | Non-participating Noise Receptors |
| Transformer Substation                           | Existing Transmission Line | Occupied                          |
| Tap-in Location                                  | Watercourse                | Vacant                            |
| Existing Met Tower                               | Waterbody                  |                                   |
| 1.5 km Radius from Proposed Turbine Centre Point | Wooded Area                |                                   |
| 2km Radius from Proposed Turbine Centre Point    | Municipal Boundary         |                                   |

Client/Project  
 FWRN LP  
 Niagara Region Wind Farm  
 Acoustic Assessment Report

October 2015  
 160950269

**Notes**

- Coordinate System: NAD 1983 UTM Zone 17N
- Base features produced under license with the Ontario Ministry of Natural Resources © Queen's Printer for Ontario, 2012.
- Scenario 1 - T36, T46, T53 are E82 model at hub height 135 metre; T18, T45, T47, T55, T60 and T74 are E101 model at hub height 135 metre and the rest are E101 model at hub height 124 metre. Scenario 2 - T36, T46, T53 are E82 model at hub height 135 metre; and the rest are E101 model at hub height 135 metre.

Figure No.  
 2.1d

Title  
 Locations of Project Infrastructure within Study Area:  
 Map 4 of 4

## 3.0 Noise Source Summary

---

### 3.1 NOISE SOURCES

For the purpose of this Acoustic Assessment Report, the noise sources associated with the wind facility will consist of 80 WTGs (69 ENERCON E101 3.0 MW model and 11 customized E101 2.9 MW G2/G3 model), a 90 MVA transformer at the north substation and a 69 MVA transformer at the south substations. WTGs will operate throughout the year when wind conditions at hub height are within cut-in (2.5 m/s) and cut-out wind speeds (28 - 34 m/s). The noise sources associated with the WTGs were assessed for the scenario described in Section 2.4, and additional WTG specifications are provided in Table 2.1. The noise sources associated with both substation transformers were assessed at a height of 3.7 m at the identified locations. It was conservatively assumed that all equipment will operate at full rated capacity during the predictable worst case hour.

As discussed previously, eleven (11) of the turbines will be ENERCON customized E101 2.9 MW G2/G3 model and sixty-nine (69) will be ENERCON E101 3.0 MW model to meet the contractual requirements of the Project (maximum capacity not to exceed 230 MW).

Power is transferred from each turbine through an overhead and/or underground collection system to one of two transformer substations. Where two or more collector lines connect and continue as one collector line, a junction box or pad-mounted disconnect switch will be installed. These units are enclosed metal boxes approximately 2 m high, 3 m long and 2 m wide. There is no noise emission sources associated with the junction boxes.

The typical substation components include an isolation switch, circuit breakers, control and operation equipment. Transformers at both substations will be within confined boundaries. The transformer at the north substation will have a base rating of 90 MVA, while the transformer at the south substation will have a base rating of 69 MVA, both with two stages of cooling (via fan).

Noise emissions from the 90 MVA and 69 MVA transformers were identified by the design team to be less than the two 100 MVA transformers (100/133/166 ONAN/ONAF/ONAF MVA transformers). The more conservative noise emissions from the 100 MVA transformer approved for this Project were used for the purpose of updating the AAR. Consistent with the approved NAR (Stantec, September 2014), these noise emissions are assumed to have a distinct tonal character and were therefore assessed with a 5 dB penalty in the study.

At the transformer substations, voltage is stepped up from 34.5 kV to 115 kV. From the transformer substations, the power will be transferred via an overhead transmission line to interconnect with Hydro One Networks Inc's (HONI) transmission system at the tap-in location in the north end of the Interconnector Study Area. There are no noise sources associated with the collector and transmission lines.

Table 3.1 provides detailed sound emission data for the ENERCON E101 3.0 MW and customized E101 2.9 MW G2/G3 model WTGs and the corresponding test data from an independent consultant (KÖTTER Consulting Engineers for E101 3.0 MW model and T&H INGENIEURE GmnH for customized E101 2.9 MW G2/G3 model) engaged by the manufacturer (Enercon) is provided in Appendix D. Supplemental information confirming sound power data was provided by Enercon in April 2014 for E101 3.0 MW model and May 2015 for customized E101 2.9 MW G2/G3 model. These data have been included in Appendix D.

Table 3.2 provides the representative sound emission data from test data used in the analysis. Table 3.3 provides detailed sound emission data for the transformer substations. The noise sources for this Project are summarized in the Table 3.4 and illustrated in Figure 2.1. The UTM coordinates of each WTG and transformer substation are provided in Table 3.5 and Table 3.6. All sources are assumed to have continuous emissions when operating.

The sound power levels resulting from the operation of the transformers were estimated using the procedures outlined in the NEMA standard (NEMA PTR 1-1993 (R2000)). The approximate size of the transformers (100/133/166 ONAN/ONAF/ONAF MVA) previously included in the REA approval was used to estimate the sound power level. This calculation can be found in Appendix D. The design team indicated that the base rate of the transformers would be 90 MVA and 69 MVA respectively (less than 100 MVA) with two stages of cooling. The transformer sound emission data provided in Table 3.3 is therefore considered conservative.



**Table 3.1 Wind Turbine Sound Emission Summary**

**Make: ENERCON**  
**Model: E101 3.0 MW**  
**Electrical Rating: 3MW**  
**Hub Height: 124 m**  
**Data Source: Enercon (Appendix D)**

		Octave Band Sound Power Level (dB ref. 10 <sup>-12</sup> Watts)				
10m Height Wind Speed (m/s)		6 <sup>1</sup>	7 <sup>1</sup>	8 <sup>1</sup>	9 <sup>1</sup>	10 <sup>2</sup>
Frequency (Hz)	63	111.3	112	112.4	112.3	112.5
	125	106.5	107.2	107.6	107.5	107.7
	250	106	106.7	107.1	107	107.2
	500	102.8	103.5	103.9	103.8	104.0
	1000	97.1	97.8	98.2	98.1	98.3
	2000	90.4	91.1	91.5	91.4	91.6
	4000	83.7	84.4	84.8	84.7	85.0
	8000	73.2	73.9	74.3	74.2	74.4
Overall (dBA ref. 10 <sup>-12</sup> Watts)		103.6	104.3	104.7	104.6	104.8

**Make: ENERCON**  
**Model: Customized E101 2.9 MW G2/G3**  
**Electrical Rating: 2.9 MW**  
**Hub Height: 124 m**  
**Data Source: Enercon (Appendix D)**

		Octave Band Sound Power Level (dB ref. 10 <sup>-12</sup> Watts)				
10m Height Wind Speed (m/s)		6	7	8	9	10
Frequency (Hz)	63	109.2	111.1	111.9	109.9	109.9
	125	107.2	109.1	109.9	108.1	108.1
	250	103.7	105.6	106.4	104.7	104.7
	500	96.6	98.5	99.3	101.6	101.6
	1000	90.6	92.5	93.3	97	97
	2000	87	88.9	89.7	89	89
	4000	82.3	84.2	85	84.2	84.2
	8000	73.1	75	75.8	83	83
Overall (dBA ref. 10 <sup>-12</sup> Watts)		99.5	101.4	102.2.	102.9	102.9

<sup>1</sup> As per the data, overall sound power data is available from 6 m/s (corresponding to 1556 kW or approximately 53% of the rated power) to 8 m/s (corresponding to 2857 kW or approximately 97% of the rated power of 2.9 MW). As per the data, the maximum sound power level occurs at 9 m/s wind speed and corresponding spectral data is given in the data sheet. The spectral data for 6 m/s wind speed was obtained by scaling based on the overall data.

<sup>2</sup> No data was given previously for the 10 m/s wind speed since the turbine reaches 95% of rated power output at 8.3 m/s wind speed. For this model the attached test report indicates that the maximum sound power level occurs at 8.3 m/s wind speed and Enercon confirms that this level will not be exceeded. The maximum sound power level as provided from manufacturer was used (Appendix D, G). A wind shear adjusted sound data is provided in Appendix F.

**Table 3.2 Highest Wind Turbine Sound Emission Corresponding to 95% or above Rated Electrical Output Power**

Description	Octave Band Sound Power Level (dB ref. 10-12 Watts)								
	63	125	250	500	1k	2k	4k	8k	dB/dBA
ENERCON model E101 3.0 MW model at 8.3 m/s	112.5	107.7	107.2	104.0	98.3	91.6	85	74.4	113.9/ 104.8
ENERCON model E101 2.9 MW G2/G3 model at 9 m/s	83.7	92	96.1	98.4	97	90.2	85.2	81.9	113.3/ 102.9

**Table 3.3 Substation Transformer Sound Emission Data**

Description	Octave band center frequency [Hz]								
	63	125	250	500	1k	2k	4k	8k	dB/dBA
100/133/166 ONAN/ONAF/ONAF MVA Transformers Sound power Levels [dB ref 10 <sup>-12</sup> watt]*	94	100	102	97	97	91	86	81	104.1/98.2

*\*A 5 dBA penalty was applied to transformer component of sound pressure level at each POR as discussed below.*

*The transformers were revised to 90 MVA and 69 MVA, however data previously approved for 100 MVA was used in the model.*



**Table 3.4 Noise Source Summary Table**

Source ID	Source Type <sup>1</sup>	Source Description	Sound Power Level [dBA]	Source Location (I/O) <sup>2</sup>	Sound Characteristics <sup>3,5</sup>	Noise Control Measures <sup>4</sup>
T18, T36, T45, T46, T47, T53, T55, T60, T74	P	ENERCON customized model E101 G2/G3 WTG	102.9	O	S	U
All Turbines except T18, T36, T45, T46, T47, T53, T55, T60, & T74	P	ENERCON model E101 WTG	104.8	O	S	U
ST1	P	90 MVA Transformer <sup>6</sup>	98(T)	O	T	B
ST2	P	69 MVA Transformer <sup>6</sup>	98(T)	O	T	B

1. P = Point Source V = Vertical Source VA = Vertical Area Source
2. Source Location: O = outside of building; I = inside of building
3. Sound Character, per NPC-104:
 

T = Tonal	C = Cyclical
S = Steady	Q = Quasi-Steady Impulsive
B = Buzzing	I = Impulsive
4. Noise Control Measures:
 

S = Silencer/Muffler	L = Lagging
A = Acoustic Lining, plenum	O = Other
U = Uncontrolled	B = Barrier
E = Acoustic Enclosure	
5. Includes 5 dB penalty for tonality, for source marked with T
6. Previously used 100 MVA estimate data was used.

**Table 3.5 Wind Turbine Locations**

Turbine Identifier	Make and Model	Hub Height [m]	Location Coordinates (UTM 17 NAD 83)	
			X – Easting [m]	Y-Northing [m]
T01	ENERCON E101	124	622986	4765745
T02	ENERCON E101	124	627380	4765942
T03	ENERCON E101	124	629891	4763588
T04	ENERCON E101	124	627524	4767740
T05	ENERCON E101	124	621171	4747754
T06	ENERCON E101	124	623096	4767244
T07	ENERCON E101	124	618636	4764053
T08	ENERCON E101	124	614545	4764911
T09	ENERCON E101	124	616790	4762576
T10	ENERCON E101	124	623259	4758990
T11	ENERCON E101	124	620836	4756609
T12	ENERCON E101	124	621135	4756407
T13	ENERCON E101	124	621410	4756122

Table 3.5 Wind Turbine Locations

Turbine Identifier	Make and Model	Hub Height [m]	Location Coordinates (UTM 17 NAD 83)	
			X – Easting [m]	Y-Northing [m]
T14	ENERCON E101	124	624137	4748807
T16	ENERCON E101	124	624153	4749243
T18	E101 2.9 MW G2/G3	124	630123	4766229
T19	ENERCON E101	124	620380	4755516
T20	ENERCON E101	124	620627	4749341
T21	ENERCON E101	124	625004	4748242
T22	ENERCON E101	124	624829	4748510
T23	ENERCON E101	124	627540	4748974
T24	ENERCON E101	124	627752	4750239
T27	ENERCON E101	124	622535	4768708
T28	ENERCON E101	124	622517	4769096
T29	ENERCON E101	124	628498	4763100
T31	ENERCON E101	124	625150	4765821
T32	ENERCON E101	124	624781	4764410
T33	E101 2.9 MW G2/G3	124	626969	4765950
T34	E101 2.9 MW G2/G3	124	626486	4764591
T35	ENERCON E101	124	627164	4764483
T36	E101 2.9 MW G2/G3	124	622379	4763063
T37	ENERCON E101	124	623038	4758881
T38	ENERCON E101	124	620669	4765752
T39	ENERCON E101	124	617349	4764279
T41	ENERCON E101	124	620998	4756851
T42	ENERCON E101	124	619935	4753628
T43	ENERCON E101	124	624815	4748952
T44	ENERCON E101	124	624350	4748471
T45	E101 2.9 MW G2/G3	124	623160	4748650
T46	E101 2.9 MW G2/G3	124	622737	4748968
T47	E101 2.9 MW G2/G3	124	622483	4748447
T48	ENERCON E101	124	624687	4749283
T49	ENERCON E101	124	626836	4748915
T51	ENERCON E101	124	617020	4762752
T52	ENERCON E101	124	614215	4766531
T53	E101 2.9 MW G2/G3	124	614456	4766402
T54	ENERCON E101	124	619944	4765594
T55	E101 2.9 MW G2/G3	124	623610	4764393
T56	ENERCON E101	124	626599	4768825

**Table 3.5 Wind Turbine Locations**

Turbine Identifier	Make and Model	Hub Height [m]	Location Coordinates (UTM 17 NAD 83)	
			X – Easting [m]	Y-Northing [m]
T57	ENERCON E101	124	624435	4768696
T58	ENERCON E101	124	628473	4767629
T59	ENERCON E101	124	629964	4767676
T60	E101 2.9 MW G2/G3	124	630277	4767682
T61	ENERCON E101	124	625177	4747970
T62	ENERCON E101	124	621877	4751311
T63	ENERCON E101	124	621609	4751032
T65	ENERCON E101	124	622984	4754679
T66	ENERCON E101	124	619127	4768529
T72	ENERCON E101	124	620828	4757122
T74	E101 2.9 MW G2/G3	124	621656	4763002
T75	ENERCON E101	124	621357	4764543
T76	ENERCON E101	124	623640	4765719
T78	ENERCON E101	124	628581	4764783
T79	ENERCON E101	124	630384	4771637
T80	ENERCON E101	124	630186	4771984
T81	ENERCON E101	124	616343	4766967
T82	ENERCON E101	124	618390	4754915
T83	ENERCON E101	124	615821	4770715
T84	ENERCON E101	124	622487	4753393
T85	ENERCON E101	124	619136	4769108
T88	ENERCON E101	124	615816	4771059
T89	ENERCON E101	124	623216	4753160
T91	ENERCON E101	124	620504	4756521
T93	ENERCON E101	124	618324	4767127
T94	ENERCON E101	124	618752	4768764
T95	ENERCON E101	124	622817	4760851
T96	ENERCON E101	124	621423	4750668
T97	ENERCON E101	124	617215	4765642
T98	ENERCON E101	124	617982	4753043
T99	ENERCON E101	124	619208	4749224

\*Note: “ENERCON E101” refers to the ENERCON E101 3MW model turbine, as previously approved, while “E101 2.9 MW G2/G3” refers to the customized ENERCON E101 2.9 MW model turbine.

**Table 3.6 Substation Transformer Locations**

Transformer Identifier	Transformer Type	Height [m]	Location Coordinates (UTM 17 NAD 83)	
			X – Easting [m]	Y-Northing [m]
ST1	90 MVA Transformer	3.7	621960	4761728
ST2	69 MVA Transformer	3.7	622837	4754679

### 3.2 SOUND CHARACTER ADJUSTMENTS

The MOE guideline NPC-104 outlines that the sources with distinct sound characteristics are to be penalized in the assessment. In accordance with this guideline, the resulting noise emissions associated with transformers were penalized by 5 dB to account for potential hum from transformer coils.

### 3.3 CUMULATIVE EFFECTS

As per the guideline requirements, cumulative effects due to other existing or crystallized wind farms have been included in this assessment. Four other existing or proposed wind farms were identified and included as having components within 5.0 km of the project WTGs. Existing turbines within this setback include the Mohawk wind farm located to the south of the project and the Rosa Flora wind turbine to the west of the project. Wind energy projects currently in development (either proposed or approved) within the 5 km setback distance include the HAF Wind Energy project to the west of the Project, the Wainfleet wind energy project to the southeast and the Grand Renewable Energy Project to the southwest. Details of these projects are included in Table 3.7 and Table 3.8. Additional wind farms considered but not included in this assessment as they were outside of the required 5 km setback include the Byng Wind Project and the Summerhaven Wind Energy Centre.

**Table 3.7 Adjacent Wind Farms within 5 km of the Project**

Wind farm identifier	Existing/ Approved	Turbine Model	Number of Turbines	Number of Turbines within 5 km of the Project
Mohawk Wind Farm	Existing	V82-1.65 MW-Vestas	6	6
HAF Wind Energy	Proposed	V100 1.8 MW	5	5
Wainfleet Wind Energy	Proposed	V100 1.8 MW	5	5
Rosa Flora Turbine	Existing	PWE 650	1	1
Grand Renewable Energy Project	Proposed	SWT-2.221-101 Siemens	67	6

The following table provides the location and coordinates of the adjacent wind turbines that were considered in the noise assessment. The location (UTM coordinates), and the sound data were taken from reports and developers submittals (refer Appendix F for details).

**Table 3.8 Assessed Noise Sources Associated with Adjacent or Proposed Wind Farms within 5 km**

Source ID	Source Description	Sound Power Level [dBA]	UTM Coordinates		
			X [m]	Y [m]	Z [m]
HAF01	HAF01(HAF Wind Energy Project)	105	604702	4775503	95
HAF02	HAF02(HAF Wind Energy Project)	105	604889	4775137	95
HAF03	HAF03(HAF Wind Energy Project)	105	606276	4774896	95
HAF04	HAF04(HAF Wind Energy Project)	105	604359	4774307	95
HAF05	HAF05(HAF Wind Energy Project)	105	606208	4773395	95
MH01	Mohawk01(V82-1.65 MW-Vestas)	102	623355	4745400	80
MH02	Mohawk02(V82-1.65 MW-Vestas)	102	622632	4746480	80
MH03	Mohawk03(V82-1.65 MW-Vestas)	102	623974	4745737	80
MH04	Mohawk04(V82-1.65 MW-Vestas)	102	623297	4746604	80
MH05	Mohawk05(V82-1.65 MW-Vestas)	102	623047	4746843	80
MH06	Mohawk06(V82-1.65 MW-Vestas)	102	622661	4745529	80
WF01	WF01(Wainfleet Wind Energy Project)	105	631359	4751252	95
WF02	WF02(Wainfleet Wind Energy Project)	105	631758	4750750	95
WF03	WF03(Wainfleet Wind Energy Project)	105	631921	4750541	95
WF04	WF04(Wainfleet Wind Energy Project)	105	632750	4748389	95
WF05	WF05(Wainfleet Wind Energy Project)	105	632706	4748817	95
RF	Rosa Flora Turbine	103.5	615270	4756417	75
GREPT57	SWT-2.221-101 - Grand Renewable	105	614355	4748118	100
GREPT58	SWT-2.221-101 - Grand Renewable	105	614974	4747470	100
GREPT59	SWT-2.221-101 - Grand Renewable	105	614326	4747732	100
GREPT60	SWT-2.221-101 - Grand Renewable	105	614680	4748176	100
GREPT61	SWT-2.221-101 - Grand Renewable	105	614750	4747811	100
GREPT62	SWT-2.221-101 - Grand Renewable	105	614705	4747338	100

- Grand Renewable Locations and data are based on Noise Assessment report by Zephyr North dated July 11, 2011;
- Mohawk location is based on construction drawing (Appendix F) and manufacturer's data (Appendix F);
- HAF Wind Energy project Locations and data are based REA report package dated November 26, 2010;
- WainFleet Wind Energy Project is based on REA package dated November, 2010; and
- Rosa Flora: This is a single small turbine. The location is based on as built location and the sound data was taken as 103.5 dBA (slightly higher than a 2.3 MW E82 model turbine). This turbine is located approximately 3,500 metres away from NRWC's nearest turbine. In addition, this is a 650 kW turbine that does not feed into the Ontario grid (i.e. electricity is delivered directly into the Rosa Flora system). Therefore, the assumption is considered very conservative. This turbine is included for completeness.

## 4.0 Points of Reception

---

### 4.1 DEFINITION OF A POINT OF RECEPTION

Points of Reception (PORs) were categorized into four groups for the assessment:

1. Non-participating occupied receptors – an existing building or structure that contains one or more dwellings, an existing building or structure used for an institutional purpose (i.e., education facility, nursery, health care facility, place of worship), a campsite or campground;
2. Non-participating vacant lot receptors – a lot with no existing building or structure containing a dwelling or institutional facility (i.e. not currently used as a dwelling or institutional facility) but is zoned to permit a building which could be a dwelling or institutional facility;
3. Participating occupied receptors – an existing building or structure that contains one or more dwellings and is on the same legal property as proposed Project components; and,
4. Participating vacant lot receptors - a lot with no existing building or structure containing a dwelling or institution facility but is zoned to permit a building which could be a dwelling or institutional facility and is on the same legal property as proposed Project components.

Receptors were defined based on field verifications, review of parcel data, information from planners of respective Townships or Counties, and recent aerial imagery. Stantec undertook extensive field verification to validate existing occupied PORs. All non-participating and participating receptors within 2 km of the Project WTGs as of the date August 15, 2012, were identified as receptors in the September 2014 AAR report as per O.Reg 359/09 Section 54 (1.4). On August 15, 2012, the layout of the Project turbines and all receptors were crystallized through the publication of the WTG coordinates and receptors in a Draft Site Plan Report in local newspapers and online.

The PORs were provided with a unique numbering system in the form of X\_### (e.g. P\_2587). In this identification system the character X represents the following:

- ‘O’ represents **non-participating occupied** receptors;
- ‘V’ represents **non-participating vacant lot** receptors; and,
- ‘P’ represents **participating occupied/vacant lot** receptors;

Whereas the numbers ### – represents a unique identification number for each receptor. Additional rational for individual receptors that were referenced in MOE and EBR comments are included in **Appendix G**.

The noise guideline (PIBs 4709) requires that PORs be identified on vacant lots that have been zoned by the local municipality to permit residential or similar noise-sensitive uses. The legal lot/parcel data were used to determine the lot boundaries and thereby identify all vacant lots within 2 km of the Project. All vacant lots were assigned a unique POR identification number. The points of assessment for vacant lots were chosen to match the local development patterns.

## **4.2 EXISTING POINTS OF RECEPTION**

All non-participating PORs meet or exceed the minimum requirement of 550 metre setback requirement from the centre point of the WTGs. All receptors were modeled using a height of 4.5 meters. The type and coordinates of the receptors are summarized in **Appendix C**.

Figure 1.1 and Figure 2.1 show the locations of all PORs within 2 km of the WTGs as required by Section 6.1 of 4709e. As required by Section 6.4.1 of 4709e; the noise assessment considers the sound levels at the 2670 PORs within 1.5 km of the Project WTG locations as described below:

1. 2036 non-participating occupied receptors;
2. 539 non-participating vacant lot receptors; and
3. 95 participating occupied/vacant lot receptors.

Previously POR 2550 was considered as a participating receptor and was given identification P\_2550. However, through detailed design, this receptor has been removed from the Project and is now considered a non-participating receptor, where the receptor ID has been changed to O\_2550 ( “occupied and non-participating”) and assessed in this AAR accordingly.

For the purposes of this report, the ten (10) representative non-participating receptors, which through modeling were predicted to have the highest sound levels as a result of the Project noise sources, were shown in the previous AAR (Stantec, September 2014) and are shown below. The locations of these ten (10) receptors are summarized in Table 4.1, and the results for the remaining modeled PORs are provided in **Appendix C**.



**Table 4.1      Nearby Points of Reception**

POR ID	Description	UTM Coordinates		POR Height (m)	Approximate Distance to Nearest Facility Turbine (m)	Nearest Facility Turbine ID
		X	Y			
O_1097	Existing occupied dwelling	620899	4764949	4.5	612	T75
O_1153	Existing occupied dwelling	621067	4749725		584	T20
O_1344	Existing occupied dwelling	621910	4768894		640	T28
O_1707	Existing occupied dwelling	623108	4766469		734	T01
O_2160	Existing occupied dwelling	624777	4765059		649	T32
O_2522	Existing occupied dwelling	626354	4765297		718	T34
O_2598	Existing occupied dwelling	627060	4763919		573	T35
O_2690	Existing occupied dwelling	627693	4764983		728	T35
O_2710	Existing occupied dwelling	627899	4765540		657	T02
O_3030	Existing occupied dwelling	629320	4767722		646	T59

## 5.0 Noise Assessment Criteria

---

### 5.1 MOE GUIDELINE LIMITS

As discussed, the Project and its surroundings are considered to be located in a Class 3 (Rural) acoustical environment. The sounds of the ambient environment are expected to be dominated by natural sounds with little road traffic and minimal industrial activities. There is an industrial facility located in Haldimand County (near Mohawk Wind Farm), which dominates its surroundings. However, noises from this industrial facility are not considered in this assessment.

Table 5.1 shows the performance limits for wind turbines in Class 3 areas as outlined in PIBs 4709e.

**Table 5.1 Wind Turbine Sound Pressure Limits for Class 3 Area**

Wind Speed at 10 m height [m/s]	4	5	6	7	8	9	10
Wind Turbine sound pressure limits [dBA]	40.0	40.0	40.0	43.0	45.0	49.0	51.0

The analysis also includes other requirements from this guideline such as a 5 dB penalty on transformer noise to account for tonality, and use of a ground absorption co-efficient of 0.7 as discussed further in Section 6.1. In addition, the guideline requires that all adjacent wind farm WTGs within 5 km of any Project WTG must be considered for cumulative effects in evaluating sound pressure levels. To assess noise levels for this Project, wind turbine noise emissions were assessed against the most restrictive sound pressure level limit of 40.0 dBA.

## 6.0 Impact Assessment

---

### 6.1 METHODOLOGY

A predictive analysis was performed using the commercially available software package CADNA/A, which implements a computerized version of the algorithms described in the ISO 9613 standard. The ISO 9613 model includes geometrical divergence (distance attenuation), barrier effects due to intervening structures, ground effects, atmospheric absorption, and topography. No shielding/barriers such as existing buildings other than the barriers recommended for the transformer substation were considered in the assessment.

All sound sources (turbines and transformers) that emit noise into the environment were modeled as point sources. Topography was included in the model; however, the study area is relatively flat and topography is not expected to have a significant influence on the results. No shielding or obstacles were included in the model other than the barriers recommended for the transformer substations.

The Facility and surrounding ground surfaces were modeled as a combination of reflective and absorptive as specified in the MOE guideline. The analysis utilizes a global ground sound absorption factor of 0.7. Considering the study area is generally agricultural in nature, the actual absorption factor is expected to be closer to 1.0.

Meteorological values as required by PIBs 4709e were used to initialize several parameters in the model. These included a temperature of 10 degrees Centigrade and a relative humidity of 70%. The calculations consider spectral values of the sound data in 1/1 octave bands between 63 Hz and 8000 Hz as discussed in Section 3. As per the requirements of PIBs 4709e, the atmospheric absorption coefficients shown in Table 6.1 were used.

---

**Table 6.1 Atmospheric Absorption Coefficient (based on 10 degree Celsius and 70% Relative Humidity)**

Octave band center frequency [Hz]	63	125	250	500	1000	2000	4000	8000
Recommended atmospheric absorption coefficient [dB/km]	0.1	0.4	1.0	1.9	3.7	9.7	32.8	117

As described in Section (Operation Scenario), this assessment considers all WTGs running at full rated capacity for one full hour irrespective of wind conditions. An example of the detailed model calculations is included in **Appendix E**.

## 6.2 RESULTS AND RECOMMENDATIONS

The modeled results (Project effects and cumulative effects) at the identified PORs during predictable worst case operation are provided in Table 6.2 for the selected PORs. For the remaining PORs, a similar table is included in **Appendix C**. The corresponding equivalent sound level contours are provided in Figure 6.1.

Compliance at nearby PORs was established using noise barriers for both of the two transformer substations (previously used 100 MVA data estimated was used). The detailed requirements for noise barriers are as follows:

1. Substation ST1 (100/133/166 ONAN/ONAF/ONAF MVA Transformer noise source modeled (instead of 90 MVA) at a height of 3.7m with UTM Coordinates 621960, 4761728) will require a four sided barrier of 4.5 metres in height above grade. Barrier corner coordinates are provided in Appendix F
2. Substation ST2 (100/133/166 ONAN/ONAF/ONAF MVA Transformer noise source modeled (instead of 69 MVA) at a height of 3.7m with UTM Coordinates 622837, 4754679) will require a two sided barrier of 4.5 metres in height above grade. This barrier should be placed on south and west side of the transformer and extended at least 2 meters beyond the transformer such that noise flanking is negligible. Barrier corner coordinates are provided in Appendix F.

The barrier could be constructed with a variety of different materials including masonry or composite materials provided that they meet electrical and fire safety requirements. The barriers should be constructed within a 2 metre setback from the transformers. The selected material should achieve a minimum surface density of 20 kilograms per square meter ( $\text{kg/m}^2$ ). The barrier should be built considering environmental factors specific to the location such as wind load and snow load so that the barrier is durable and can be maintained with minimal effort. The barrier should be constructed without any gaps within or below its extent.

### 6.2.1 Project and Cumulative Effects

The project and cumulative effects were assessed and the results are shown in the following table. As discussed previously, cumulative effects due to other existing or crystallized wind farms have been included in this assessment. Four other existing or proposed wind farms were identified and included as having components within 5.0 km of the project receptors. Among the four only Mohawk Point Turbines have mutual PORs within 1.5 km from WTGs. A Noise Assessment Report for Mohawk Point Turbines is not available. Based on published locations, model and manufacturers data related to hub height and sound emissions, contributions with and without the Mohawk Point Turbines on mutual PORs were assessed and provided in Table 6.3.

**Table 6.2 Noise Impact Assessment Summary Table\***

POR ID	POR Description	Project Effects - Sound Level at POR (Leq, 4.5m)	Cumulative Effects - Sound Level at POR (Leq, 4.5m)	Performance Limit (Leq, dBA)	Compliance with Performance Limit? (Project/Cumulative)
O_1097	Existing occupied dwelling	40.0	40.0	40.0	Y/Y
O_1153	Existing occupied dwelling	39.9	39.9		Y/Y
O_1344	Existing occupied dwelling	40.0	40.0		Y/Y
O_1707	Existing occupied dwelling	39.9	39.9		Y/Y
O_2160	Existing occupied dwelling	39.8	39.8		Y/Y
O_2522	Existing occupied dwelling	238.9	38.9		Y/Y
O_2598	Existing occupied dwelling	39.6	39.6		Y/Y
O_2690	Existing occupied dwelling	39.7	39.7		Y/Y
O_2710	Existing occupied dwelling	39.6	39.6		Y/Y
O_3030	Existing occupied dwelling	39.6	39.6		Y/Y

\* Results for all receptors are provided in **Appendix C**.



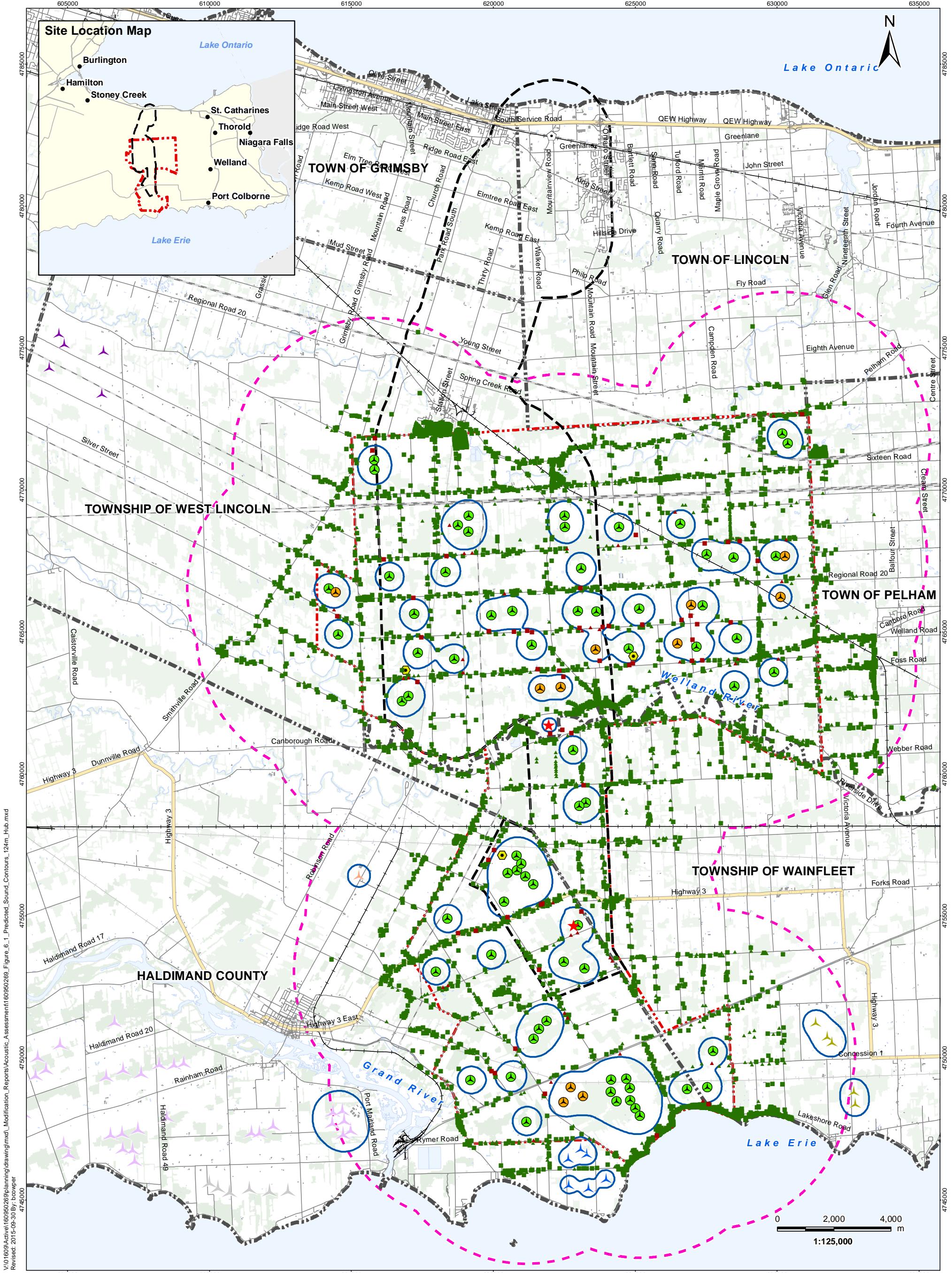

V:\1609\Active\160950268\planning\drawing\mxd\_Modification\_Reports\Acoustic\_Assessment\160950268\_Figure\_6.1\_Predicted\_Sound\_Contours\_124m\_Hub.mxd  
 Revised: 2015-09-30 By: bczwper



**Legend**

- |  |   |  |  |
|--|---|--|--|
| <ul style="list-style-type: none"> <li><span style="color: red; font-weight: bold;">▬</span> Project Study Area</li> <li><span style="border: 1px dashed black; padding: 2px;"> </span> Interconnector Study Area</li> <li><span style="color: green; font-size: 1.2em;">●</span> Proposed Turbine Location - E101 3.0 MW</li> <li><span style="color: orange; font-size: 1.2em;">●</span> Proposed Turbine Location - E101 2.9 MW G2/G3</li> <li><span style="color: red; font-size: 1.2em;">★</span> Transformer Substation</li> <li><span style="border: 1px solid black; border-radius: 50%; padding: 2px;"> </span> Tap-in Location</li> <li><span style="color: yellow; font-size: 1.2em;">●</span> Existing Met Tower</li> <li><span style="border: 1px dashed magenta; padding: 2px;"> </span> 5km Buffer from Proposed Turbine Locations</li> <li><span style="color: blue; font-weight: bold;">▬</span> Sound Level Contours (40 dBA)</li> </ul> | <ul style="list-style-type: none"> <li><span style="color: grey; font-weight: bold;">▬</span> Road</li> <li><span style="color: orange; font-weight: bold;">▬</span> Expressway / Highway</li> <li><span style="color: grey; font-weight: bold;">▬</span> Active Railway</li> <li><span style="color: grey; font-weight: bold;">▬</span> Abandoned Railway</li> <li><span style="color: grey; font-weight: bold;">▬</span> Existing Structures</li> <li><span style="color: grey; font-weight: bold;">▬</span> Existing Transmission Line</li> <li><span style="color: lightblue; font-weight: bold;">▬</span> Waterbody</li> <li><span style="color: lightgreen; font-weight: bold;">▬</span> Wooded Area</li> <li><span style="border: 1px dashed black; padding: 2px;"> </span> Municipality Lower Tier</li> </ul> | <ul style="list-style-type: none"> <li><span style="color: red; font-size: 1.2em;">■</span> Participating Noise Receptors - Occupied</li> <li><span style="color: red; font-size: 1.2em;">▲</span> Participating Noise Receptors - Vacant</li> <li><span style="color: green; font-size: 1.2em;">■</span> Non-participating Receptors - Occupied</li> <li><span style="color: green; font-size: 1.2em;">▲</span> Non-participating Receptors - Vacant</li> </ul> | <ul style="list-style-type: none"> <li><span style="color: blue; font-size: 1.2em;">▲</span> Other Wind Turbines - Mohawk Wind Farm (Existing)</li> <li><span style="color: orange; font-size: 1.2em;">▲</span> Other Wind Turbines - Rosa Flora Turbine (Existing)</li> <li><span style="color: yellow; font-size: 1.2em;">▲</span> Other Wind Turbines - Wainfleet Wind Energy Project (Proposed)</li> <li><span style="color: purple; font-size: 1.2em;">▲</span> Other Wind Turbines - HAF Wind Energy Project (Proposed)</li> <li><span style="color: purple; font-size: 1.2em;">▲</span> Other Wind Turbines - Grand Renewable Energy Park (Proposed)</li> <li><span style="color: grey; font-size: 1.2em;">▲</span> Other Wind Farm Project (Proposed)</li> </ul> |
|--|---|--|--|

**Notes**

- Coordinate System: NAD 1983 UTM Zone 17N
- Base features produced under license with the Ontario Ministry of Natural Resources © Queen's Printer for Ontario, 2012.

Client/Project  
 FWRN LP  
 Niagara Region Wind Farm  
 Acoustic Assessment Report

Figure No.  
**6.1**

**Predicted Equivalent Sound Level Contours (Cumulative Effects - Day/Nighttime Hours)**

September 2015  
 160950269

Table 6.3 Concordance Table for all adjacent wind farms - Scenario 1

POR UTM Coordinates		POR ID					Distance to nearest source (m)					Nearest Source ID					Level of Farm (dBA)					Level (dBA)
Easting (m)	Northing (m)	NRWC	MH	WF	RF	GREP	NRWC	MH	WF	RF	GREP	NRWC	MH	WF	RF	GREP	NRWC	MH	WF	RF	GREP	Total
621267.9	4747098.77	O_1215	not_avi	n/a	n/a	n/a	662.35637	1517.7486	>2000	>2000	>2000	T05	MH02	n/a	n/a	n/a	37.3	23.5	n/a	n/a	n/a	37.5
621536.63	4747106.47	O_1271	not_avi	n/a	n/a	n/a	743.62652	1283.8918	>2000	>2000	>2000	T05	MH02	n/a	n/a	n/a	36.6	25.5	n/a	n/a	n/a	36.9
621879.3	4747111.49	O_1335	not_avi	n/a	n/a	n/a	956.29911	1008.0841	>2000	>2000	>2000	T05	MH02	n/a	n/a	n/a	35.3	28.4	n/a	n/a	n/a	36.1
621901.22	4746889.27	O_1342	not_avi	n/a	n/a	n/a	1131.8035	859.50801	>2000	>2000	>2000	T05	MH02	n/a	n/a	n/a	34	29.9	n/a	n/a	n/a	35.4
621954.32	4746822.04	O_1360	not_avi	n/a	n/a	n/a	1217.4316	780.10949	>2000	>2000	>2000	T05	MH02	n/a	n/a	n/a	33.6	30.8	n/a	n/a	n/a	35.4
621958.35	4746643.27	O_1362	not_avi	n/a	n/a	n/a	1361.4849	708.51959	>2000	>2000	>2000	T05	MH02	n/a	n/a	n/a	32.7	31.7	n/a	n/a	n/a	35.2
621959.6	4747047.77	O_1363	not_avi	n/a	n/a	n/a	1058.6079	905.68931	>2000	>2000	>2000	T05	MH02	n/a	n/a	n/a	34.8	29.6	n/a	n/a	n/a	35.9
621966.59	4746565.46	O_1365	not_avi	n/a	n/a	n/a	1430.2415	683.23644	>2000	>2000	>2000	T05	MH02	n/a	n/a	n/a	32.3	32.1	n/a	n/a	n/a	35.2
621975.85	4747235.78	O_1368	not_avi	n/a	n/a	n/a	957.25414	1028.8564	>2000	>2000	>2000	T05	MH02	n/a	n/a	n/a	35.7	28.5	n/a	n/a	n/a	36.5
622209.61	4747132.76	O_1489	not_avi	n/a	n/a	n/a	1210.2272	807.09155	>2000	>2000	>2000	T05	MH02	n/a	n/a	n/a	34.7	31.3	n/a	n/a	n/a	36.3
622385.54	4747127.77	O_1541	not_avi	n/a	n/a	n/a	1322.7457	723.96275	>2000	>2000	>2000	T47	MH02	n/a	n/a	n/a	34.6	33	n/a	n/a	n/a	36.9
622589.1	4747137.77	O_1583	not_avi	n/a	n/a	n/a	1313.4629	596.84523	>2000	>2000	>2000	T47	MH05	n/a	n/a	n/a	34.6	34.8	n/a	n/a	n/a	37.7
622764.91	4747539.51	O_1619	not_avi	n/a	n/a	n/a	950.24082	808.19882	>2000	>2000	>2000	T47	MH05	n/a	n/a	n/a	36.7	30.9	n/a	n/a	n/a	37.7
622797.92	4747175.09	O_1624	not_avi	n/a	n/a	n/a	1310.2799	472.35075	>2000	>2000	>2000	T47	MH05	n/a	n/a	n/a	34.9	36.4	n/a	n/a	n/a	38.7
623112.64	4747327.61	O_1710	not_avi	n/a	n/a	n/a	1284.3238	534.79888	>2000	>2000	>2000	T47	MH05	n/a	n/a	n/a	35.9	35	n/a	n/a	n/a	38.5
624879.11	4746506.43	O_2191	not_avi	n/a	n/a	n/a	1493.5781	1187.959	>2000	>2000	>2000	T61	MH03	n/a	n/a	n/a	33.8	26.2	n/a	n/a	n/a	34.5
624935.11	4746735.56	O_2212	not_avi	n/a	n/a	n/a	1257.9161	1385.949	>2000	>2000	>2000	T61	MH03	n/a	n/a	n/a	35.2	24.9	n/a	n/a	n/a	35.6
624970.04	4746685.29	O_2226	not_avi	n/a	n/a	n/a	1301.2733	1375.2635	>2000	>2000	>2000	T61	MH03	n/a	n/a	n/a	34.9	24.8	n/a	n/a	n/a	35.3
624978.66	4746621.52	O_2231	not_avi	n/a	n/a	n/a	1362.9883	1338.5505	>2000	>2000	>2000	T61	MH03	n/a	n/a	n/a	34.5	25	n/a	n/a	n/a	35.0
624981.68	4746745.08	O_2234	not_avi	n/a	n/a	n/a	1240.3947	1425.3576	>2000	>2000	>2000	T61	MH03	n/a	n/a	n/a	35.2	24.6	n/a	n/a	n/a	35.6
624982.63	4746537.85	O_2236	not_avi	n/a	n/a	n/a	1445.2797	1287.9034	>2000	>2000	>2000	T61	MH03	n/a	n/a	n/a	34	25.3	n/a	n/a	n/a	34.5
624991.37	4746660.17	O_2239	not_avi	n/a	n/a	n/a	1322.9184	1373.7848	>2000	>2000	>2000	T61	MH03	n/a	n/a	n/a	34.7	24.8	n/a	n/a	n/a	35.1
624998.61	4746642.42	O_2243	not_avi	n/a	n/a	n/a	1339.5117	1367.3372	>2000	>2000	>2000	T61	MH03	n/a	n/a	n/a	34.6	24.8	n/a	n/a	n/a	35.0
625004.79	4746493.86	O_2245	not_avi	n/a	n/a	n/a	1486.1513	1278.8139	>2000	>2000	>2000	T61	MH03	n/a	n/a	n/a	33.7	25.2	n/a	n/a	n/a	34.3
625010.25	4746623.9	O_2248	not_avi	n/a	n/a	n/a	1356.3889	1363.9669	>2000	>2000	>2000	T61	MH03	n/a	n/a	n/a	34.5	24.8	n/a	n/a	n/a	34.9
625012.37	4746698.52	O_2249	not_avi	n/a	n/a	n/a	1282.0938	1415.1795	>2000	>2000	>2000	T61	MH03	n/a	n/a	n/a	34.9	24.5	n/a	n/a	n/a	35.3
625018.35	4746545.79	O_2251	not_avi	n/a	n/a	n/a	1433.0192	1320.9119	>2000	>2000	>2000	T61	MH03	n/a	n/a	n/a	34	25	n/a	n/a	n/a	34.5
625030.25	4746551.74	O_2256	not_avi	n/a	n/a	n/a	1425.832	1333.966	>2000	>2000	>2000	T61	MH03	n/a	n/a	n/a	34	24.9	n/a	n/a	n/a	34.5
625036.71	4746664.12	O_2257	not_avi	n/a	n/a	n/a	1313.394	1410.2851	>2000	>2000	>2000	T61	MH03	n/a	n/a	n/a	34.7	24.4	n/a	n/a	n/a	35.1
625041.17	4746506.1	O_2258	not_avi	n/a	n/a	n/a	1470.1881	1315.434	>2000	>2000	>2000	T61	MH03	n/a	n/a	n/a	33.8	24.9	n/a	n/a	n/a	34.3
625046.24	4746644.01	O_2260	not_avi	n/a	n/a	n/a	1332.4217	1404.4094	>2000	>2000	>2000	T61	MH03	n/a	n/a	n/a	34.6	24.4	n/a	n/a	n/a	35.0
625052.08	4746515.69	O_2261	not_avi	n/a	n/a	n/a	1459.6652	1329.8927	>2000	>2000	>2000	T61	MH03	n/a	n/a	n/a	33.8	24.8	n/a	n/a	n/a	34.3
625061.05	4746623.37	O_2263	not_avi	n/a	n/a	n/a	1351.6127	1402.6152	>2000	>2000	>2000	T61	MH03	n/a	n/a	n/a	34.5	24.4	n/a	n/a	n/a	34.9
625071.92	4746522.96	O_2267	not_avi	n/a	n/a	n/a	1450.8503	1350.245	>2000	>2000	>2000	T61	MH03	n/a	n/a	n/a	33.9	24.6	n/a	n/a	n/a	34.4
625072.17	4746596.92	O_2268	not_avi	n/a	n/a	n/a	1377.0759	1394.7902	>2000	>2000	>2000	T61	MH03	n/a	n/a	n/a	34.3	24.4	n/a	n/a	n/a	34.7
625088.04	4746586.33	O_2270	not_avi	n/a	n/a	n/a	1386.5268	1400.8735	>2000	>2000	>2000	T61	MH03	n/a	n/a	n/a	34.2	24.3	n/a	n/a	n/a	34.6
625104.45	4746558.82	O_2274	not_avi	n/a	n/a	n/a	1413.0437	1397.607	>2000	>2000	>2000	T61	MH03	n/a	n/a	n/a	34.1	24.3	n/a	n/a	n/a	34.5
625180.65	4746617.55	O_2282	not_avi	n/a	n/a	n/a	1352.4549	1493.7779	>2000	>2000	>2000	T61	MH03	n/a	n/a	n/a	34.3	23.5	n/a	n/a	n/a	34.6
625202.87	4746612.79	O_2283	not_avi	n/a	n/a	n/a	1357.4565	1509.0161	>2000	>2000	>2000	T61	MH03	n/a	n/a	n/a	34.3	23.4	n/a	n/a	n/a	34.6
625154.88	4746600.34	O_3873	not_avi	n/a	n/a	n/a	1369.8386	1462.817	>2000	>2000	>2000	T61	MH03	n/a	n/a	n/a	34.3	23.8	n/a	n/a	n/a	34.7

625125.91	4746568.59	O_3874	not_avi	n/a	n/a	n/a	1402.341	1420.7176	>2000	>2000	>2000	T61	MH03	n/a	n/a	n/a	34.1	24.1	n/a	n/a	n/a	34.5
621405.29	4747100.96	P_1255	not_avi	n/a	n/a	n/a	693.79611	1395.8	>2000	>2000	>2000	T05	MH02	n/a	n/a	n/a	37	24.5	n/a	n/a	n/a	37.2
621399.48	4747002.98	V_1251	not_avi	n/a	n/a	n/a	785.00583	1358.1888	>2000	>2000	>2000	T05	MH02	n/a	n/a	n/a	36	24.8	n/a	n/a	n/a	36.3
621755.08	4747018.86	V_1308	not_avi	n/a	n/a	n/a	938.92506	1051.991	>2000	>2000	>2000	T05	MH02	n/a	n/a	n/a	35.1	27.8	n/a	n/a	n/a	35.8
621908.2	4746515.67	V_1343	not_avi	n/a	n/a	n/a	1441.1541	734.74063	>2000	>2000	>2000	T05	MH02	n/a	n/a	n/a	32.1	31.4	n/a	n/a	n/a	34.8
622588	4747070	V_1581	not_avi	n/a	n/a	n/a	1380.9376	561.51313	>2000	>2000	>2000	T47	MH05	n/a	n/a	n/a	34.3	35.5	n/a	n/a	n/a	38.0
622822.95	4747628.02	V_1630	not_avi	n/a	n/a	n/a	886.71754	871.85478	>2000	>2000	>2000	T47	MH05	n/a	n/a	n/a	37.3	30	n/a	n/a	n/a	38.0
623377.81	4747182.44	V_1759	not_avi	n/a	n/a	n/a	1484.0734	491.29654	>2000	>2000	>2000	T45	MH05	n/a	n/a	n/a	35.5	36.4	n/a	n/a	n/a	39.0
624852.98	4746529.58	V_2182	not_avi	n/a	n/a	n/a	1476.4141	1183.5493	>2000	>2000	>2000	T61	MH03	n/a	n/a	n/a	34	26.3	n/a	n/a	n/a	34.7
624925.08	4746685.35	V_2207	not_avi	n/a	n/a	n/a	1309.1178	1343.1012	>2000	>2000	>2000	T61	MH03	n/a	n/a	n/a	34.9	25.2	n/a	n/a	n/a	35.3
624981.3	4746600.02	V_2232	not_avi	n/a	n/a	n/a	1383.8872	1326.4452	>2000	>2000	>2000	T61	MH03	n/a	n/a	n/a	34.3	25.1	n/a	n/a	n/a	34.8
624993.21	4746580.51	V_2240	not_avi	n/a	n/a	n/a	1401.5924	1322.9883	>2000	>2000	>2000	T61	MH03	n/a	n/a	n/a	34.2	25	n/a	n/a	n/a	34.7
625043.81	4746580.84	V_2259	not_avi	n/a	n/a	n/a	1395.5304	1362.5562	>2000	>2000	>2000	T61	MH03	n/a	n/a	n/a	34.2	24.7	n/a	n/a	n/a	34.7
625057.37	4746559.35	V_2262	not_avi	n/a	n/a	n/a	1415.7135	1360.1287	>2000	>2000	>2000	T61	MH03	n/a	n/a	n/a	34.1	24.6	n/a	n/a	n/a	34.6
625062.99	4746485.26	V_2264	not_avi	n/a	n/a	n/a	1489.1109	1321.2843	>2000	>2000	>2000	T61	MH03	n/a	n/a	n/a	33.7	24.8	n/a	n/a	n/a	34.2
625118.89	4746521.64	V_2276	not_avi	n/a	n/a	n/a	1449.5253	1387.96	>2000	>2000	>2000	T61	MH03	n/a	n/a	n/a	33.8	24.3	n/a	n/a	n/a	34.3
625153.28	4746546.78	V_2279	not_avi	n/a	n/a	n/a	1423.4177	1430.5401	>2000	>2000	>2000	T61	MH03	n/a	n/a	n/a	33.9	23.9	n/a	n/a	n/a	34.3
625202.89	4746576.21	V_2284	not_avi	n/a	n/a	n/a	1394.0304	1488.1008	>2000	>2000	>2000	T61	MH03	n/a	n/a	n/a	34.1	23.5	n/a	n/a	n/a	34.5
625224.06	4746586.13	V_2287	not_avi	n/a	n/a	n/a	1384.6699	1511.1822	>2000	>2000	>2000	T61	MH03	n/a	n/a	n/a	34.1	23.3	n/a	n/a	n/a	34.4
624943.74	4746584.86	V_3875	not_avi	n/a	n/a	n/a	1404.6434	1288.1235	>2000	>2000	>2000	T61	MH03	n/a	n/a	n/a	34.3	25.4	n/a	n/a	n/a	34.8
624860.8	4746737.66	V_3876	not_avi	n/a	n/a	n/a	1272.2595	1337.062	>2000	>2000	>2000	T61	MH03	n/a	n/a	n/a	35.2	25.5	n/a	n/a	n/a	35.6

not\_avi not available  
n/a no common receptors available for these farms  
NRWC Niagara Region Wind Corporation  
MH Mohawk Wind Farm  
WF Wainfleet Wind Energy  
RF Rosa Flora Turbine  
GREP Grand Renewable Energy Project



## 7.0 Conclusions and Closure

---

This report has been prepared on behalf of FWRN LP. Stantec Consulting Limited (Stantec) was retained by FWRN LP to update the Acoustic Assessment Report to support their proposed amendment to the REA for the Niagara Region Wind Farm. Stantec's assessment of changes indicated that the proposed changes improve the acoustical conditions and therefore considered minor changes. Further, Stantec's conservative assessment predicted that noise emissions during the Project's predictable worst case operation, based on the proposed changes, will continue to meet the MOE criteria at all Points of Reception with the inclusion of noise barriers at both the transformer substations.

The acoustic analysis highlighted in this report is based on information obtained from FWRN LP. The assessment represents the conditions at the Project at the time of the assessment, and the conclusions are the best judgment of the assessor based on current environmental standards and provided information. Stantec attests that to the best of our knowledge, the information presented in this report is accurate.

Respectfully Submitted,

**STANTEC CONSULTING LTD.**



**Kana Ganesh Ph.D., P.Eng.**  
Sr. Acoustics, Noise and Vibration Engineer  
Tel: (905) 415-6332  
Fax: (905) 474-9889  
[Kana.ganesh@stantec.com](mailto:Kana.ganesh@stantec.com)



**(for) Timothy Hung, M. Eng**  
Acoustics and Air Quality Specialist  
Ph: (905) 944-4809  
Fx: (905) 474-9889  
[Timothy.hung@stantec.com](mailto:Timothy.hung@stantec.com)

KG/mcs

\\cd1215-f01\work\_group\01609\active\160950269\planning\noise\2015\11-amendment201509\rpt\_160961052\_aar\_amendment\_2015\_10.docx

## **Appendix A Zoning Maps**

---

Note: Included from September 2014 AAR without edits



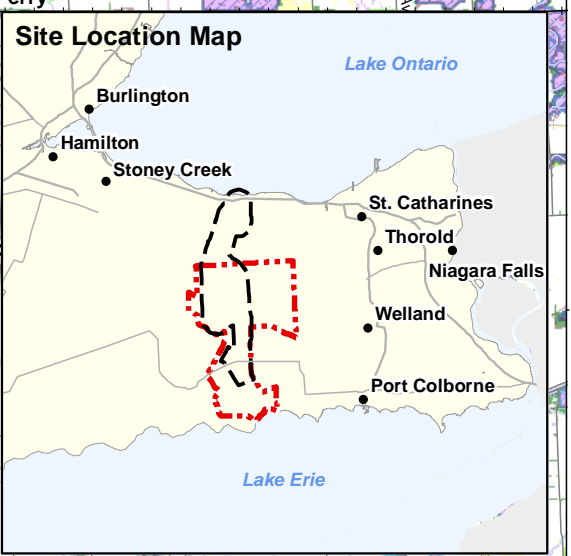
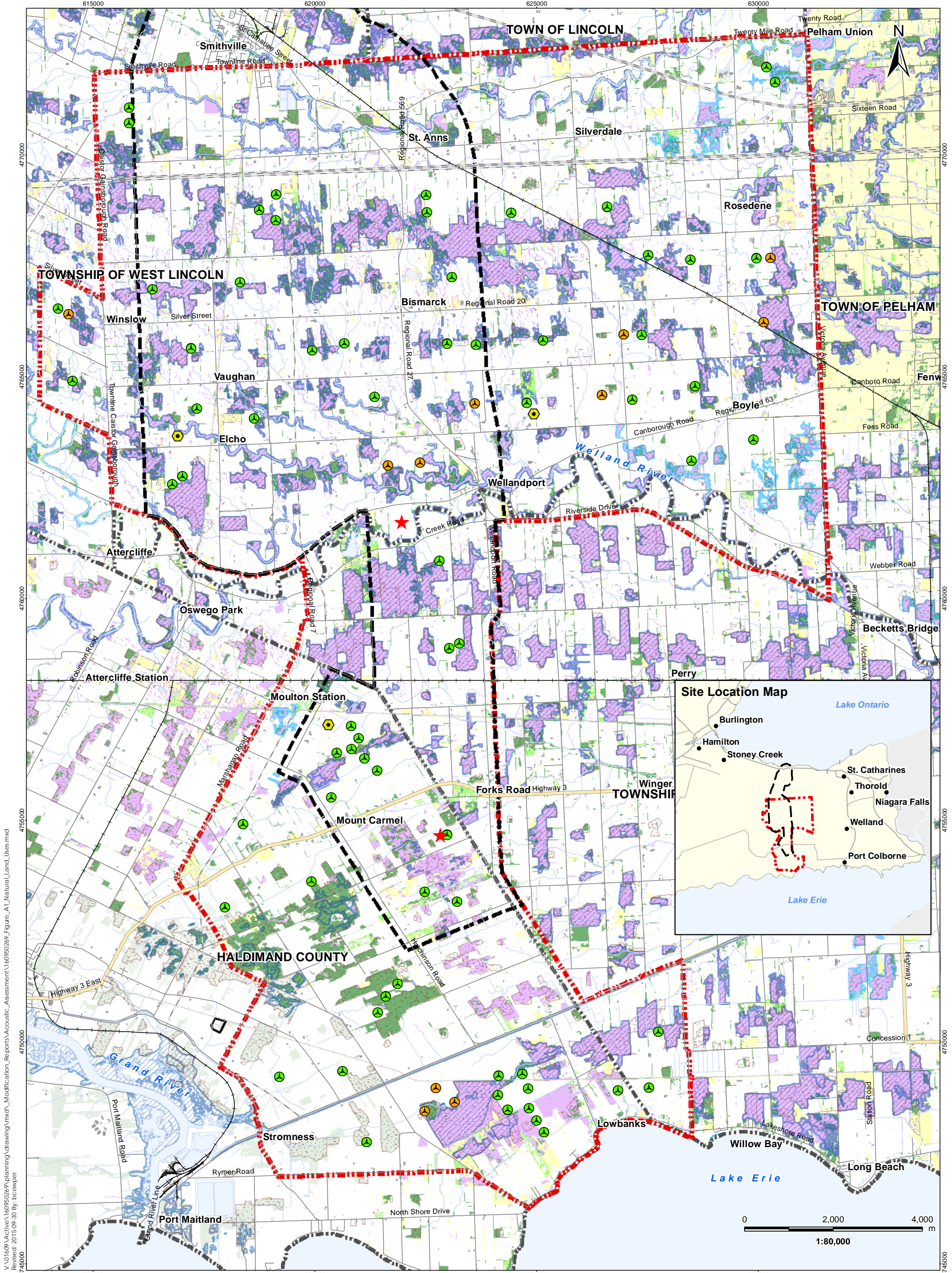

V:\01609\Projects\160950269\planning\drawing\mxd\Modification\_Reports\Acoustic\_Assessment\160950269\_Figure\_A1\_Natural\_Land\_Uses.mxd  
 Revised: 2015-09-30 By: bcompier



**Notes**  
 1. Coordinate System:  
 NAD 1983 UTM Zone 17N  
 2. Base features produced under  
 license with the Ontario  
 Ministry of Natural Resources  
 © Queen's Printer for Ontario, 2012.

Legend	
	Project Study Area
	Interconnector Study Area
	Proposed Turbine Location - E101 3.0 MW
	Proposed Turbine Location - E101 2.9 MW G2/G3
	Transformer Substation
	Tap-in Location
	Existing Met Tower
	Road
	Expressway / Highway
	Active Railway
	Abandoned Railway
	Existing Structures
	Existing Transmission Line
	Watercourse
	Waterbody
	Wooded Area
	Municipality Lower Tier
	Greenbelt
	Deer Wintering Yard (MNR)
	Vegetation Communities
	Open Water
	Open Rock/Shrub Rock Barren
	Shoreline
	Bluff
	Wetlands
	Cultural
	Woodland
	Treed Agriculture

Client/Project  
 FWRN LP  
 Niagara Region Wind Farm  
 Acoustic Assessment Report

Figure No.  
**A1**  
 Title  
**Natural Land Uses**

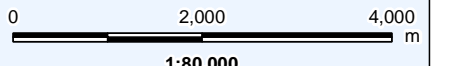

September 2015  
160950269



## Appendix B Project Layout Plan

---

Note: The layout did not change; however the following turbines T18, T36, T45, T46, T47, T53, T55, T60, and T74 have been changed from their previous turbine model and heights as follows:

Turbine ID	September 2014 REA		October 2015 REA Amendment	
	Model	Hub Height	Model	Hub Height
T18	E101	135	E101 2.9 MW G2/G3	124
T33	E101	124	E101 2.9 MW G2/G3	124
T34	E101	124	E101 2.9 MW G2/G3	124
T36	E82	135	E101 2.9 MW G2/G3	124
T45	E101	135	E101 2.9 MW G2/G3	124
T46	E82	135	E101 2.9 MW G2/G3	124
T47	E101	135	E101 2.9 MW G2/G3	124
T53	E82	135	E101 2.9 MW G2/G3	124
T55	E101	135	E101 2.9 MW G2/G3	124
T60	E101	135	E101 2.9 MW G2/G3	124
T74	E101	135	E101 2.9 MW G2/G3	124

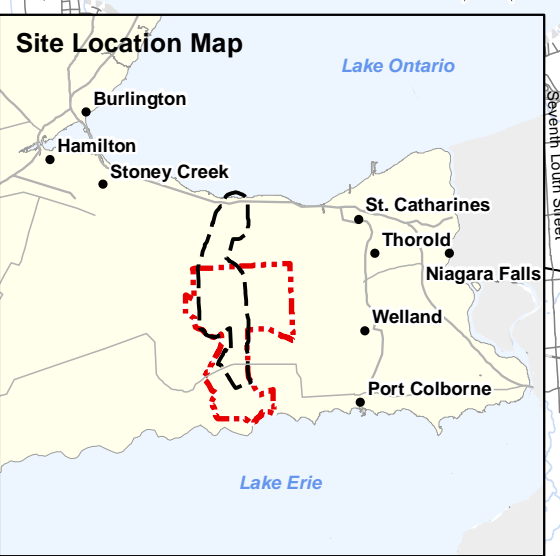
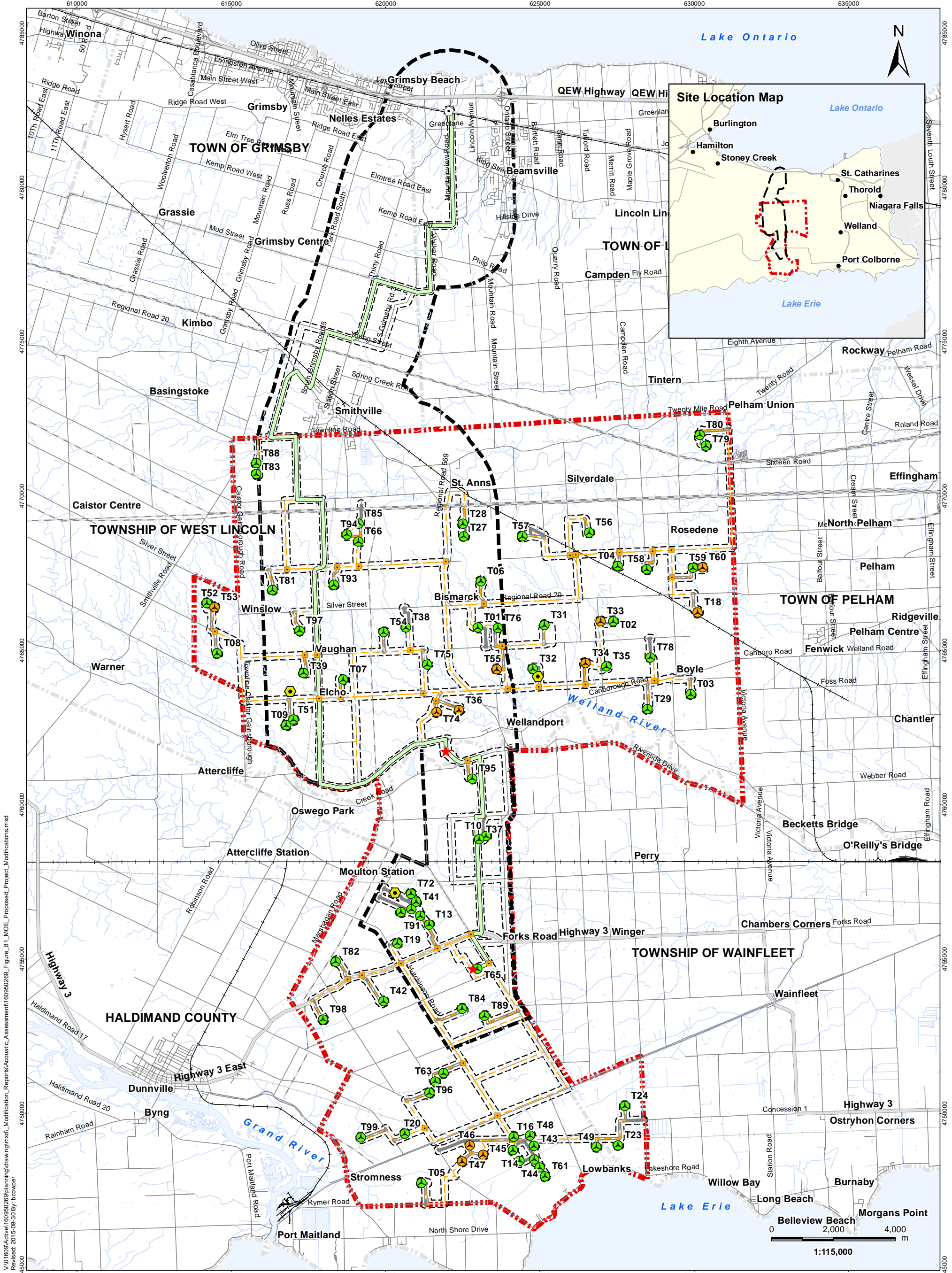

V:\1609\Active\160950268\planning\drawing\mxd\Modification\_Reports\Acoustic\_Assessment\160950268\_Figure\_B1\_MOE\_Proposed\_Project\_Modifications.mxd  
 Revised: 2015-09-30 By: bczwper



**Legend**

	Project Study Area		Preferred Transmission Line Route		Waterbody
	Interconnector Study Area		Alternate Transmission Route		Municipality Lower Tier
	Zone of Investigation		Collector Lines - Underground or Overhead		Road
	Proposed Turbine Location - E101 3.0 MW		Potential Access Road		Expressway / Highway
	Proposed Turbine Location - E101 2.9 MW G2/G3		Active Railway		Abandoned Railway
	Transformer Substation		Existing Transmission Line		Watercourse
	Tap-in Location				
	Existing Met Tower				
	Junction Box				

**Notes**

- Coordinate System: NAD 1983 UTM Zone 17N
- Base features produced under license with the Ontario Ministry of Natural Resources © Queen's Printer for Ontario, 2012.
- T18, T36, T45, T46, T47, T53, T55, T60 and T74 are E101 2.9 MW G2/G3 and all other turbines are E101 3.0 MW.

Client/Project  
 FWRN LP  
 Niagara Region Wind Farm  
 Acoustic Assessment Report

Figure No.  
**B1**

Title  
**Project Component  
 Layout**

September 2015  
 160950269

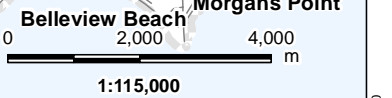

## **Appendix C Results for all Points of Reception (PORs)**

---

Receptor ID	2015 Results (2015 Amend- ment) Sound Level/ Night	2014 Results (2014 REA Sound Level/ Night	UTM Coordinates (NAD 83, Zone 17)		Z [m]	Distance to the nearest Turbine	Nearest Turbine ID
	dBA	dBA	X [m]	Y [m]			
O_1002	39.7	39.7	620717	4766304	187	555	T38
O_1005	35.7	36.2	620722	4763669	185	1080	T75
O_101	35.0	35.0	615006	4771535	195	939	T88
O_1010	38.4	38.4	620728	4766421	188	672	T38
O_1012	35.2	35.2	620733	4752218	185	1460	T62
O_1013	35.5	35.5	620734	4752084	185	1368	T63
O_1016	39.7	39.7	620737	4755005	183	623	T19
O_1017	32.4	33.0	620737	4761846	180	1477	T74
O_102	38.5	38.5	615013	4765305	187	612	T08
O_1029	32.5	33.1	620762	4761877	180	1437	T74
O_103	33.6	33.6	615046	4769911	200	1117	T83
O_1037	38.0	38.1	620776	4766452	188	708	T38
O_105	37.3	37.4	615115	4766832	190	787	T53
O_106	33.5	33.5	615120	4767711	193	1432	T81
O_1063	38.8	38.8	620829	4766361	187	630	T38
O_1069	36.1	36.7	620841	4763620	185	1023	T74
O_1074	39.9	39.9	620855	4755100	183	632	T19
O_1075	37.8	37.8	620855	4766458	188	730	T38
O_108	33.1	33.1	615127	4767820	193	1485	T81
O_1082	35.9	35.9	620868	4752074	185	1265	T62
O_1089	36.3	36.3	620883	4754080	185	1050	T42
O_1093	36.9	36.9	620892	4751828	184	1071	T63
O_1096	39.7	39.8	620899	4750271	180	657	T96
O_1097	40.0	40.0	620899	4764949	185	612	T75
O_1098	38.9	38.9	620900	4754976	184	750	T19
O_1103	37.1	37.2	620911	4751796	184	1034	T63
O_1105	35.8	35.8	620917	4752174	185	1291	T62
O_1107	37.6	37.6	620926	4751706	183	959	T63
O_111	32.8	32.8	615148	4763671	185	1379	T08
O_1112	39.9	39.9	620954	4755166	183	673	T19
O_1116	36.4	37.2	620961	4763553	185	887	T74
O_1127	33.6	34.4	620981	4762035	180	1179	T74
O_113	34.7	34.8	615154	4767422	192	1236	T53
O_114	38.9	38.9	615165	4771059	195	651	T88
O_1142	36.7	37.4	621005	4763632	185	905	T74
O_1148	35.9	35.9	621035	4753811	185	1115	T42
O_115	36.0	36.0	615176	4767123	190	1019	T53
O_1153	39.9	40.0	621067	4749725	181	584	T20
O_1154	38.0	38.0	621068	4751784	183	926	T63
O_1155	37.1	37.8	621069	4763704	185	887	T75
O_1157	37.0	37.7	621072	4763637	185	863	T74
O_116	36.0	36.0	615177	4767127	190	1022	T53
O_1166	33.4	33.9	621121	4761603	176	1498	T74
O_1167	39.5	39.5	621121	4755212	183	801	T19
O_1169	35.8	35.8	621128	4753671	185	1194	T42
O_117	36.5	36.5	615182	4766985	190	931	T53
O_1172	33.5	34.0	621136	4761601	176	1495	T74
O_1173	35.8	35.8	621141	4753705	185	1208	T42
O_1174	38.7	38.7	621143	4755072	185	883	T19
O_1176	37.3	38.0	621145	4763647	185	823	T74
O_1177	34.3	35.0	621149	4762004	183	1120	T74
O_1178	35.8	35.8	621154	4753609	185	1220	T42
O_1179	35.8	35.8	621156	4753679	185	1222	T42
O_118	39.5	39.5	615189	4770950	195	636	T88
O_1180	33.5	34.0	621156	4761598	176	1490	T74
O_1181	39.2	39.2	621156	4755176	184	848	T19
O_1184	39.9	39.9	621175	4751605	183	718	T63
O_1186	33.6	34.1	621177	4761593	176	1488	T74
O_1192	33.7	34.2	621196	4761577	176	1497	T74
O_120	37.1	37.1	615227	4766162	190	808	T53
O_1207	35.8	35.8	621246	4753527	185	1248	T84
O_121	37.1	37.2	615227	4766178	190	804	T53
O_1211	35.8	35.8	621255	4753508	185	1238	T84
O_1212	39.2	39.2	621261	4755230	184	904	T13
O_1215	37.5	37.7	621268	4747099	187	662	T05
O_1216	36.6	36.6	621270	4766434	188	909	T38
O_1221	38.6	38.6	621290	4751870	183	811	T62
O_1222	34.8	35.4	621299	4761833	184	1222	T74
O_1223	36.7	36.7	621299	4766389	188	896	T38
O_1224	35.8	35.8	621300	4753515	185	1193	T84
O_1227	35.9	35.9	621307	4753570	185	1193	T84
O_1228	35.7	35.7	621308	4758305	185	1276	T72
O_123	36.4	36.4	615239	4765575	188	961	T08
O_124	36.4	36.4	615241	4765572	188	959	T08



Receptor ID	2015 Results (2015 Amend- ment) Sound Level/ Night	2014 Results (2014 REA Sound Level/ Night	UTM Coordinates (NAD 83, Zone 17)		Z [m]	Distance to the nearest Turbine	Nearest Turbine ID
	dBA	dBA	X [m]	Y [m]			
O_1247	35.9	35.9	621379	4753207	185	1124	T84
O_125	34.2	34.2	615261	4771884	195	994	T88
O_1250	34.3	34.6	621396	4761324	180	1498	T95
O_1254	34.4	34.8	621405	4761352	180	1498	T95
O_1258	34.4	34.7	621410	4761334	180	1488	T95
O_1259	35.6	36.3	621411	4761957	185	1074	T74
O_126	36.9	36.9	615264	4766146	190	848	T53
O_1260	38.6	38.6	621418	4755178	183	944	T13
O_1262	36.3	36.4	621440	4766383	188	996	T38
O_1263	36.2	36.2	621441	4753401	185	1046	T84
O_1265	32.5	32.6	621491	4770071	190	1416	T28
O_127	36.7	36.7	615272	4766848	190	930	T53
O_1271	37.0	37.2	621537	4747106	188	744	T05
O_1273	35.2	35.2	621549	4768001	193	1213	T27
O_1277	36.6	37.4	621572	4762081	184	925	T74
O_1278	36.7	37.4	621573	4762080	184	926	T74
O_1279	32.7	32.8	621591	4770085	190	1355	T28
O_128	34.5	34.6	615275	4764196	185	1022	T08
O_1282	37.9	38.3	621608	4749173	182	995	T20
O_1284	36.9	36.9	621626	4753241	185	875	T84
O_1286	32.8	32.8	621629	4770089	190	1332	T28
O_1287	33.0	33.0	621630	4770057	190	1308	T28
O_1288	39.2	39.4	621630	4755368	181	786	T13
O_129	36.7	36.7	615276	4766848	190	933	T53
O_1290	39.2	39.2	621653	4757500	182	908	T72
O_1291	36.5	36.5	621659	4752845	185	993	T84
O_1292	35.2	35.4	621671	4761158	180	1186	T95
O_1294	38.4	39.3	621675	4763698	185	695	T74
O_1296	38.7	38.7	621710	4757536	182	975	T72
O_1297	38.8	39.8	621713	4763617	185	617	T74
O_1298	35.5	35.6	621721	4767883	193	1158	T27
O_130	36.4	36.4	615286	4765925	189	958	T53
O_1302	33.8	33.8	621737	4759553	183	1465	T37
O_1305	37.3	37.3	621749	4753817	183	851	T84
O_1306	36.6	36.7	621752	4752614	185	1071	T84
O_1307	38.7	38.9	621752	4755337	181	857	T13
O_131	33.8	33.8	615289	4769760	200	1093	T83
O_1310	38.7	38.7	621760	4757476	181	985	T41
O_1312	34.1	34.2	621768	4769921	186	1114	T28
O_1313	37.3	37.4	621783	4752973	185	820	T84
O_1314	38.6	39.5	621783	4748649	183	728	T47
O_1315	35.3	35.3	621786	4766948	190	1342	T06
O_1316	39.1	39.3	621795	4755456	180	769	T13
O_1317	37.9	37.9	621796	4752162	184	855	T62
O_1319	37.2	37.2	621813	4752867	185	854	T84
O_1320	38.4	38.4	621815	4752085	184	776	T62
O_1321	36.0	36.4	621815	4761193	180	1058	T95
O_1323	38.7	39.7	621824	4763625	184	645	T74
O_1325	35.7	35.9	621827	4761087	185	1018	T95
O_1326	37.2	37.2	621834	4768241	195	842	T27
O_1327	35.8	35.9	621838	4767825	193	1125	T27
O_1328	33.4	33.4	621838	4770101	188	1213	T28
O_1329	38.8	38.9	621839	4764984	185	653	T75
O_1330	35.9	36.0	621845	4766462	189	1347	T01
O_1332	37.7	37.7	621854	4753879	183	798	T84
O_1334	35.4	35.5	621869	4767380	190	1234	T06
O_1335	36.2	36.5	621879	4747111	189	956	T05
O_1336	35.4	35.5	621882	4767096	190	1222	T06
O_1337	39.0	39.2	621893	4755509	180	781	T13
O_1338	38.8	38.9	621894	4769276	190	648	T28
O_1339	38.9	39.6	621895	4747972	185	756	T47
O_134	36.1	36.1	615305	4765626	188	1043	T08
O_1340	38.4	39.2	621895	4763693	184	731	T74
O_1341	37.7	38.6	621897	4762287	180	754	T74
O_1342	35.6	35.8	621901	4746889	190	1132	T05
O_1344	40.0	40.0	621910	4768894	194	640	T28
O_1345	38.3	38.7	621910	4755364	180	908	T13
O_1347	35.7	35.8	621911	4766731	190	1291	T06
O_1348	35.7	35.8	621915	4766703	190	1299	T06
O_1349	39.8	39.8	621921	4768671	195	614	T27
O_135	36.7	36.8	615306	4766195	190	875	T53
O_1350	36.5	36.8	621921	4761187	182	956	T95
O_1351	35.8	35.9	621926	4766627	190	1323	T06
O_1353	36.0	36.1	621932	4766481	190	1285	T01

Receptor ID	2015 Results (2015 Amend- ment) Sound Level/ Night	2014 Results (2014 REA Sound Level/ Night	UTM Coordinates (NAD 83, Zone 17)		Z [m]	Distance to the nearest Turbine	Nearest Turbine ID
	dBA	dBA	X [m]	Y [m]			
O_1355	36.0	36.1	621935	4766509	190	1299	T01
O_1356	37.0	37.0	621935	4769608	187	775	T28
O_1357	36.0	36.1	621939	4766462	190	1269	T01
O_1359	38.9	39.2	621941	4755540	180	787	T13
O_136	36.8	36.9	615320	4766686	190	910	T53
O_1360	35.6	35.8	621954	4746822	189	1217	T05
O_1362	35.4	35.6	621958	4746643	189	1361	T05
O_1363	36.0	36.3	621960	4747048	189	1059	T05
O_1365	35.3	35.5	621967	4746565	189	1430	T05
O_1366	37.6	37.7	621970	4752213	184	907	T62
O_1367	36.1	36.2	621974	4766478	190	1249	T01
O_1368	36.5	36.9	621976	4747236	187	957	T05
O_137	33.2	33.2	615321	4763757	185	1391	T08
O_1370	39.6	39.7	621984	4756847	180	924	T13
O_1372	38.3	38.6	621986	4755401	180	923	T13
O_1373	36.9	37.2	621986	4761210	180	905	T95
O_1376	36.2	36.3	621995	4766401	189	1188	T01
O_1377	38.4	38.4	621998	4752905	185	691	T84
O_1378	36.7	36.7	622001	4767904	194	965	T27
O_1379	37.3	37.4	622002	4752621	184	911	T84
O_138	36.8	36.9	615322	4766688	190	912	T53
O_1380	36.2	36.3	622006	4766429	190	1194	T01
O_1381	37.0	37.2	622006	4761204	181	884	T95
O_1382	37.0	37.2	622006	4761204	181	884	T95
O_1383	36.0	36.0	622012	4766701	190	1212	T06
O_1384	38.5	38.8	622012	4764423	185	666	T75
O_1387	37.1	37.3	622026	4761205	181	866	T95
O_1388	37.1	37.3	622027	4761205	181	866	T95
O_139	36.1	36.1	615325	4765533	187	998	T08
O_1391	34.0	34.0	622040	4770097	190	1109	T28
O_1392	37.2	37.4	622051	4761209	181	845	T95
O_1394	33.6	33.6	622054	4770163	190	1163	T28
O_1396	36.2	36.2	622060	4767512	191	1070	T06
O_1397	33.1	33.2	622060	4770234	190	1226	T28
O_1398	33.0	33.0	622061	4770262	190	1252	T28
O_140	33.6	33.6	615327	4763951	185	1238	T08
O_1402	34.9	34.9	622064	4769972	185	987	T28
O_1404	39.0	39.0	622066	4768266	195	644	T27
O_1408	32.8	32.9	622069	4770287	190	1273	T28
O_1409	39.6	39.6	622070	4768334	195	597	T27
O_141	33.5	33.5	615327	4763885	185	1290	T08
O_1411	32.6	32.6	622075	4770330	190	1311	T28
O_1412	36.4	36.4	622077	4766472	190	1164	T01
O_1415	32.3	32.4	622080	4770375	190	1352	T28
O_1416	32.1	32.1	622080	4770423	190	1397	T28
O_1417	31.6	31.6	622081	4770512	190	1482	T28
O_1418	34.1	34.1	622081	4770099	190	1094	T28
O_1419	37.5	37.5	622081	4752247	184	958	T62
O_142	36.1	36.1	615328	4765537	187	1002	T08
O_1420	32.2	32.2	622083	4770408	190	1383	T28
O_1421	32.2	32.3	622085	4770394	190	1369	T28
O_1422	32.4	32.4	622085	4770362	190	1338	T28
O_1423	31.8	31.8	622085	4770478	190	1448	T28
O_1425	37.9	38.2	622089	4764335	185	760	T75
O_1426	37.8	37.8	622093	4752682	184	813	T84
O_1427	37.4	37.6	622094	4761205	181	805	T95
O_1428	37.4	37.6	622095	4761206	181	805	T95
O_143	36.7	36.7	615329	4766206	190	895	T53
O_1430	37.7	38.1	622097	4764255	183	794	T75
O_1431	36.5	36.6	622098	4766410	190	1109	T01
O_1437	33.7	33.7	622104	4770160	190	1141	T28
O_1438	33.4	33.5	622107	4770201	190	1179	T28
O_144	36.6	36.6	615332	4766147	190	913	T53
O_1440	36.2	36.2	622109	4759138	181	965	T37
O_1441	36.2	36.3	622110	4759110	181	957	T37
O_1444	36.0	36.1	622115	4758040	182	1249	T37
O_1446	32.9	33.0	622117	4770283	190	1252	T28
O_1447	38.3	39.0	622119	4763690	182	679	T36
O_1448	37.8	38.1	622124	4764406	185	779	T75
O_1449	32.5	32.5	622125	4770365	190	1329	T28
O_145	36.1	36.1	615333	4765448	187	954	T08
O_1454	32.7	32.7	622131	4770322	190	1286	T28
O_1456	31.5	31.5	622133	4770544	189	1498	T28
O_1457	36.4	36.4	622134	4758485	182	987	T37

Receptor ID	2015 Results (2015 Amend- ment) Sound Level/ Night	2014 Results (2014 REA Sound Level/ Night	UTM Coordinates (NAD 83, Zone 17)		Z [m]	Distance to the nearest Turbine	Nearest Turbine ID
	dBA	dBA	X [m]	Y [m]			
O_1458	37.6	37.8	622142	4761209	181	764	T95
O_1459	37.6	37.8	622142	4761209	181	763	T95
O_146	36.1	36.1	615334	4765447	187	954	T08
O_1461	38.7	39.3	622147	4749379	182	720	T46
O_1464	36.3	36.3	622153	4759249	181	959	T37
O_1465	37.7	37.8	622154	4761072	185	698	T95
O_1466	38.0	38.4	622157	4755511	180	965	T13
O_1467	37.5	37.5	622157	4752247	184	978	T62
O_1469	37.2	37.2	622162	4757289	180	1244	T41
O_147	36.0	36.1	615336	4765510	187	993	T08
O_1470	38.1	38.5	622163	4755583	180	926	T13
O_1471	37.7	37.9	622165	4761221	181	749	T95
O_1472	31.9	31.9	622178	4770479	190	1424	T28
O_1474	33.6	33.6	622184	4770200	190	1153	T28
O_1476	37.5	37.5	622187	4767902	193	877	T27
O_1477	34.3	34.3	622188	4770096	190	1053	T28
O_1478	37.9	38.0	622189	4761223	181	730	T95
O_1479	37.2	37.2	622195	4767822	193	949	T27
O_148	34.2	34.2	615344	4767601	192	1183	T81
O_1481	36.7	36.7	622198	4766556	190	1130	T01
O_1489	36.5	36.9	622210	4747133	186	1210	T05
O_1491	36.8	36.8	622215	4758503	182	906	T37
O_1492	37.4	38.0	622215	4762190	180	888	T36
O_1494	32.1	32.1	622216	4770446	190	1383	T28
O_1495	36.4	36.4	622217	4757569	180	1415	T41
O_1497	36.5	36.5	622226	4757487	180	1383	T41
O_150	36.1	36.1	615346	4764717	185	825	T08
O_1500	37.9	38.3	622232	4755540	180	1007	T13
O_1501	39.0	39.6	622234	4749400	182	663	T46
O_1502	37.5	37.8	622234	4765030	185	1004	T75
O_1504	37.6	37.7	622251	4752150	183	919	T62
O_1505	33.6	33.6	622251	4770213	190	1148	T28
O_1507	32.3	32.3	622256	4770417	190	1347	T28
O_1508	37.4	37.4	622259	4752371	184	1047	T84
O_1509	31.6	31.6	622264	4770549	186	1475	T28
O_1511	32.5	32.5	622288	4770391	190	1316	T28
O_1513	33.7	33.7	622292	4770204	190	1130	T28
O_1514	38.2	38.2	622294	4755568	180	1043	T13
O_1518	37.1	37.6	622302	4764000	180	940	T36
O_152	36.2	36.3	615347	4765950	189	1000	T53
O_1521	31.5	31.5	622316	4770505	185	1423	T28
O_1524	38.0	38.0	622322	4755719	182	997	T13
O_1525	32.7	32.7	622322	4770361	190	1280	T28
O_1526	37.6	37.6	622329	4752138	183	942	T62
O_1527	38.1	38.1	622334	4755597	181	1063	T13
O_1528	38.9	39.0	622338	4751818	183	686	T62
O_1530	33.9	33.9	622345	4770190	190	1108	T28
O_1532	37.0	37.5	622354	4762128	180	936	T36
O_1533	38.2	38.2	622354	4767938	193	791	T27
O_1534	32.9	32.9	622356	4770337	190	1252	T28
O_1535	32.1	32.1	622361	4770472	190	1385	T28
O_1537	37.8	38.0	622371	4765105	185	887	T01
O_1541	37.1	37.5	622386	4747128	185	1323	T47
O_1542	33.1	33.2	622389	4770304	190	1215	T28
O_1543	32.3	32.3	622395	4770443	190	1352	T28
O_1544	38.0	38.1	622396	4751936	183	812	T62
O_1546	39.6	39.7	622414	4754205	180	741	T65
O_1547	37.0	37.0	622424	4759567	180	921	T37
O_1549	37.2	37.8	622425	4763874	180	812	T36
O_1557	32.5	32.5	622442	4770413	190	1319	T28
O_1558	33.5	33.5	622444	4770259	190	1166	T28
O_1559	38.5	39.0	622454	4749660	181	748	T46
O_1560	37.8	37.9	622463	4766510	190	927	T01
O_1561	38.3	38.9	622470	4763643	180	587	T36
O_1563	37.3	37.3	622476	4759569	180	889	T37
O_1564	32.7	32.7	622479	4770376	190	1281	T28
O_1569	35.6	35.6	622512	4769991	187	895	T28
O_157	34.6	34.6	615366	4767524	192	1124	T81
O_1570	37.6	37.6	622528	4759573	180	860	T37
O_1571	38.8	38.8	622538	4767944	193	764	T27
O_1572	38.9	38.9	622542	4751516	182	696	T62
O_1575	37.1	37.1	622563	4759730	182	973	T37
O_1576	33.9	33.9	622563	4770203	190	1109	T28
O_1577	34.4	34.4	622575	4770141	190	1047	T28

Receptor ID	2015 Results (2015 Amend- ment) Sound Level/ Night	2014 Results (2014 REA Sound Level/ Night	UTM Coordinates (NAD 83, Zone 17)		Z [m]	Distance to the nearest Turbine	Nearest Turbine ID
	dBA	dBA	X [m]	Y [m]			
O_1579	36.2	36.6	622586	4762134	180	952	T36
O_158	36.2	36.2	615379	4764933	185	835	T08
O_1580	36.2	36.6	622587	4762136	180	950	T36
O_1583	38.1	38.4	622589	4747138	185	1313	T47
O_1585	38.8	38.8	622600	4751269	181	724	T62
O_1586	38.6	38.7	622604	4766431	190	785	T01
O_1588	37.8	38.4	622612	4763656	180	637	T36
O_159	33.2	33.2	615392	4763720	185	1461	T08
O_1594	38.3	38.3	622645	4751382	182	771	T62
O_1596	33.8	33.8	622652	4770211	190	1124	T28
O_1597	36.0	36.4	622659	4762102	180	1001	T36
O_160	35.5	35.5	615413	4771821	192	862	T88
O_1600	37.8	37.9	622669	4751522	182	820	T62
O_1602	39.5	39.5	622682	4769629	186	558	T28
O_1603	35.4	35.4	622690	4757622	180	1307	T37
O_1605	38.5	38.8	622699	4765020	185	780	T01
O_1608	36.8	36.8	622714	4755820	184	1172	T65
O_1609	35.7	36.1	622731	4762123	180	1004	T36
O_161	35.9	35.9	615415	4765286	186	947	T08
O_1611	38.1	38.2	622733	4759658	181	835	T37
O_1614	39.1	39.2	622741	4766446	190	742	T01
O_1615	39.4	39.6	622743	4765147	185	645	T01
O_1617	34.2	34.3	622753	4770142	190	1072	T28
O_1619	37.9	38.6	622765	4747540	185	950	T47
O_162	35.9	35.9	615417	4765289	186	950	T08
O_1621	35.5	35.9	622790	4762100	180	1047	T36
O_1623	37.9	38.0	622797	4759731	182	873	T10
O_1624	39.3	39.6	622798	4747175	185	1310	T47
O_1626	37.0	37.7	622801	4763750	183	806	T36
O_1627	38.9	39.4	622805	4749665	181	700	T46
O_1628	36.7	36.7	622815	4755778	185	1112	T65
O_163	32.9	32.9	615444	4763020	185	1417	T09
O_1632	35.5	35.9	622825	4762142	180	1023	T36
O_1633	39.3	39.4	622835	4766529	190	761	T06
O_1634	35.1	35.1	622839	4757583	180	1313	T37
O_1636	39.5	39.5	622845	4766455	190	724	T01
O_1637	33.3	33.3	622846	4770265	190	1215	T28
O_1638	35.6	36.0	622849	4762264	180	927	T36
O_164	36.2	36.3	615444	4766146	189	1021	T53
O_1641	37.0	37.7	622865	4763665	182	774	T36
O_1642	37.9	37.9	622878	4755538	181	865	T65
O_1643	36.3	36.3	622881	4755866	185	1191	T65
O_1645	35.2	35.6	622889	4762111	180	1080	T36
O_1646	37.2	37.4	622895	4761561	180	715	T95
O_1647	36.8	36.9	622898	4751112	181	1040	T62
O_1649	39.6	39.6	622911	4759571	181	678	T10
O_165	36.3	36.4	615446	4766221	190	1006	T53
O_1651	36.7	36.8	622917	4751069	181	1068	T62
O_1656	38.9	39.4	622927	4749678	181	736	T46
O_1657	35.1	35.5	622931	4762118	180	1095	T36
O_1658	36.9	37.6	622936	4763662	183	818	T36
O_166	36.4	36.4	615452	4766237	190	1010	T53
O_1662	39.6	39.7	622948	4766556	190	704	T06
O_1663	37.4	38.0	622949	4763367	181	646	T36
O_1664	37.6	37.7	622953	4761506	180	669	T95
O_1668	39.8	39.8	622961	4755330	180	651	T65
O_167	32.0	32.0	615459	4762118	182	1408	T09
O_1672	36.9	37.7	622974	4763788	184	878	T55
O_1675	33.7	33.8	622982	4770163	190	1164	T28
O_1677	39.5	39.9	622992	4765045	185	700	T01
O_1683	34.8	35.2	623026	4762121	180	1143	T36
O_1685	36.5	36.6	623030	4761609	180	787	T95
O_1686	34.9	35.3	623031	4762240	180	1050	T36
O_1687	36.3	36.5	623038	4750759	180	1286	T62
O_1694	37.9	37.9	623069	4760207	183	692	T95
O_1695	33.5	33.5	623070	4770170	190	1209	T28
O_1696	34.6	34.6	623074	4757512	180	1369	T37
O_1697	36.7	37.3	623074	4763216	181	712	T36
O_17	31.6	31.6	612851	4766482	190	1365	T52
O_170	30.4	30.4	615491	4772493	195	1471	T88
O_1700	34.9	35.3	623091	4762381	180	986	T36
O_1701	34.8	35.3	623093	4762347	180	1011	T36
O_1702	34.6	35.0	623094	4762202	180	1119	T36
O_1704	37.4	37.4	623102	4760082	183	820	T95

Receptor ID	2015 Results (2015 Amend- ment) Sound Level/ Night	2014 Results (2014 REA Sound Level/ Night	UTM Coordinates (NAD 83, Zone 17)		Z [m]	Distance to the nearest Turbine	Nearest Turbine ID
	dBA	dBA	X [m]	Y [m]			
O_1706	37.3	37.4	623105	4760054	183	848	T95
O_1707	39.9	40.0	623108	4766469	190	734	T01
O_1708	36.7	37.5	623109	4763664	184	885	T55
O_171	36.1	36.1	615497	4766131	189	1076	T53
O_1710	38.8	39.1	623113	4747328	185	1284	T47
O_1714	36.1	36.3	623127	4750769	180	1363	T62
O_1715	37.9	37.9	623127	4759827	182	848	T10
O_1717	36.3	36.9	623131	4763168	181	760	T36
O_1719	34.5	34.9	623139	4762209	180	1144	T36
O_172	38.2	38.2	615513	4771618	191	635	T88
O_1720	35.0	35.0	623145	4756031	184	1361	T65
O_1721	34.6	35.0	623146	4762335	180	1058	T36
O_1722	38.3	38.5	623153	4760323	183	626	T95
O_1723	37.8	37.9	623158	4760247	183	693	T95
O_1725	35.5	35.5	623170	4755863	182	1199	T65
O_1726	34.6	35.1	623170	4762410	180	1026	T36
O_1729	34.5	35.0	623179	4762361	180	1065	T36
O_173	36.2	36.3	615525	4766232	190	1082	T53
O_1730	35.8	35.9	623181	4761633	178	863	T95
O_1731	36.0	36.6	623190	4763145	181	815	T36
O_1732	34.4	34.8	623218	4762376	180	1085	T36
O_1733	34.5	34.9	623225	4762440	180	1051	T36
O_1734	39.8	39.9	623228	4766552	190	705	T06
O_1735	36.8	36.8	623234	4755583	180	938	T65
O_1738	34.2	34.5	623258	4762070	180	1297	T95
O_174	34.6	34.6	615549	4767647	192	1045	T81
O_1741	34.3	34.7	623263	4762397	180	1107	T36
O_1742	37.8	39.0	623265	4763874	182	624	T55
O_1743	35.4	36.0	623277	4763043	180	899	T36
O_1744	34.3	34.7	623299	4762480	180	1089	T36
O_1746	39.7	39.7	623319	4759601	180	614	T10
O_1748	34.0	34.5	623330	4762385	180	1168	T36
O_1750	39.7	39.7	623337	4766590	190	697	T06
O_1751	34.2	34.6	623339	4762501	180	1113	T36
O_1754	35.0	35.1	623359	4755842	182	1222	T65
O_1756	34.9	35.5	623361	4762971	180	986	T36
O_1757	33.9	34.3	623372	4762394	180	1198	T36
O_1758	37.5	37.5	623376	4769240	190	872	T28
O_176	36.2	36.2	615569	4766207	189	1085	T81
O_1760	34.5	34.7	623394	4761711	180	1036	T95
O_1761	34.0	34.5	623394	4762532	180	1146	T36
O_1764	34.0	34.4	623420	4762550	180	1161	T36
O_1766	34.9	34.9	623423	4755827	181	1229	T65
O_1767	33.7	34.1	623424	4762357	180	1262	T36
O_1768	33.8	34.2	623424	4762417	180	1229	T36
O_1769	37.1	37.3	623442	4750271	180	1250	T16
O_1770	39.7	39.7	623450	4766472	190	776	T76
O_1772	33.7	34.2	623451	4762445	180	1238	T36
O_1774	33.8	34.3	623464	4762529	180	1210	T36
O_1775	33.7	34.2	623472	4762494	180	1233	T36
O_1776	33.6	34.1	623477	4762429	180	1268	T36
O_1777	38.1	38.3	623480	4750042	180	1044	T16
O_178	30.7	30.7	615577	4772469	195	1430	T88
O_1780	33.6	34.1	623494	4762448	180	1274	T36
O_1781	34.7	34.7	623496	4755818	181	1249	T65
O_1782	39.3	39.4	623497	4766581	190	776	T06
O_1783	37.1	37.1	623498	4755362	182	855	T65
O_1784	33.5	34.0	623500	4762400	180	1303	T36
O_1788	34.0	34.0	623518	4757617	180	1352	T37
O_1789	33.5	34.0	623524	4762474	180	1288	T36
O_1790	33.5	33.9	623525	4762407	180	1321	T36
O_1793	34.7	34.7	623533	4755770	180	1222	T65
O_1794	35.0	35.0	623546	4755699	180	1165	T65
O_1795	33.9	34.0	623546	4757619	180	1360	T37
O_1796	39.9	39.4	623548	4754486	180	596	T65
O_1797	34.7	35.3	623551	4763122	180	1174	T36
O_1798	33.5	33.9	623551	4762474	179	1312	T36
O_18	31.8	31.8	612889	4766208	190	1365	T52
O_180	33.6	33.6	615598	4763331	185	1411	T09
O_1800	38.1	38.3	623553	4750071	180	1023	T16
O_1801	33.4	33.8	623554	4762412	180	1344	T36
O_1802	33.8	34.4	623578	4762756	180	1238	T36
O_1803	33.3	33.8	623581	4762428	178	1359	T36
O_1804	35.0	35.8	623583	4763281	182	1113	T55

Receptor ID	2015 Results (2015 Amend- ment) Sound Level/ Night	2014 Results (2014 REA Sound Level/ Night	UTM Coordinates (NAD 83, Zone 17)		Z [m]	Distance to the nearest Turbine	Nearest Turbine ID
	dBA	dBA	X [m]	Y [m]			
O_1805	34.9	35.6	623585	4763231	181	1163	T55
O_1806	33.4	33.9	623587	4762487	178	1339	T36
O_1807	39.1	39.1	623589	4766583	190	825	T06
O_1808	34.7	35.4	623591	4763160	180	1216	T36
O_1809	33.7	34.2	623598	4762707	180	1271	T36
O_181	34.5	34.5	615610	4769720	199	1017	T83
O_1810	34.5	34.5	623599	4755765	180	1248	T65
O_1812	33.6	34.1	623609	4762668	180	1292	T36
O_1813	33.3	33.7	623609	4762433	176	1383	T36
O_1814	33.3	33.8	623610	4762496	177	1356	T36
O_1815	34.0	34.6	623615	4762914	180	1245	T36
O_1816	34.2	34.8	623617	4762986	180	1241	T36
O_1817	33.3	33.7	623618	4762448	176	1383	T36
O_1818	34.1	34.7	623618	4762957	180	1244	T36
O_1819	34.0	34.6	623620	4762897	180	1253	T36
O_182	36.1	36.1	615625	4771832	190	796	T88
O_1820	33.5	33.8	623629	4761753	180	1214	T95
O_1821	33.9	34.5	623629	4762868	180	1265	T36
O_1822	33.3	33.8	623632	4762503	176	1373	T36
O_1823	38.9	39.0	623634	4766584	190	852	T06
O_1824	33.8	34.4	623636	4762828	180	1279	T36
O_1825	33.6	33.8	623643	4761690	180	1178	T95
O_1826	33.2	33.7	623645	4762459	175	1403	T36
O_1828	33.2	33.7	623659	4762508	175	1395	T36
O_1829	34.9	35.7	623664	4763274	181	1120	T55
O_183	35.5	35.5	615631	4767514	192	898	T81
O_1830	33.2	33.6	623666	4762468	175	1418	T36
O_1831	38.8	38.9	623668	4766583	190	864	T76
O_1832	34.1	34.7	623669	4762989	180	1292	T36
O_1833	33.2	33.7	623669	4762522	175	1400	T36
O_1834	39.2	39.2	623675	4766480	190	762	T76
O_1835	38.1	37.4	623676	4754261	185	809	T65
O_1836	33.1	33.6	623680	4762473	173	1429	T36
O_1837	33.9	34.5	623685	4762938	180	1313	T36
O_1838	33.8	34.4	623686	4762870	180	1322	T36
O_1839	33.6	34.1	623697	4762779	179	1348	T36
O_184	36.1	36.1	615651	4766142	189	1076	T81
O_1841	33.5	34.0	623701	4762744	178	1360	T36
O_1842	33.4	33.9	623708	4762692	178	1380	T36
O_1843	33.4	34.0	623713	4762714	177	1380	T36
O_1844	33.3	33.5	623713	4761702	180	1237	T95
O_185	36.3	36.3	615654	4766231	190	1008	T81
O_1850	39.6	39.6	623775	4758688	180	598	T10
O_1851	37.1	36.6	623786	4754069	185	1008	T65
O_1852	37.1	37.1	623797	4759586	180	803	T10
O_1853	38.4	38.4	623801	4752959	185	618	T89
O_1854	33.4	33.5	623807	4761492	180	1179	T95
O_1857	39.8	39.8	623813	4759096	180	564	T10
O_1858	39.9	39.9	623815	4758978	180	556	T10
O_1859	33.2	33.3	623815	4757620	180	1478	T10
O_1860	38.0	38.0	623816	4759425	180	706	T10
O_1861	32.8	33.1	623817	4761799	180	1378	T95
O_1863	39.5	39.5	623819	4759148	180	581	T10
O_1867	33.4	33.5	623836	4761422	180	1168	T95
O_1869	32.9	33.1	623839	4761688	180	1321	T95
O_187	35.8	35.8	615687	4769862	199	864	T83
O_1870	33.1	33.3	623840	4761565	180	1248	T95
O_1871	32.9	33.2	623840	4761650	180	1299	T95
O_1873	38.2	38.2	623845	4759350	180	687	T10
O_1874	33.0	33.2	623845	4761610	180	1278	T95
O_1875	38.8	38.8	623846	4758712	180	649	T10
O_1878	36.7	36.8	623851	4758357	180	866	T10
O_188	36.1	36.1	615695	4766140	189	1051	T81
O_1880	33.5	33.6	623854	4761324	180	1140	T95
O_1881	39.2	39.2	623856	4758870	180	609	T10
O_1883	35.7	35.7	623863	4758191	180	1001	T10
O_1884	38.9	38.9	623866	4758798	180	636	T10
O_1885	36.6	36.2	623868	4753941	185	1017	T89
O_1889	33.3	33.3	623877	4757697	180	1433	T10
O_189	36.5	36.6	615733	4766292	190	910	T81
O_1896	34.0	34.2	623893	4760488	180	1136	T95
O_1897	32.5	32.8	623894	4761891	180	1497	T95
O_190	33.7	33.7	615737	4772095	190	1039	T88
O_1901	33.9	33.9	623905	4755396	180	1167	T65

Receptor ID	2015 Results (2015 Amend- ment) Sound Level/ Night	2014 Results (2014 REA Sound Level/ Night	UTM Coordinates (NAD 83, Zone 17)		Z [m]	Distance to the nearest Turbine	Nearest Turbine ID
	dBA	dBA	X [m]	Y [m]			
O_1903	34.1	34.1	623905	4755325	180	1125	T65
O_1906	34.9	35.0	623911	4759913	180	1130	T10
O_1908	37.3	37.3	623911	4753005	185	712	T89
O_1911	32.5	32.8	623922	4761722	180	1407	T95
O_1914	32.5	32.7	623932	4761784	180	1454	T95
O_1921	33.5	33.6	623945	4760981	180	1135	T95
O_1925	36.0	35.6	623956	4754005	185	1123	T89
O_1926	33.0	33.2	623963	4761287	180	1227	T95
O_1927	37.9	38.0	623963	4766585	190	924	T76
O_193	36.2	36.2	615753	4766147	189	1010	T81
O_1930	33.7	33.7	623966	4755354	180	1192	T65
O_1931	36.0	35.7	623967	4753937	185	1081	T89
O_1932	33.6	33.6	623967	4755401	180	1220	T65
O_1939	32.3	32.6	623973	4761785	180	1487	T95
O_194	35.5	35.5	615779	4771908	190	850	T88
O_1940	33.4	33.4	623975	4755437	180	1248	T65
O_1941	33.2	33.4	623977	4761052	180	1178	T95
O_1943	35.6	35.7	623981	4759631	180	965	T10
O_1946	36.1	35.8	623984	4753763	185	976	T89
O_1949	38.8	38.9	623990	4750124	180	896	T16
O_195	35.6	35.6	615780	4767618	192	861	T81
O_1952	36.9	37.9	623999	4763714	180	783	T55
O_1954	33.1	33.1	624001	4755513	181	1315	T65
O_1955	35.4	35.4	624001	4754885	180	1038	T65
O_1956	35.1	35.1	624003	4755002	180	1069	T65
O_196	34.7	34.7	615786	4764750	185	1251	T08
O_1961	33.7	33.9	624022	4760171	180	1384	T95
O_1965	35.6	35.0	624027	4754336	184	1098	T65
O_1972	33.5	33.5	624038	4755512	182	1344	T65
O_1973	35.2	35.3	624042	4759641	180	1018	T10
O_1976	35.5	35.0	624046	4754179	185	1174	T65
O_198	35.9	35.9	615832	4767617	191	827	T81
O_1985	37.8	37.9	624069	4766517	190	906	T76
O_1988	34.9	35.0	624090	4759646	180	1058	T10
O_199	36.1	36.1	615881	4767623	191	802	T81
O_1990	37.2	37.2	624096	4767928	190	839	T57
O_1998	32.4	32.6	624133	4761161	180	1352	T95
O_1999	32.2	32.2	624142	4755631	182	1499	T65
O_200	32.7	32.7	615901	4769370	200	1347	T83
O_2001	35.4	35.4	624148	4759377	180	969	T10
O_2006	33.0	33.0	624162	4755501	185	1437	T65
O_2007	33.1	33.1	624167	4755445	185	1409	T65
O_2008	33.0	33.0	624169	4755471	185	1425	T65
O_2009	37.3	37.4	624169	4766612	190	1038	T76
O_201	36.0	36.0	615902	4769876	198	842	T83
O_2010	33.1	33.1	624170	4755419	185	1398	T65
O_2011	33.1	33.1	624171	4755431	185	1405	T65
O_2012	33.2	33.2	624172	4755397	184	1388	T65
O_2013	33.2	33.2	624172	4755382	184	1381	T65
O_2014	33.3	33.3	624173	4755351	184	1366	T65
O_2015	33.2	33.3	624174	4755366	184	1374	T65
O_2016	33.3	33.3	624175	4755337	183	1361	T65
O_2017	33.3	33.3	624176	4755324	183	1355	T65
O_2019	33.4	33.4	624177	4755311	183	1350	T65
O_2020	38.4	38.5	624178	4750209	180	966	T16
O_2021	33.4	33.4	624179	4755296	183	1345	T65
O_2022	33.4	33.4	624180	4755270	182	1334	T65
O_2023	33.4	33.4	624180	4755284	182	1341	T65
O_2024	32.8	32.8	624182	4755527	185	1468	T65
O_2025	32.9	32.9	624184	4755485	185	1446	T65
O_2026	39.5	39.8	624186	4765193	185	759	T76
O_2029	34.3	34.4	624192	4759647	180	1141	T10
O_203	32.4	32.4	615928	4768391	195	1484	T81
O_2031	32.7	32.8	624197	4755529	185	1481	T65
O_2032	32.8	32.9	624198	4755486	185	1458	T65
O_2034	32.7	32.7	624208	4755530	185	1491	T65
O_2035	32.8	32.8	624210	4755486	185	1468	T65
O_2038	32.8	32.8	624221	4755452	185	1459	T65
O_2041	32.8	32.9	624222	4755439	184	1453	T65
O_2042	32.7	32.7	624223	4755485	185	1479	T65
O_2043	32.9	32.9	624223	4755421	184	1445	T65
O_2044	32.9	32.9	624225	4755394	184	1433	T65
O_2045	32.9	32.9	624226	4755406	184	1439	T65
O_2046	33.0	33.0	624233	4755347	184	1417	T65



Receptor ID	2015 Results (2015 Amend- ment) Sound Level/ Night	2014 Results (2014 REA Sound Level/ Night	UTM Coordinates (NAD 83, Zone 17)		Z [m]	Distance to the nearest Turbine	Nearest Turbine ID
	dBA	dBA	X [m]	Y [m]			
O_2048	33.1	33.1	624237	4755304	183	1401	T65
O_2054	37.3	37.5	624254	4766534	190	1020	T76
O_2058	36.9	37.0	624283	4766667	190	1145	T76
O_206	35.4	35.4	615953	4771915	190	867	T88
O_2064	34.4	34.2	624304	4753522	185	1146	T89
O_2066	37.8	38.3	624315	4763811	180	759	T32
O_2069	38.2	38.3	624325	4750251	180	1023	T16
O_2072	33.4	33.5	624333	4759657	180	1264	T10
O_2079	39.2	39.5	624366	4765150	185	848	T32
O_2087	36.8	36.9	624435	4766639	190	1087	T31
O_209	38.4	38.4	615975	4770108	197	626	T83
O_2092	37.4	37.8	624467	4763720	180	758	T32
O_2095	32.5	32.6	624491	4759736	180	1439	T10
O_2096	37.5	37.6	624491	4750356	180	1091	T48
O_2097	35.8	35.8	624497	4769516	186	822	T57
O_2098	36.7	36.9	624500	4766648	190	1052	T31
O_21	30.9	30.9	613063	4764838	184	1483	T08
O_2101	33.0	32.9	624542	4752908	185	1349	T89
O_2105	32.2	32.3	624573	4759676	180	1482	T10
O_2107	36.8	36.9	624577	4766627	190	989	T31
O_211	37.4	37.4	615987	4767532	191	668	T81
O_2112	37.2	37.2	624622	4767976	190	744	T57
O_2116	32.5	32.4	624642	4752747	185	1484	T89
O_2117	32.5	32.4	624646	4752724	185	1494	T89
O_2119	38.8	39.1	624666	4763824	183	597	T32
O_213	36.6	36.6	616000	4766139	189	896	T81
O_2131	37.3	37.4	624697	4766537	190	847	T31
O_2141	36.9	37.0	624718	4766624	190	912	T31
O_215	34.9	34.9	616020	4761979	185	974	T09
O_2153	36.9	37.0	624750	4766629	190	901	T31
O_216	37.6	37.6	616025	4766309	190	731	T81
O_2160	39.8	40.0	624777	4765059	185	649	T32
O_2170	33.3	33.8	624811	4763046	180	1365	T32
O_2172	37.8	37.8	624824	4769191	190	629	T57
O_218	34.8	34.9	616037	4763774	185	1406	T39
O_2183	35.2	35.3	624856	4769473	188	883	T57
O_2187	36.9	37.1	624867	4766633	190	860	T31
O_2191	34.5	34.6	624879	4746506	185	1494	T61
O_22	30.8	30.8	613074	4764761	184	1478	T08
O_220	34.6	34.6	616062	4761880	185	1007	T09
O_2204	32.9	33.4	624917	4762966	180	1451	T32
O_221	35.0	35.0	616072	4769782	198	967	T83
O_2211	36.7	36.8	624929	4766687	190	894	T31
O_2212	35.6	35.7	624935	4746736	185	1258	T61
O_2224	37.5	37.7	624961	4766559	190	762	T31
O_2226	35.3	35.4	624970	4746685	185	1301	T61
O_2231	35.0	35.1	624979	4746622	185	1363	T61
O_2234	35.6	35.7	624982	4746745	185	1240	T61
O_2236	34.6	34.7	624983	4746538	185	1445	T61
O_2237	37.0	37.1	624987	4766643	190	838	T31
O_2239	35.2	35.2	624991	4746660	185	1323	T61
O_224	34.7	34.8	616142	4771934	190	934	T88
O_2243	35.1	35.2	624999	4746642	185	1340	T61
O_2245	34.3	34.4	625005	4746494	185	1486	T61
O_2247	37.0	37.2	625006	4766637	190	829	T31
O_2248	35.0	35.0	625010	4746624	185	1356	T61
O_2249	35.3	35.4	625012	4746699	185	1282	T61
O_2251	34.6	34.7	625018	4746546	185	1433	T61
O_2256	34.6	34.7	625030	4746552	185	1426	T61
O_2257	35.1	35.2	625037	4746664	185	1313	T61
O_2258	34.3	34.4	625041	4746506	183	1470	T61
O_2260	35.0	35.1	625046	4746644	185	1332	T61
O_2261	34.4	34.5	625052	4746516	182	1460	T61
O_2263	34.9	35.0	625061	4746623	185	1352	T61
O_2267	34.4	34.5	625072	4746523	182	1451	T61
O_2268	34.7	34.8	625072	4746597	185	1377	T61
O_227	35.7	35.7	616159	4771824	190	839	T88
O_2270	34.7	34.8	625088	4746586	185	1387	T61
O_2271	37.4	37.4	625090	4768892	190	684	T57
O_2273	35.6	35.7	625099	4767996	190	964	T57
O_2274	34.5	34.6	625104	4746559	183	1413	T61
O_228	35.2	35.2	616162	4761879	185	938	T09
O_2280	39.6	39.9	625153	4765162	185	659	T31
O_2281	37.5	37.7	625166	4766569	190	749	T31

Receptor ID	2015 Results (2015 Amend- ment) Sound Level/ Night	2014 Results (2014 REA Sound Level/ Night	UTM Coordinates (NAD 83, Zone 17)		Z [m]	Distance to the nearest Turbine	Nearest Turbine ID
	dBA	dBA	X [m]	Y [m]			
O_2282	34.7	34.8	625181	4746618	184	1352	T61
O_2283	34.7	34.8	625203	4746613	183	1357	T61
O_2285	34.9	35.0	625216	4746654	185	1316	T61
O_2286	34.7	34.8	625221	4746627	184	1344	T61
O_2289	36.8	37.0	625233	4766666	190	849	T31
O_229	36.0	36.0	616174	4769943	197	849	T83
O_2290	34.7	34.8	625236	4746625	183	1346	T61
O_2292	34.7	34.8	625245	4746632	183	1340	T61
O_2295	34.7	34.8	625259	4746638	183	1335	T61
O_2297	39.4	39.6	625277	4765161	185	672	T31
O_230	34.9	34.9	616175	4769802	198	979	T83
O_2301	35.7	35.7	625310	4750478	180	1348	T48
O_2304	35.8	35.9	625344	4746847	185	1135	T61
O_2306	35.5	35.6	625364	4768244	190	1033	T57
O_2310	35.6	35.6	625384	4746817	183	1171	T61
O_2311	36.2	36.2	625407	4746921	183	1074	T61
O_2312	36.5	36.5	625412	4750263	180	1220	T48
O_2313	36.4	36.5	625413	4746964	182	1033	T61
O_2315	36.5	36.5	625435	4746977	181	1026	T61
O_2316	35.9	36.0	625437	4750373	180	1323	T48
O_2318	36.8	36.8	625445	4747020	181	987	T61
O_2320	35.0	35.0	625454	4769146	190	1114	T57
O_2322	36.8	36.9	625461	4750173	180	1180	T48
O_2324	36.8	36.9	625478	4747042	181	975	T61
O_2325	37.6	37.7	625479	4747151	183	872	T61
O_2326	39.2	39.5	625479	4765253	187	656	T31
O_2327	37.7	37.8	625499	4749969	180	1063	T48
O_2330	37.1	37.2	625512	4747098	181	934	T61
O_2332	36.8	36.9	625542	4750126	180	1201	T48
O_2333	37.2	37.2	625546	4747118	181	929	T61
O_2337	37.2	37.3	625570	4747137	181	921	T61
O_2338	37.1	37.2	625577	4750033	180	1165	T48
O_2341	37.3	37.3	625590	4747158	181	911	T61
O_2344	37.1	37.2	625621	4747149	181	933	T61
O_2346	38.3	38.4	625643	4749718	180	1051	T48
O_2349	37.5	37.5	625669	4749900	180	1160	T48
O_2350	38.6	38.6	625700	4749604	180	1063	T48
O_2351	35.9	36.5	625705	4763815	182	1100	T32
O_2354	38.9	38.9	625733	4747483	185	739	T61
O_2355	39.0	39.0	625735	4749464	180	1053	T43
O_2357	38.9	38.9	625755	4747505	185	742	T61
O_236	35.4	35.4	616227	4764771	185	1225	T39
O_2362	39.1	39.1	625772	4749396	180	1055	T43
O_2365	38.2	38.3	625776	4747425	185	810	T61
O_2366	37.3	37.3	625778	4747273	185	920	T61
O_2367	39.1	39.1	625783	4749372	180	1055	T43
O_2368	36.3	36.7	625788	4766608	190	1013	T31
O_2369	37.3	37.4	625793	4747293	185	915	T61
O_237	39.6	39.6	616230	4762769	185	592	T09
O_2370	39.2	39.2	625796	4749342	180	1055	T43
O_2373	38.2	38.3	625800	4747446	185	814	T61
O_2374	37.8	38.7	625805	4764309	185	738	T34
O_2376	38.9	38.9	625814	4747573	185	751	T61
O_2377	38.2	38.2	625823	4747460	185	823	T61
O_2378	37.2	37.2	625824	4747298	184	933	T61
O_238	38.0	38.0	616240	4766268	189	706	T81
O_2381	36.9	37.7	625831	4764047	183	852	T34
O_2382	37.2	37.2	625836	4747309	184	933	T61
O_2383	39.3	39.3	625838	4749261	180	1056	T49
O_2384	33.3	33.3	625845	4769726	188	1175	T56
O_2385	33.7	33.7	625845	4769647	188	1116	T56
O_2386	38.8	38.8	625845	4747585	185	771	T61
O_2387	38.7	38.7	625846	4749441	180	1121	T49
O_2388	39.4	39.4	625846	4749209	180	1032	T49
O_2389	37.2	37.2	625848	4747318	183	935	T61
O_239	35.5	35.5	616242	4764924	185	1209	T97
O_2390	33.9	34.0	625849	4769603	188	1081	T56
O_2392	35.3	35.3	625859	4769346	190	905	T56
O_2393	38.2	38.2	625859	4747503	185	827	T61
O_2394	38.7	38.8	625861	4747604	185	775	T61
O_2400	38.2	38.3	625873	4747523	185	827	T61
O_2401	36.0	36.4	625878	4766685	190	1130	T31
O_2405	38.9	38.9	625888	4749340	180	1039	T49
O_2406	37.2	37.3	625893	4747366	184	937	T61

Receptor ID	2015 Results (2015 Amend- ment) Sound Level/ Night	2014 Results (2014 REA Sound Level/ Night	UTM Coordinates (NAD 83, Zone 17)		Z [m]	Distance to the nearest Turbine	Nearest Turbine ID
	dBA	dBA	X [m]	Y [m]			
O_2407	38.8	39.9	625894	4764712	185	605	T34
O_2408	36.9	37.8	625899	4764035	183	809	T34
O_2409	38.1	38.2	625900	4747540	185	842	T61
O_2415	38.0	38.1	625916	4747540	185	855	T61
O_2416	37.4	37.4	625918	4747416	185	926	T61
O_2417	33.6	33.7	625925	4769697	187	1102	T56
O_2418	38.2	38.8	625932	4765367	188	905	T31
O_2419	36.4	36.5	625935	4768297	190	848	T56
O_2420	39.7	39.8	625936	4748931	180	900	T49
O_2421	39.1	39.1	625937	4749236	180	954	T49
O_2423	34.1	34.1	625941	4769625	188	1035	T56
O_2424	36.5	36.6	625948	4769204	190	753	T56
O_2431	37.2	37.2	625972	4747436	184	958	T61
O_2434	39.7	39.8	625982	4748851	180	856	T49
O_2436	37.2	37.2	625989	4747446	183	966	T61
O_2439	37.1	37.2	626003	4747453	183	975	T61
O_2440	39.6	39.6	626011	4748970	180	827	T49
O_2441	39.7	39.8	626012	4748793	180	833	T49
O_2443	37.1	37.1	626025	4747464	183	988	T61
O_2446	37.0	37.0	626047	4747475	183	1001	T61
O_2449	39.7	39.7	626063	4748714	180	799	T49
O_245	35.1	35.1	616304	4769881	198	964	T83
O_2450	37.0	37.0	626063	4747489	183	1008	T61
O_2453	37.0	37.1	626079	4747520	184	1008	T61
O_2454	36.1	36.2	626091	4768045	190	931	T56
O_2460	33.8	34.4	626118	4763293	180	1349	T34
O_2462	35.5	35.7	626127	4767789	190	1138	T56
O_2465	38.9	38.9	626141	4749284	180	787	T49
O_2468	38.3	38.4	626147	4769196	190	585	T56
O_2469	35.2	35.5	626150	4767552	190	1350	T56
O_247	37.3	37.3	616326	4767649	190	683	T81
O_2471	36.4	37.0	626162	4766627	190	1053	T33
O_2472	36.6	36.6	626163	4747516	180	1086	T61
O_2474	36.6	36.6	626175	4747529	180	1091	T61
O_2475	36.9	36.9	626176	4747597	181	1067	T61
O_2477	36.9	36.9	626202	4747638	181	1077	T61
O_2478	36.6	36.6	626203	4747555	180	1107	T61
O_2479	36.9	37.0	626204	4768136	190	794	T56
O_248	37.5	37.6	616326	4763327	185	883	T09
O_2483	36.6	36.7	626215	4768059	190	857	T56
O_2484	38.9	38.9	626227	4748303	180	863	T49
O_2485	37.7	37.7	626228	4747899	181	1054	T61
O_2486	36.5	37.1	626244	4766648	190	1006	T33
O_2487	37.5	37.6	626246	4747868	180	1074	T61
O_2489	37.6	37.7	626253	4747906	181	1078	T61
O_2490	37.4	37.4	626257	4747839	180	1088	T61
O_2491	35.6	35.8	626258	4767611	190	1261	T56
O_2492	37.3	37.4	626259	4747823	180	1092	T61
O_2493	37.2	37.3	626261	4747803	180	1097	T61
O_2496	37.7	37.7	626265	4747946	180	1088	T61
O_2497	35.5	35.7	626266	4767468	190	1288	T04
O_2498	37.1	37.2	626267	4747779	180	1107	T61
O_2499	37.9	37.9	626270	4748015	180	1063	T49
O_25	33.3	33.3	613095	4766267	190	1150	T52
O_250	34.1	34.1	616332	4769729	199	1110	T83
O_2500	38.5	38.6	626279	4748214	180	895	T49
O_2502	35.8	36.3	626281	4766978	190	1236	T33
O_2504	37.7	37.7	626294	4747974	180	1086	T49
O_2506	35.7	36.2	626298	4767029	190	1270	T33
O_2507	37.2	37.3	626299	4747846	180	1129	T61
O_2509	37.8	37.8	626303	4748007	180	1053	T49
O_251	38.3	38.3	616354	4766279	189	688	T81
O_2510	37.2	37.2	626304	4747829	180	1136	T61
O_2511	37.3	37.4	626305	4747876	180	1131	T61
O_2512	37.1	37.1	626311	4747811	180	1145	T61
O_2513	37.0	37.0	626312	4747791	180	1150	T61
O_2514	37.9	37.9	626320	4748042	180	1014	T49
O_2515	36.9	36.9	626325	4747766	180	1166	T61
O_2516	37.9	38.0	626330	4748071	180	984	T49
O_2517	36.8	36.8	626334	4747749	180	1178	T61
O_2518	36.7	36.8	626337	4747737	180	1183	T61
O_2519	38.8	38.8	626337	4748288	180	801	T49
O_2520	36.7	36.7	626342	4747723	180	1190	T61

Receptor ID	2015 Results (2015 Amend- ment) Sound Level/ Night	2014 Results (2014 REA Sound Level/ Night	UTM Coordinates (NAD 83, Zone 17)		Z [m]	Distance to the nearest Turbine	Nearest Turbine ID
	dBA	dBA	X [m]	Y [m]			
O_2521	36.6	36.6	626343	4747701	180	1197	T61
O_2522	38.9	40.0	626354	4765297	185	718	T34
O_2523	34.6	35.3	626361	4763416	184	1182	T34
O_2524	36.6	37.3	626362	4766706	190	970	T33
O_2526	39.2	39.3	626380	4749394	180	662	T49
O_2528	37.9	37.9	626398	4748093	180	931	T49
O_2530	37.1	37.8	626421	4766621	190	866	T33
O_2531	37.9	37.9	626423	4748105	180	909	T49
O_2532	38.0	38.0	626463	4748127	180	872	T49
O_2533	38.2	38.2	626466	4748167	180	835	T49
O_2534	39.3	39.3	626476	4749447	180	642	T49
O_2535	38.1	38.1	626501	4748157	180	828	T49
O_2538	37.1	37.8	626522	4766716	190	887	T33
O_2539	38.2	38.2	626524	4748172	180	806	T49
O_2542	38.3	38.3	626556	4748183	180	783	T49
O_2545	38.5	38.5	626575	4748212	180	750	T49
O_2546	38.0	38.1	626575	4768084	190	741	T56
O_2547	33.3	33.4	626585	4750955	180	1370	T24
O_2549	38.9	38.9	626643	4748260	180	683	T49
O_2550	39.8	40.9	626675	4748246	180	688	T49
O_2552	38.8	38.8	626678	4768086	190	743	T56
O_2553	38.2	38.3	626679	4763944	185	675	T34
O_2554	38.9	39.7	626713	4748274	180	653	T49
O_2556	39.1	39.1	626722	4763508	181	1070	T35
O_2557	35.7	36.3	626729	4768070	190	766	T56
O_2558	38.3	38.4	626766	4766655	190	734	T33
O_2562	38.2	39.1	626804	4748276	180	640	T49
O_2564	39.2	39.2	626860	4748277	180	639	T49
O_2566	39.2	39.2	626872	4750965	180	1141	T24
O_2568	33.9	33.9	616387	4767550	190	585	T81
O_257	38.5	38.5	626887	4768182	190	704	T56
O_2570	39.1	39.1	626893	4748300	180	618	T49
O_2571	39.5	39.5	626896	4751391	181	1435	T24
O_2573	32.1	32.1	626902	4768082	190	710	T04
O_2574	38.9	39.0	626912	4766743	190	795	T33
O_2575	38.2	38.9	626914	4766676	190	728	T33
O_2576	38.6	39.4	626937	4763480	180	1028	T35
O_2578	35.8	36.3	616391	4764975	185	1060	T97
O_258	36.1	36.1	626955	4748315	180	611	T49
O_2580	39.6	39.6	626964	4768205	190	720	T56
O_2582	39.2	39.3	626977	4748260	180	670	T49
O_2583	39.0	39.0	626986	4766755	190	805	T33
O_2585	38.3	39.0	626999	4748265	180	670	T49
O_2588	39.0	39.1	627000	4748324	180	613	T49
O_2589	39.7	39.7	627019	4748271	180	670	T49
O_2591	39.1	39.1	627022	4748337	180	608	T49
O_2593	39.8	39.8	627035	4766753	190	806	T33
O_2595	38.5	39.1	627037	4748277	180	669	T49
O_2596	39.1	39.1	627060	4763919	185	573	T35
O_2598	39.6	40.0	627064	4748280	180	674	T49
O_2599	39.1	39.1	627077	4748338	180	626	T49
O_2601	39.7	39.7	627085	4766744	190	802	T33
O_2603	38.6	39.2	627086	4748281	180	681	T49
O_2604	39.1	39.1	627100	4748337	180	635	T49
O_2605	39.7	39.7	627103	4748278	180	691	T49
O_2606	39.0	39.1	627123	4748276	180	700	T49
O_2607	39.0	39.0	627130	4748341	180	645	T49
O_2608	39.7	39.7	627136	4748281	180	702	T49
O_2609	39.0	39.0	616418	4766122	189	848	T81
O_261	37.6	37.6	627154	4748279	180	711	T49
O_2610	39.0	39.0	627155	4748349	180	650	T49
O_2611	39.7	39.7	627171	4748274	180	723	T49
O_2613	38.9	38.9	627186	4748353	180	662	T49
O_2616	39.7	39.7	627189	4748272	180	734	T49
O_2617	38.9	38.9	627202	4748276	180	737	T49
O_2618	38.9	38.9	627215	4748356	180	676	T49
O_2619	39.7	39.7	616437	4770047	198	908	T83
O_262	35.6	35.6	627224	4748276	180	747	T49
O_2620	38.9	38.9	627245	4748288	180	747	T23
O_2623	38.9	39.0	627263	4748288	180	740	T23
O_2624	38.9	38.9	627280	4748361	180	666	T23
O_2627	39.6	39.6	627281	4748294	180	728	T23
O_2628	39.0	39.0	627288	4767199	190	590	T04
O_2629	39.6	39.8	627299	4748292	180	723	T23

Receptor ID	2015 Results (2015 Amend- ment) Sound Level/ Night	2014 Results (2014 REA Sound Level/ Night	UTM Coordinates (NAD 83, Zone 17)		Z [m]	Distance to the nearest Turbine	Nearest Turbine ID
	dBA	dBA	X [m]	Y [m]			
O_2632	38.9	38.9	627310	4748364	180	652	T23
O_2633	39.6	39.6	627323	4748286	180	721	T23
O_2634	38.8	38.8	627350	4748253	180	745	T23
O_2637	38.5	38.5	627376	4763706	182	805	T35
O_2639	37.5	37.8	616451	4771878	191	1036	T88
O_264	34.0	34.0	627384	4763616	181	895	T35
O_2643	36.9	37.2	627392	4748246	180	743	T23
O_2644	38.3	38.3	627404	4762100	184	1482	T29
O_2645	31.4	31.7	627410	4748249	180	736	T23
O_2646	38.3	38.3	627413	4751359	180	1171	T24
O_2647	32.9	32.9	627423	4769441	190	1029	T56
O_2649	34.4	34.4	616456	4764645	185	965	T39
O_265	36.3	36.4	627427	4748278	180	706	T23
O_2650	38.6	38.6	627435	4748323	180	659	T23
O_2651	39.0	39.0	627442	4769615	190	1155	T56
O_2652	33.4	33.5	627446	4748276	180	704	T23
O_2653	38.5	38.5	627479	4748272	180	705	T23
O_2656	38.4	38.4	627487	4748373	180	603	T23
O_2658	39.5	39.5	627496	4769279	190	1005	T56
O_2659	34.8	34.9	616460	4771937	192	1089	T88
O_266	33.5	33.5	627500	4751408	180	1196	T24
O_2660	32.6	32.7	627519	4748261	180	713	T23
O_2662	38.2	38.2	627527	4768886	190	930	T56
O_2664	36.3	36.4	627531	4748309	180	666	T23
O_2665	38.6	38.7	627535	4748264	180	710	T23
O_2666	38.2	38.2	627547	4748255	180	719	T23
O_2667	38.0	38.1	627562	4748256	180	719	T23
O_2668	38.0	38.0	616466	4761785	184	855	T09
O_267	36.1	36.1	627568	4748325	180	650	T23
O_2671	38.7	38.7	627577	4748254	180	721	T23
O_2673	38.0	38.0	627580	4769711	190	1322	T56
O_2674	32.6	32.7	627588	4764000	185	643	T35
O_2676	39.0	39.3	627600	4748248	180	728	T23
O_2677	37.8	37.8	627617	4748335	180	644	T23
O_2679	38.7	38.7	616479	4766186	189	793	T81
O_268	38.0	38.0	627626	4768833	190	1027	T56
O_2680	36.2	36.3	627652	4748215	180	768	T23
O_2682	37.3	37.4	627656	4748237	180	746	T23
O_2683	37.5	37.5	627670	4748230	180	755	T23
O_2686	37.4	37.4	627677	4768331	190	611	T04
O_2687	39.2	39.3	627685	4766692	190	810	T02
O_2688	38.7	39.1	627686	4748225	180	763	T23
O_2689	37.3	37.3	627693	4764983	189	728	T35
O_2690	39.7	40.0	627701	4751505	180	1267	T24
O_2691	32.1	32.1	627717	4748220	180	775	T23
O_2692	37.2	37.2	627752	4748260	180	745	T23
O_2693	37.4	37.4	627754	4748204	180	799	T23
O_2694	36.9	36.9	627769	4748199	180	809	T23
O_2695	36.8	36.8	627782	4762826	178	767	T29
O_2696	36.4	36.5	627788	4748190	180	822	T23
O_2697	36.6	36.6	627798	4748260	181	759	T23
O_2698	37.2	37.2	627802	4764005	185	797	T35
O_2699	38.3	38.5	613114	4764680	183	1449	T08
O_27	30.9	30.9	616496	4764832	185	1017	T39
O_270	36.5	36.5	627802	4748187	181	830	T23
O_2700	36.5	36.5	627831	4748175	181	850	T23
O_2701	36.3	36.3	627839	4748259	182	776	T23
O_2702	36.9	37.0	627855	4768947	190	1252	T04
O_2703	35.0	35.1	627859	4748181	182	855	T23
O_2704	36.2	36.2	627881	4762747	180	711	T29
O_2706	36.8	36.9	627882	4748165	183	878	T23
O_2707	36.0	36.0	627896	4762700	180	723	T29
O_2708	36.7	36.8	627898	4761841	182	1395	T29
O_2709	31.3	31.5	627899	4765540	190	657	T02
O_2710	39.6	40.0	627901	4748225	184	832	T23
O_2711	36.4	36.4	627904	4748163	185	890	T23
O_2712	35.9	35.9	627915	4766778	190	993	T02
O_2713	38.2	38.5	627930	4748148	184	914	T23
O_2715	35.7	35.7	627931	4751602	180	1374	T24
O_2716	31.4	31.4	627939	4751567	180	1341	T24
O_2717	31.6	31.6	627945	4748147	185	921	T23
O_2718	35.6	35.6	616524	4761770	179	849	T09
O_272	36.2	36.2	627959	4748275	184	815	T23
O_2720	36.4	36.4	627967	4762691	180	671	T29

Receptor ID	2015 Results (2015 Amend- ment) Sound Level/ Night	2014 Results (2014 REA Sound Level/ Night	UTM Coordinates (NAD 83, Zone 17)		Z [m]	Distance to the nearest Turbine	Nearest Turbine ID
	dBA	dBA	X [m]	Y [m]			
O_2721	37.2	37.3	627972	4748139	185	940	T23
O_2722	35.4	35.4	627974	4764010	185	938	T35
O_2723	38.1	38.3	627976	4763835	185	902	T29
O_2724	37.8	38.0	627990	4748126	184	960	T23
O_2726	35.2	35.2	627995	4748199	185	899	T23
O_2728	35.7	35.7	616527	4763296	185	735	T51
O_273	39.0	39.0	628003	4748120	184	972	T23
O_2730	35.1	35.1	628016	4748118	184	980	T23
O_2731	35.1	35.1	628021	4762645	180	659	T29
O_2733	37.3	37.4	628031	4748109	182	995	T23
O_2734	34.9	34.9	628043	4748196	185	927	T23
O_2735	35.4	35.4	628057	4748105	183	1011	T23
O_2737	34.8	34.8	628077	4748089	184	1035	T23
O_2740	34.6	34.6	628087	4748145	185	994	T23
O_2741	34.9	34.9	628095	4762136	180	1046	T29
O_2742	33.5	33.6	628110	4761706	185	1447	T29
O_2743	30.9	31.1	628148	4748066	183	1093	T23
O_2745	34.1	34.2	628171	4748057	181	1114	T23
O_2748	34.0	34.0	616533	4769817	199	1146	T83
O_275	34.0	34.0	628196	4748045	181	1138	T23
O_2751	33.8	33.8	628200	4748127	184	1074	T23
O_2752	34.2	34.2	628208	4768177	190	609	T58
O_2753	39.7	39.8	628217	4748032	180	1160	T23
O_2755	33.6	33.7	628232	4765412	190	720	T78
O_2757	38.8	39.1	628232	4750703	180	667	T24
O_2758	37.1	37.1	628244	4748025	180	1182	T23
O_2761	33.5	33.5	628255	4751154	180	1044	T24
O_2764	33.4	33.4	628260	4748018	180	1198	T23
O_2765	33.4	33.4	628271	4763928	185	858	T29
O_2769	38.2	38.3	628278	4748019	180	1208	T23
O_2772	33.3	33.3	628289	4748004	180	1226	T23
O_2776	33.2	33.2	616539	4763431	185	833	T51
O_278	38.2	38.2	628302	4747997	180	1240	T23
O_2781	33.1	33.1	628309	4750020	180	599	T24
O_2784	38.4	38.4	628319	4747991	180	1255	T23
O_2785	33.0	33.0	616567	4763277	185	694	T51
O_279	39.4	39.4	628333	4747985	180	1268	T23
O_2794	32.9	32.9	613117	4766344	190	1114	T52
O_28	33.5	33.5	616570	4753077	181	1413	T98
O_280	30.8	30.8	628344	4761639	175	1469	T29
O_2804	30.5	30.7	628346	4747996	180	1268	T23
O_2806	32.9	32.9	616618	4763368	185	736	T51
O_281	39.0	39.0	616629	4767594	190	690	T81
O_282	37.4	37.4	628390	4747969	180	1317	T23
O_2822	32.6	32.6	628406	4747962	180	1332	T23
O_2824	32.5	32.5	628430	4747943	180	1362	T23
O_2828	32.3	32.4	628440	4747943	180	1369	T23
O_2829	32.3	32.3	628445	4749553	180	975	T24
O_2832	36.0	36.0	628455	4748023	184	1320	T23
O_2834	32.6	32.6	628455	4747937	180	1384	T23
O_2835	32.2	32.2	628473	4747938	181	1394	T23
O_2837	32.2	32.2	628501	4748126	185	1282	T23
O_2838	32.7	32.8	616648	4753130	180	1337	T98
O_284	31.2	31.2	628502	4748109	185	1294	T23
O_2840	32.7	32.7	628502	4748077	185	1316	T23
O_2841	32.6	32.6	628504	4748144	185	1273	T23
O_2842	32.8	32.8	628504	4748091	185	1308	T23
O_2843	32.6	32.6	628510	4748056	185	1336	T23
O_2844	32.4	32.5	628513	4747894	181	1454	T23
O_2845	31.8	31.9	628514	4748154	185	1273	T23
O_2846	32.8	32.8	628516	4748041	185	1351	T23
O_2847	32.4	32.4	628519	4764037	185	748	T78
O_2849	38.6	38.7	616650	4771887	194	1175	T88
O_285	32.9	32.9	628522	4748090	185	1322	T23
O_2851	32.5	32.5	628523	4748104	185	1313	T23
O_2852	32.6	32.6	628526	4748119	185	1306	T23
O_2853	32.6	32.6	628526	4748075	185	1335	T23
O_2854	32.4	32.5	628527	4748161	185	1280	T23
O_2856	32.8	32.8	628529	4748037	185	1363	T23
O_2857	32.3	32.3	628531	4748138	185	1296	T23
O_2858	32.7	32.7	628532	4748064	185	1346	T23
O_2859	32.4	32.4	628545	4749267	181	1047	T23
O_2860	35.1	35.1	628545	4748162	185	1293	T23
O_2861	32.7	32.7	628548	4766811	186	821	T58

Receptor ID	2015 Results (2015 Amend- ment) Sound Level/ Night	2014 Results (2014 REA Sound Level/ Night	UTM Coordinates (NAD 83, Zone 17)		Z [m]	Distance to the nearest Turbine	Nearest Turbine ID
	dBA	dBA	X [m]	Y [m]			
O_2862	37.7	38.0	628549	4748136	185	1312	T23
O_2863	32.6	32.6	628552	4748053	185	1369	T23
O_2864	32.3	32.3	628552	4748030	185	1384	T23
O_2865	32.2	32.2	628557	4748163	185	1301	T23
O_2866	32.6	32.6	628561	4748131	185	1325	T23
O_2867	32.5	32.5	628567	4748056	185	1378	T23
O_2869	32.2	32.2	628572	4748123	185	1338	T23
O_2870	32.4	32.4	628576	4748152	185	1323	T23
O_2871	32.5	32.5	628578	4748034	185	1401	T23
O_2872	32.1	32.1	628579	4761757	185	1346	T29
O_2873	31.4	31.6	628580	4748056	185	1388	T23
O_2874	32.1	32.2	628581	4748116	185	1350	T23
O_2875	32.3	32.4	628586	4763901	185	806	T29
O_2876	38.4	38.5	628587	4748140	185	1339	T23
O_2877	32.4	32.4	628589	4748165	185	1325	T23
O_2878	32.5	32.5	628591	4748060	185	1393	T23
O_2879	32.1	32.1	616680	4752540	180	1396	T98
O_288	30.7	30.8	628592	4748035	185	1411	T23
O_2881	32.0	32.0	628596	4748104	185	1369	T23
O_2882	32.2	32.3	628601	4747963	184	1466	T23
O_2883	31.7	31.8	628603	4748165	185	1336	T23
O_2884	32.4	32.4	628603	4768282	190	666	T58
O_2885	38.3	38.5	628604	4748129	185	1359	T23
O_2886	32.3	32.3	628604	4766679	185	958	T58
O_2887	37.0	37.4	628606	4748066	185	1400	T23
O_2888	32.1	32.1	628607	4762414	180	695	T29
O_2889	36.8	36.9	616683	4753201	180	1308	T98
O_289	31.4	31.4	628609	4761726	185	1378	T29
O_2890	31.3	31.4	628612	4748097	185	1386	T23
O_2891	32.1	32.2	628612	4748042	185	1421	T23
O_2892	32.0	32.0	628617	4748071	185	1406	T23
O_2894	32.0	32.1	628619	4748119	185	1377	T23
O_2895	32.2	32.2	628621	4748158	185	1355	T23
O_2896	32.3	32.3	628630	4748046	185	1432	T23
O_2899	31.9	31.9	613184	4764691	182	1378	T08
O_29	31.3	31.3	616685	4764840	185	869	T39
O_290	37.5	37.5	628631	4748114	185	1390	T23
O_2900	32.1	32.1	628642	4748092	185	1412	T23
O_2902	32.0	32.0	628643	4748071	185	1426	T23
O_2903	31.9	31.9	628644	4748153	185	1376	T23
O_2904	32.2	32.2	628646	4748046	185	1444	T23
O_2905	31.8	31.9	628649	4761688	184	1420	T29
O_2907	31.0	31.2	628660	4748043	185	1457	T23
O_2909	31.8	31.8	616689	4769671	200	1357	T83
O_291	33.2	33.2	628661	4768255	190	654	T58
O_2910	38.4	38.6	628661	4748116	185	1412	T23
O_2911	32.0	32.0	628668	4748083	185	1437	T23
O_2912	31.9	31.9	628669	4748152	185	1397	T23
O_2913	32.1	32.1	628675	4748037	185	1472	T23
O_2915	31.7	31.7	628687	4748086	185	1451	T23
O_2917	31.8	31.8	628690	4748148	185	1416	T23
O_2918	32.0	32.0	628695	4748041	185	1485	T23
O_2919	31.6	31.6	616690	4769607	199	1408	T83
O_292	33.0	33.0	628696	4748062	185	1473	T23
O_2920	31.7	31.7	628698	4748101	185	1450	T23
O_2921	31.8	31.8	628703	4765352	185	582	T78
O_2922	39.2	39.4	628700	4763994	185	797	T78
O_2923	38.4	38.5	628709	4761647	184	1468	T29
O_2925	30.8	30.9	628713	4748074	185	1479	T23
O_2926	31.6	31.7	628714	4748143	185	1439	T23
O_2927	31.9	31.9	628716	4748110	185	1460	T23
O_2928	31.7	31.8	628716	4748046	185	1498	T23
O_2929	31.5	31.6	628720	4748184	185	1421	T23
O_2930	31.9	32.0	628724	4748091	185	1478	T23
O_2931	31.6	31.7	628730	4748114	185	1468	T23
O_2932	31.7	31.7	628742	4748102	185	1485	T23
O_2935	31.6	31.6	628749	4748208	185	1431	T23
O_2937	31.9	31.9	628751	4748130	185	1476	T23
O_2938	31.7	31.7	628752	4766880	189	800	T58
O_2940	37.7	38.0	628811	4763979	185	836	T78
O_2949	38.2	38.3	628817	4761935	180	1208	T29
O_2951	32.4	32.5	628817	4761709	183	1428	T29
O_2952	31.0	31.2	616705	4766250	189	794	T97
O_296	38.5	38.5	628885	4772422	185	1373	T80



Receptor ID	2015 Results (2015 Amend- ment) Sound Level/ Night	2014 Results (2014 REA Sound Level/ Night	UTM Coordinates (NAD 83, Zone 17)		Z [m]	Distance to the nearest Turbine	Nearest Turbine ID
	dBA	dBA	X [m]	Y [m]			
O_2960	31.2	31.2	628917	4768271	188	780	T58
O_2964	37.5	37.7	628942	4766756	189	990	T58
O_2967	36.9	37.4	616708	4763383	185	705	T51
O_297	39.3	39.3	629098	4764048	185	898	T78
O_2987	37.9	38.0	629134	4768816	185	1359	T58
O_2993	34.2	34.6	629134	4768523	185	1112	T58
O_2994	35.7	36.1	629147	4768284	185	939	T58
O_2998	37.0	37.4	629179	4772474	180	1120	T80
O_3002	33.0	33.0	629188	4764115	185	880	T03
O_3004	37.8	38.0	629188	4764072	185	854	T03
O_3005	37.9	38.0	629189	4768750	185	1325	T59
O_3006	34.5	34.9	616739	4768265	194	1357	T81
O_301	33.6	33.6	629217	4767955	185	798	T59
O_3012	38.7	39.0	629221	4768293	185	966	T59
O_3014	37.0	37.4	629229	4767241	185	850	T58
O_3016	38.5	38.9	616743	4767851	190	971	T81
O_302	35.3	35.3	629266	4766710	189	983	T18
O_3021	36.8	37.6	629268	4764095	185	804	T03
O_3023	37.9	38.0	629286	4763298	185	671	T03
O_3025	38.8	38.9	629300	4764159	185	823	T03
O_3026	37.8	37.9	629302	4767812	185	676	T59
O_3027	39.3	39.7	629319	4771724	187	905	T80
O_3029	35.6	35.6	629320	4767722	185	646	T59
O_3030	39.6	40.0	629324	4762740	182	901	T29
O_3031	36.2	36.3	629326	4767072	186	878	T59
O_3032	38.0	38.5	629339	4766729	189	930	T18
O_3033	37.0	37.8	629342	4765463	188	1021	T78
O_3035	36.1	36.7	629343	4763833	185	601	T03
O_3036	39.1	39.2	629352	4764867	185	775	T78
O_3039	37.2	37.4	629354	4765263	186	910	T78
O_3040	36.3	36.8	629354	4762097	179	1318	T29
O_3041	32.3	32.4	629355	4764103	185	744	T03
O_3043	38.0	38.1	629357	4765296	187	930	T78
O_3046	36.3	36.8	629357	4765167	186	866	T78
O_3047	36.5	36.9	629360	4765047	185	822	T78
O_3048	36.8	37.1	629360	4764369	185	882	T78
O_3049	37.4	37.5	629362	4764166	185	785	T03
O_3050	37.8	37.9	629373	4765934	188	805	T18
O_3051	36.3	37.3	629378	4765764	188	878	T18
O_3053	36.1	37.0	629381	4764460	185	862	T78
O_3055	37.2	37.4	629382	4764027	185	673	T03
O_3056	38.4	38.5	629384	4772373	180	891	T80
O_3057	35.0	35.1	629385	4765843	188	832	T18
O_3058	36.2	37.2	616788	4763650	185	843	T39
O_306	38.3	38.3	629387	4764508	185	851	T78
O_3060	37.2	37.4	629387	4762951	185	812	T03
O_3061	37.3	37.4	629387	4771422	187	976	T80
O_3062	35.4	35.4	629388	4764620	185	823	T78
O_3063	37.1	37.3	629391	4772685	185	1060	T80
O_3064	33.3	33.4	629393	4762366	184	1157	T29
O_3065	33.8	33.9	629393	4764248	185	828	T03
O_3066	37.6	37.7	629393	4766170	189	732	T18
O_3067	36.7	37.9	629397	4771847	185	801	T80
O_3068	36.5	36.5	629398	4772293	180	847	T80
O_3069	35.5	35.6	629398	4762039	183	1391	T29
O_3071	31.9	32.0	629401	4762305	184	1203	T29
O_3072	33.4	33.5	629401	4762237	182	1249	T29
O_3073	33.0	33.1	629402	4771595	186	875	T80
O_3074	36.1	36.1	629402	4772553	185	969	T80
O_3075	34.2	34.2	629402	4764284	185	852	T03
O_3076	37.5	37.6	629402	4765330	187	987	T78
O_3077	36.1	36.6	629403	4772607	185	1000	T80
O_3078	33.9	33.9	629406	4772028	185	781	T80
O_3079	36.5	36.5	629407	4765239	186	943	T78
O_3080	36.2	36.7	629408	4764174	185	760	T03
O_3081	37.8	37.9	629409	4766070	189	731	T18
O_3082	36.7	37.8	629410	4762205	180	1278	T29
O_3083	32.8	32.9	629411	4762630	182	1027	T29
O_3084	35.3	35.4	629415	4764124	185	718	T03
O_3085	38.0	38.2	629416	4771069	190	1123	T79
O_3086	34.1	34.1	629417	4762131	175	1336	T29
O_3087	32.2	32.3	629418	4765276	187	971	T78
O_3088	36.1	36.6	616802	4769948	198	1245	T83
O_309	33.6	33.6	629423	4768195	185	750	T59

Receptor ID	2015 Results (2015 Amend- ment) Sound Level/ Night	2014 Results (2014 REA Sound Level/ Night	UTM Coordinates (NAD 83, Zone 17)		Z [m]	Distance to the nearest Turbine	Nearest Turbine ID
	dBA	dBA	X [m]	Y [m]			
O_3090	38.0	38.5	629431	4765990	188	732	T18
O_3091	36.6	37.8	629440	4771774	185	775	T80
O_3092	36.9	36.9	629442	4771747	185	781	T80
O_3093	36.9	36.9	629455	4765226	186	980	T78
O_3095	36.0	36.5	629475	4764211	185	750	T03
O_3097	37.7	37.9	629476	4764261	185	791	T03
O_3098	37.5	37.7	629479	4772495	180	872	T80
O_3100	35.2	35.2	629502	4764502	185	963	T78
O_3102	36.8	37.0	629507	4764337	185	843	T03
O_3103	37.2	37.4	629516	4771517	185	817	T80
O_3105	37.0	37.0	629518	4771765	185	703	T80
O_3106	37.8	37.8	629518	4772160	183	691	T80
O_3107	37.4	37.4	629528	4770594	190	1349	T79
O_3109	32.4	32.5	629540	4764147	185	661	T03
O_3111	38.2	38.4	629540	4765971	189	637	T18
O_3112	37.2	38.5	629548	4772711	185	967	T80
O_3113	34.2	34.2	629556	4764234	185	728	T03
O_3115	37.7	37.8	629568	4764156	185	654	T03
O_3116	38.3	38.4	629577	4768185	185	639	T59
O_3117	38.9	39.4	616817	4753735	180	1354	T98
O_312	31.7	31.7	629582	4770783	186	1172	T79
O_3120	33.5	33.6	629606	4764250	185	721	T03
O_3122	37.7	37.8	629621	4762383	181	1234	T03
O_3125	33.4	33.5	629632	4764175	185	643	T03
O_3126	38.3	38.4	629647	4764257	185	712	T03
O_3128	37.7	37.8	629667	4768216	185	617	T59
O_3130	39.1	39.7	629688	4764157	185	604	T03
O_3133	38.6	38.7	629724	4770707	185	1140	T79
O_3135	33.6	33.7	629824	4772622	183	733	T80
O_3138	36.6	36.7	616841	4766189	189	663	T97
O_314	38.9	38.9	629915	4765308	188	944	T18
O_3141	35.0	36.0	629923	4772624	184	692	T80
O_3143	37.2	37.2	629933	4764309	185	723	T03
O_3144	37.1	37.2	629952	4770636	185	1090	T79
O_3145	33.8	33.9	629968	4768328	187	652	T59
O_3146	38.9	39.6	629971	4772629	183	680	T80
O_3147	37.3	37.3	630028	4772631	181	666	T80
O_3150	37.5	37.5	630049	4772629	181	659	T80
O_3153	37.6	37.6	630077	4772627	181	652	T80
O_3154	37.7	37.7	630096	4772635	181	657	T80
O_3155	37.7	37.7	630098	4770737	184	944	T79
O_3156	34.9	35.0	630112	4772634	181	655	T80
O_3157	37.7	37.7	630112	4764401	186	843	T03
O_3158	35.9	36.1	630120	4762457	183	1154	T03
O_3159	32.8	32.8	616853	4753410	180	1187	T98
O_316	32.3	32.3	630171	4764294	186	760	T03
O_3161	36.4	36.6	630205	4764058	185	565	T03
O_3163	38.6	38.6	630211	4770734	184	919	T79
O_3164	35.1	35.1	630237	4768317	187	637	T60
O_3166	38.8	39.7	630267	4772592	179	613	T80
O_3167	38.3	38.3	630298	4766936	190	728	T18
O_3168	38.8	40.0	630302	4762506	184	1157	T03
O_3169	32.5	32.6	616853	4753307	180	1159	T98
O_317	32.4	32.4	630312	4772528	176	559	T80
O_3172	39.2	39.2	630316	4763230	185	556	T03
O_3173	38.5	38.5	630329	4772606	175	638	T80
O_3174	38.0	38.0	630331	4766793	190	602	T18
O_3175	38.6	40.0	630362	4764424	187	960	T03
O_3176	34.7	35.0	630401	4772642	175	692	T80
O_3178	37.4	37.4	630421	4764377	187	951	T03
O_3179	34.7	34.9	616856	4771254	193	1058	T88
O_318	34.5	34.6	630433	4768265	187	604	T60
O_3180	38.6	39.6	630445	4768333	187	672	T60
O_3181	37.7	38.8	630448	4770760	184	879	T79
O_3182	35.3	35.4	630466	4763116	185	744	T03
O_3183	36.0	36.0	630469	4770621	185	1019	T79
O_3184	34.1	36.0	630491	4766885	190	753	T18
O_3187	37.9	39.1	630504	4770660	185	984	T79
O_3189	34.4	34.4	616880	4768207	193	1351	T81
O_319	33.9	33.9	630537	4766889	190	780	T18
O_3191	37.6	38.9	630538	4770754	185	896	T79
O_3192	35.1	35.2	630551	4772660	180	768	T80
O_3193	36.6	36.6	630576	4764410	188	1071	T03
O_3194	33.7	34.0	630587	4772655	180	781	T80

Receptor ID	2015 Results (2015 Amend- ment) Sound Level/ Night	2014 Results (2014 REA Sound Level/ Night	UTM Coordinates (NAD 83, Zone 17)		Z [m]	Distance to the nearest Turbine	Nearest Turbine ID
	dBA	dBA	X [m]	Y [m]			
O_3195	36.5	36.5	630596	4768345	186	736	T60
O_3196	36.8	37.8	630635	4768286	186	702	T60
O_3197	37.0	38.1	630640	4764516	189	1193	T03
O_3198	33.1	33.5	613320	4764699	185	1243	T08
O_32	32.1	32.1	616900	4753630	180	1231	T98
O_320	32.3	32.3	630699	4770660	180	1027	T79
O_3202	33.9	34.0	630720	4764407	189	1165	T03
O_3204	33.0	33.3	630804	4764082	188	1038	T03
O_3206	33.5	33.7	630811	4770764	180	971	T79
O_3207	34.3	34.4	630819	4772667	181	931	T80
O_3208	35.1	35.1	630826	4772734	184	986	T80
O_3209	34.5	34.5	616900	4752401	180	1257	T98
O_321	31.6	31.6	630894	4772746	182	1040	T80
O_3211	34.0	34.0	630918	4764626	190	1460	T03
O_3212	31.7	32.2	630929	4771501	184	562	T79
O_3213	39.2	39.2	630930	4772674	180	1014	T80
O_3214	34.3	34.4	630939	4764497	190	1387	T03
O_3215	31.8	32.2	630975	4764619	190	1496	T03
O_3216	31.5	32.0	631003	4764528	190	1456	T03
O_3217	31.5	31.9	631016	4772782	182	1151	T80
O_3218	33.1	33.1	631029	4772740	181	1132	T80
O_3219	33.3	33.3	631042	4772683	180	1105	T80
O_3222	33.6	33.6	631043	4772073	180	790	T79
O_3223	37.2	37.2	631065	4765902	190	997	T18
O_3225	33.0	34.4	616908	4763380	185	639	T51
O_323	39.9	39.9	631121	4770571	185	1296	T79
O_3230	31.9	32.0	631133	4770475	185	1382	T79
O_3232	31.4	31.6	631162	4768311	185	1085	T60
O_3236	33.2	34.2	631179	4771200	181	907	T79
O_3239	34.9	34.9	631179	4768810	185	1444	T60
O_3240	31.2	32.1	631192	4771191	180	923	T79
O_3243	34.8	34.8	631194	4771305	180	875	T79
O_3244	35.3	35.3	631197	4767565	185	927	T60
O_3246	34.5	35.7	631209	4771190	180	938	T79
O_3247	34.6	34.6	631213	4768277	185	1109	T60
O_3248	33.0	34.0	631226	4771189	181	954	T79
O_3252	34.5	34.5	631231	4771238	180	937	T79
O_3253	34.6	34.7	631237	4771182	182	967	T79
O_3254	34.3	34.4	631237	4767355	185	1014	T60
O_3255	34.0	35.2	631246	4771269	180	938	T79
O_3256	34.6	34.7	631246	4771193	182	970	T79
O_3257	34.3	34.4	631247	4765249	190	1491	T18
O_3258	30.7	31.6	631248	4771260	180	943	T79
O_3259	34.6	34.6	616928	4767591	190	855	T81
O_326	36.3	36.3	631251	4771283	180	937	T79
O_3262	34.6	34.7	631254	4771245	180	954	T79
O_3263	34.5	34.5	631254	4771208	181	970	T79
O_3264	34.3	34.4	631257	4771307	180	933	T79
O_3265	34.7	34.7	631257	4771296	180	937	T79
O_3266	34.7	34.7	631260	4771320	180	932	T79
O_3267	34.7	34.7	631263	4771214	182	975	T79
O_3268	34.3	34.3	631266	4771335	180	932	T79
O_3269	34.7	34.7	616931	4761298	180	1285	T09
O_327	32.9	32.9	631269	4766911	189	1256	T60
O_3270	33.1	34.3	631271	4771347	180	933	T79
O_3271	34.7	34.7	631274	4765985	190	1177	T18
O_3273	32.0	33.2	631279	4771354	180	939	T79
O_3275	34.7	34.7	631279	4771262	181	970	T79
O_3276	34.3	34.4	631280	4766492	190	1187	T18
O_3277	32.6	33.8	631280	4771189	184	1002	T79
O_3278	34.0	34.1	631283	4771277	180	968	T79
O_3279	34.4	34.4	616935	4761352	180	1232	T09
O_328	33.2	33.3	631285	4771260	181	977	T79
O_3280	34.3	34.3	631285	4771361	180	943	T79
O_3281	34.6	34.7	631285	4771273	180	972	T79
O_3282	34.3	34.4	631288	4771295	180	967	T79
O_3283	34.4	34.4	631289	4771324	180	957	T79
O_3284	34.5	34.5	631289	4771309	180	962	T79
O_3285	34.4	34.5	631289	4771325	180	957	T79
O_3286	34.5	34.5	631290	4771308	180	963	T79
O_3288	34.4	34.4	631290	4771285	180	972	T79
O_3289	34.3	34.4	631290	4771295	180	968	T79
O_3290	34.4	34.4	631290	4771285	180	972	T79
O_3291	34.3	34.4	631296	4771372	180	950	T79

Receptor ID	2015 Results (2015 Amend- ment) Sound Level/ Night	2014 Results (2014 REA Sound Level/ Night	UTM Coordinates (NAD 83, Zone 17)		Z [m]	Distance to the nearest Turbine	Nearest Turbine ID
	dBA	dBA	X [m]	Y [m]			
O_3293	34.6	34.6	631298	4771332	180	963	T79
O_3294	34.4	34.5	631298	4771191	184	1017	T79
O_3295	33.9	33.9	631299	4771331	180	964	T79
O_3296	34.4	34.4	631299	4771262	181	989	T79
O_3297	34.2	34.2	631300	4765347	190	1472	T18
O_3298	30.7	31.6	631303	4765483	190	1396	T18
O_3299	30.9	31.9	631307	4771338	180	970	T79
O_3300	34.4	34.4	631307	4771384	180	957	T79
O_3301	34.5	34.5	631307	4771338	180	970	T79
O_3302	34.4	34.4	631307	4771273	181	992	T79
O_3303	34.1	34.2	631313	4771279	181	995	T79
O_3304	34.1	34.1	631316	4771241	182	1013	T79
O_3305	33.9	34.0	631317	4771189	184	1035	T79
O_3306	33.7	33.8	631318	4771393	180	965	T79
O_3307	34.4	34.5	631318	4771288	180	997	T79
O_3308	34.1	34.1	631318	4771347	180	978	T79
O_3309	34.3	34.3	616942	4752377	180	1235	T98
O_331	31.7	31.7	631318	4771345	180	979	T79
O_3310	34.3	34.3	631320	4771304	180	993	T79
O_3311	34.1	34.2	631322	4767144	185	1175	T60
O_3312	33.1	34.3	631324	4771363	180	979	T79
O_3313	34.3	34.3	631325	4771316	180	994	T79
O_3315	34.1	34.2	616948	4752188	180	1341	T98
O_332	31.1	31.1	631328	4771361	180	984	T79
O_3320	34.2	34.3	631329	4771247	181	1023	T79
O_3321	33.9	33.9	631331	4771404	180	975	T79
O_3323	34.3	34.4	631332	4771368	180	986	T79
O_3325	34.2	34.3	631334	4771367	180	987	T79
O_3327	34.2	34.2	631334	4771332	180	997	T79
O_3328	34.1	34.1	631336	4771422	180	976	T79
O_3329	34.3	34.4	616953	4761501	180	1087	T09
O_333	34.3	34.4	631337	4771187	183	1054	T79
O_3330	33.6	33.6	631338	4771558	180	958	T79
O_3331	34.6	34.6	631342	4766557	190	1263	T18
O_3332	32.3	33.5	631344	4771379	180	994	T79
O_3333	34.2	34.2	631344	4771513	180	968	T79
O_3334	34.5	34.5	631345	4771339	180	1006	T79
O_3335	34.0	34.1	631346	4771255	180	1035	T79
O_3337	33.7	33.8	631348	4771431	180	986	T79
O_3338	34.3	34.3	631348	4771380	180	998	T79
O_3339	34.1	34.2	616962	4761288	180	1300	T09
O_334	32.8	32.8	631349	4771266	180	1034	T79
O_3340	33.8	33.8	631354	4771384	180	1002	T79
O_3341	34.1	34.1	631354	4771295	180	1029	T79
O_3342	33.8	33.9	631354	4771189	182	1068	T79
O_3343	33.5	33.5	631356	4771285	180	1034	T79
O_3344	33.8	33.8	631356	4767756	185	1082	T60
O_3345	33.2	34.3	631358	4771344	180	1017	T79
O_3346	33.9	34.0	631358	4771307	180	1028	T79
O_3347	33.8	33.9	631361	4766038	190	1253	T18
O_3348	31.6	32.8	631361	4771435	180	998	T79
O_3349	34.2	34.2	616965	4767579	190	872	T81
O_335	36.3	36.3	631364	4763681	186	1476	T03
O_3350	30.3	30.5	631365	4771446	180	999	T79
O_3351	34.1	34.2	631365	4771192	182	1077	T79
O_3352	33.4	33.4	631367	4771308	180	1037	T79
O_3353	33.8	33.8	631368	4771458	180	1001	T79
O_3354	34.1	34.2	631369	4771499	180	995	T79
O_3355	34.2	34.2	631370	4771377	180	1020	T79
O_3356	33.9	34.0	631371	4771468	180	1002	T79
O_3357	34.1	34.2	631372	4771347	180	1029	T79
O_3358	33.8	33.9	631373	4771486	180	1000	T79
O_3359	34.2	34.2	616972	4753658	180	1182	T98
O_336	32.6	32.6	631373	4771410	180	1014	T79
O_3360	34.0	34.0	631377	4771191	181	1089	T79
O_3361	33.3	33.3	631380	4771370	180	1031	T79
O_3362	33.8	33.9	631380	4771402	180	1023	T79
O_3363	33.9	33.9	631382	4771349	180	1039	T79
O_3364	33.8	33.8	631386	4771360	180	1040	T79
O_3365	33.7	33.8	631387	4771317	180	1053	T79
O_3366	33.6	33.7	631390	4771193	181	1100	T79
O_3367	33.2	33.2	631394	4771402	180	1037	T79
O_3369	33.8	33.8	631400	4771313	180	1067	T79
O_3370	33.5	33.5	631402	4771301	180	1072	T79

Receptor ID	2015 Results (2015 Amend- ment) Sound Level/ Night	2014 Results (2014 REA Sound Level/ Night	UTM Coordinates (NAD 83, Zone 17)		Z [m]	Distance to the nearest Turbine	Nearest Turbine ID
	dBA	dBA	X [m]	Y [m]			
O_3371	33.4	33.5	631404	4771195	180	1112	T79
O_3373	33.1	33.1	631409	4771259	180	1093	T79
O_3374	33.3	33.3	631410	4771269	180	1090	T79
O_3375	33.3	33.3	631411	4771195	180	1118	T79
O_3376	33.0	33.1	631411	4771285	180	1086	T79
O_3377	33.3	33.4	631412	4765515	190	1474	T18
O_3378	30.5	31.5	616977	4764788	185	631	T39
O_338	39.3	39.3	631419	4771377	180	1067	T79
O_3380	33.5	33.6	631420	4771366	180	1071	T79
O_3381	33.5	33.5	631424	4771441	180	1058	T79
O_3382	33.6	33.7	631427	4771200	180	1130	T79
O_3385	32.9	33.0	631427	4771426	180	1064	T79
O_3387	33.6	33.6	631432	4771333	180	1092	T79
O_3388	33.3	33.3	631435	4771414	180	1074	T79
O_3389	33.5	33.5	617003	4763469	185	717	T51
O_339	39.4	39.4	631435	4771320	180	1098	T79
O_3390	33.2	33.3	631436	4771402	180	1077	T79
O_3391	33.4	33.5	631439	4771391	180	1084	T79
O_3392	33.4	33.4	631439	4771304	180	1107	T79
O_3393	33.2	33.2	631441	4771375	180	1089	T79
O_3394	33.3	33.4	631441	4771211	180	1140	T79
O_3395	32.9	32.9	631445	4771257	180	1127	T79
O_3396	33.0	33.0	631445	4771227	180	1137	T79
O_3397	32.9	32.9	631446	4771291	180	1117	T79
O_3398	33.1	33.1	631446	4771241	180	1134	T79
O_3399	32.9	33.0	613403	4767688	195	1414	T52
O_34	31.3	31.3	617008	4761498	180	1100	T09
O_340	34.3	34.3	631449	4771333	180	1108	T79
O_3401	33.2	33.2	631451	4771347	180	1106	T79
O_3402	33.2	33.2	631455	4766912	189	1407	T60
O_3403	32.1	33.2	631455	4771322	180	1117	T79
O_3404	33.1	33.1	631460	4771305	180	1126	T79
O_3405	33.0	33.0	631464	4771272	180	1140	T79
O_3407	32.9	32.9	631469	4771241	180	1156	T79
O_3409	32.8	32.8	617011	4764858	185	670	T39
O_341	39.2	39.3	631471	4771255	180	1152	T79
O_3410	32.8	32.8	631472	4771413	180	1111	T79
O_3411	33.2	33.2	631472	4771386	180	1117	T79
O_3412	33.1	33.1	631473	4771438	180	1107	T79
O_3413	33.2	33.2	631473	4771400	180	1114	T79
O_3414	33.1	33.2	631473	4771232	180	1162	T79
O_3415	32.7	32.8	631476	4771201	180	1176	T79
O_3416	32.6	32.6	631476	4771372	180	1124	T79
O_3418	33.0	33.1	631477	4771218	180	1171	T79
O_3419	32.6	32.7	617013	4753575	180	1106	T98
O_342	33.1	33.1	631478	4771189	180	1182	T79
O_3420	32.5	32.6	631479	4771351	180	1132	T79
O_3421	33.0	33.0	631481	4771364	180	1130	T79
O_3422	33.0	33.0	631483	4771341	180	1138	T79
O_3423	32.9	33.0	631483	4771325	180	1142	T79
O_3424	32.9	32.9	631484	4771441	180	1117	T79
O_3425	33.1	33.2	631485	4771417	180	1123	T79
O_3426	33.1	33.1	631486	4771393	180	1128	T79
O_3427	33.0	33.1	631487	4771314	180	1149	T79
O_3428	32.8	32.9	631487	4771380	180	1133	T79
O_3429	33.0	33.0	617014	4752344	180	1194	T98
O_343	32.0	32.0	631488	4771406	180	1128	T79
O_3430	33.0	33.1	631491	4771369	180	1139	T79
O_3431	32.9	33.0	631491	4771290	180	1160	T79
O_3432	32.7	32.8	631493	4771357	180	1143	T79
O_3433	32.9	32.9	631495	4771346	180	1149	T79
O_3434	32.8	32.9	631495	4771262	180	1173	T79
O_3435	32.6	32.7	631496	4771336	180	1152	T79
O_3436	32.8	32.8	631498	4771316	180	1159	T79
O_3437	32.7	32.8	631498	4771248	180	1180	T79
O_3438	32.6	32.6	631500	4771438	180	1134	T79
O_3439	33.0	33.0	617014	4769829	196	1486	T83
O_344	33.0	33.0	631504	4771225	180	1193	T79
O_3440	32.5	32.5	631505	4771214	180	1198	T79
O_3441	32.4	32.5	631506	4771200	180	1204	T79
O_3442	32.4	32.4	631511	4771436	180	1145	T79
O_3443	32.9	32.9	631514	4771409	180	1153	T79
O_3444	32.8	32.9	631516	4771394	180	1157	T79
O_3445	32.8	32.8	631518	4771381	180	1162	T79



Receptor ID	2015 Results (2015 Amend- ment) Sound Level/ Night	2014 Results (2014 REA Sound Level/ Night	UTM Coordinates (NAD 83, Zone 17)		Z [m]	Distance to the nearest Turbine	Nearest Turbine ID
	dBA	dBA	X [m]	Y [m]			
O_3446	32.7	32.8	631518	4771369	180	1165	T79
O_3447	32.7	32.8	631519	4771355	180	1169	T79
O_3448	32.7	32.7	631526	4771243	180	1208	T79
O_3450	32.4	32.4	631526	4771341	180	1180	T79
O_3451	32.6	32.6	631526	4771204	180	1222	T79
O_3452	32.2	32.3	631528	4771381	180	1172	T79
O_3453	32.7	32.7	631528	4771221	180	1218	T79
O_3454	32.3	32.3	631529	4771406	180	1168	T79
O_3455	32.7	32.7	631531	4771370	180	1178	T79
O_3456	32.6	32.7	631550	4771399	180	1190	T79
O_3458	32.5	32.6	631554	4771378	180	1198	T79
O_3459	32.5	32.5	617022	4754066	180	1403	T98
O_346	32.2	32.2	631554	4771364	180	1202	T79
O_3460	32.4	32.5	631555	4771281	180	1224	T79
O_3461	32.2	32.3	631559	4771264	180	1233	T79
O_3462	32.2	32.2	631562	4771291	180	1228	T79
O_3463	32.2	32.3	631565	4771243	180	1245	T79
O_3464	32.1	32.1	631565	4771233	180	1249	T79
O_3465	32.0	32.1	631568	4771443	180	1200	T79
O_3466	32.5	32.5	631568	4771305	180	1230	T79
O_3467	32.2	32.2	631568	4771218	180	1256	T79
O_3468	32.0	32.0	631570	4771206	180	1261	T79
O_3469	31.9	32.0	617025	4766263	189	650	T97
O_347	38.9	38.9	631571	4771314	180	1230	T79
O_3470	32.2	32.2	631573	4771387	180	1215	T79
O_3471	32.3	32.4	631576	4771327	180	1232	T79
O_3472	32.2	32.2	631578	4771368	180	1224	T79
O_3473	32.3	32.3	631579	4771343	180	1230	T79
O_3474	32.2	32.3	631580	4771450	180	1210	T79
O_3475	32.4	32.4	631580	4771355	180	1229	T79
O_3476	32.2	32.3	631582	4771279	180	1250	T79
O_3477	32.0	32.1	631584	4771269	180	1256	T79
O_3478	32.0	32.1	631587	4771252	180	1263	T79
O_3479	31.9	32.0	617029	4752154	180	1303	T98
O_348	31.4	31.4	631591	4771290	180	1256	T79
O_3480	32.0	32.1	631591	4771241	180	1271	T79
O_3481	31.9	31.9	631591	4771227	180	1275	T79
O_3482	31.9	31.9	631592	4771457	180	1221	T79
O_3483	32.3	32.3	631593	4771215	180	1280	T79
O_3484	31.8	31.9	631594	4771279	180	1262	T79
O_3485	32.0	32.0	631597	4771201	180	1288	T79
O_3486	31.8	31.8	631598	4771267	180	1269	T79
O_3487	31.9	32.0	631602	4771381	180	1244	T79
O_3488	32.1	32.2	631602	4771250	180	1278	T79
O_3489	31.8	31.9	617030	4753552	180	1079	T98
O_349	33.2	33.2	631604	4771463	180	1233	T79
O_3490	32.2	32.3	631605	4771238	180	1285	T79
O_3491	31.8	31.8	631605	4771226	180	1289	T79
O_3492	31.8	31.8	631605	4771208	180	1295	T79
O_3493	31.7	31.8	631608	4771349	180	1257	T79
O_3494	32.0	32.1	631610	4771424	180	1245	T79
O_3495	32.1	32.2	631615	4771309	180	1274	T79
O_3496	31.9	31.9	631616	4771275	180	1284	T79
O_3497	31.8	31.9	631617	4771465	180	1245	T79
O_3498	32.1	32.2	631617	4771388	180	1258	T79
O_3499	32.0	32.1	631619	4771263	180	1290	T79
O_3500	31.7	31.8	631622	4771251	180	1297	T79
O_3501	31.7	31.8	631623	4771238	180	1302	T79
O_3502	31.7	31.7	631625	4771432	180	1258	T79
O_3503	32.0	32.1	631626	4771356	180	1273	T79
O_3504	31.9	31.9	631627	4771224	180	1310	T79
O_3505	31.6	31.7	631628	4771278	180	1295	T79
O_3506	31.7	31.8	631628	4771210	180	1316	T79
O_3507	31.6	31.6	631630	4771314	180	1287	T79
O_3508	31.8	31.8	631630	4771436	180	1262	T79
O_3509	32.0	32.0	617040	4753351	180	991	T98
O_351	33.7	33.7	631630	4771263	180	1301	T79
O_3510	31.7	31.7	631631	4771199	180	1322	T79
O_3511	31.5	31.6	631632	4771474	180	1259	T79
O_3512	32.0	32.1	631637	4771238	180	1315	T79
O_3513	31.6	31.6	631637	4771401	180	1275	T79
O_3514	31.9	31.9	631637	4771250	180	1312	T79
O_3515	31.6	31.7	631638	4771443	180	1269	T79
O_3516	31.9	32.0	631639	4771363	180	1285	T79

Receptor ID	2015 Results (2015 Amend- ment) Sound Level/ Night	2014 Results (2014 REA Sound Level/ Night	UTM Coordinates (NAD 83, Zone 17)		Z [m]	Distance to the nearest Turbine	Nearest Turbine ID
	dBA	dBA	X [m]	Y [m]			
O_3517	31.8	31.9	631640	4771322	180	1295	T79
O_3518	31.7	31.8	631641	4771211	180	1327	T79
O_3519	31.5	31.5	617042	4752319	180	1186	T98
O_352	32.0	32.0	631642	4771224	180	1324	T79
O_3520	31.5	31.6	631643	4771479	180	1269	T79
O_3521	31.9	32.0	631646	4771450	180	1276	T79
O_3522	31.9	31.9	631648	4771296	180	1309	T79
O_3523	31.6	31.7	631649	4771281	180	1314	T79
O_3524	31.6	31.6	631652	4771327	180	1305	T79
O_3525	31.7	31.7	631652	4771492	180	1276	T79
O_3526	31.9	31.9	631653	4771410	180	1289	T79
O_3527	31.8	31.8	631655	4771268	180	1324	T79
O_3528	31.5	31.6	631656	4771371	180	1300	T79
O_3529	31.7	31.8	631657	4771255	180	1329	T79
O_3530	31.5	31.5	631658	4771457	180	1287	T79
O_3531	31.8	31.9	631661	4771505	180	1283	T79
O_3532	31.9	31.9	631661	4771335	180	1312	T79
O_3533	31.6	31.7	631661	4771242	180	1337	T79
O_3534	31.4	31.5	631663	4771228	180	1343	T79
O_3535	31.4	31.4	631664	4771417	180	1299	T79
O_3536	31.7	31.8	631664	4771295	180	1325	T79
O_3537	31.5	31.6	631665	4771515	180	1287	T79
O_3538	31.8	31.9	631665	4771215	180	1349	T79
O_3539	31.3	31.4	617052	4761555	180	1054	T09
O_354	34.7	34.7	631665	4771462	180	1293	T79
O_3540	31.8	31.8	631667	4771377	180	1309	T79
O_3541	31.6	31.7	631668	4771281	180	1333	T79
O_3542	31.4	31.5	631668	4771203	181	1356	T79
O_3543	31.3	31.4	631671	4771267	180	1339	T79
O_3544	31.4	31.5	631674	4771470	180	1301	T79
O_3545	31.7	31.8	631675	4771254	180	1346	T79
O_3546	31.4	31.4	631675	4771340	180	1325	T79
O_3547	31.5	31.6	631677	4771239	180	1353	T79
O_3548	31.3	31.4	631678	4771424	180	1311	T79
O_3549	31.6	31.7	631679	4771230	180	1357	T79
O_3550	31.3	31.3	631680	4771215	181	1363	T79
O_3551	31.2	31.3	631681	4771478	180	1306	T79
O_3552	31.7	31.7	631681	4771386	180	1321	T79
O_3553	31.5	31.6	631683	4771309	180	1340	T79
O_3554	31.4	31.5	631685	4771297	180	1345	T79
O_3555	31.4	31.4	631685	4771283	180	1349	T79
O_3556	31.3	31.4	631688	4771484	180	1312	T79
O_3557	31.6	31.7	631689	4771346	180	1337	T79
O_3558	31.4	31.5	631691	4771432	180	1323	T79
O_3559	31.5	31.6	617054	4753518	180	1042	T98
O_356	33.5	33.5	631692	4771269	180	1359	T79
O_3560	31.3	31.3	631693	4771322	180	1347	T79
O_3561	31.4	31.4	631693	4771253	180	1364	T79
O_3562	31.2	31.3	631694	4771241	180	1369	T79
O_3563	31.2	31.3	631696	4771400	180	1333	T79
O_3564	31.5	31.5	631697	4771227	181	1375	T79
O_3565	31.2	31.2	631698	4771311	180	1353	T79
O_3566	31.3	31.4	631701	4771216	181	1383	T79
O_3567	31.1	31.2	631701	4771355	180	1347	T79
O_3568	31.4	31.4	631703	4771200	181	1389	T79
O_3569	31.1	31.1	617066	4771041	195	1251	T88
O_357	33.5	33.5	631706	4771294	180	1366	T79
O_3570	31.2	31.3	631707	4771280	180	1370	T79
O_3571	31.2	31.3	631710	4771253	180	1381	T79
O_3572	31.1	31.2	631711	4771268	180	1378	T79
O_3573	31.1	31.2	631713	4771240	180	1387	T79
O_3574	31.1	31.1	631717	4771228	181	1394	T79
O_3575	31.0	31.1	631719	4771213	181	1400	T79
O_3576	31.0	31.1	617076	4761329	180	1280	T09
O_359	33.0	33.0	617078	4761475	180	1138	T09
O_360	34.0	34.1	631154	4772066	180	881	T79
O_3609	36.0	36.0	631445	4770958	182	1260	T79
O_3614	32.0	32.0	617085	4770150	195	1384	T83
O_362	33.1	33.2	617088	4752282	180	1174	T98
O_363	32.1	32.1	631354	4768192	185	1191	T60
O_3630	32.4	33.4	631420	4767947	185	1173	T60
O_3631	32.5	33.5	631694	4767869	185	1428	T60
O_3632	30.9	31.9	631642	4767730	185	1365	T60
O_3633	31.3	32.3	631701	4767230	188	1494	T60

Receptor ID	2015 Results (2015 Amend- ment) Sound Level/ Night	2014 Results (2014 REA Sound Level/ Night	UTM Coordinates (NAD 83, Zone 17)		Z [m]	Distance to the nearest Turbine	Nearest Turbine ID
	dBA	dBA	X [m]	Y [m]			
O_3637	31.0	32.0	631502	4766874	190	1467	T60
O_3641	31.8	32.9	631531	4766979	188	1437	T60
O_3643	31.7	32.8	631392	4766256	190	1270	T18
O_3645	31.7	32.9	617106	4753383	180	940	T98
O_367	34.2	34.2	617107	4764795	185	570	T39
O_368	40.0	40.0	617946	4749326	180	1266	T99
O_3684	32.0	32.1	617081	4752007	180	1373	T98
O_3689	31.0	31.0	613520	4764532	185	1092	T08
O_37	32.9	33.0	614637	4770098	200	1336	T83
O_3703	32.1	32.2	631075	4772971	182	1329	T80
O_3704	31.6	31.6	631140	4772702	180	1194	T80
O_3705	32.9	32.9	617115	4761467	180	1156	T09
O_372	34.0	34.0	617120	4761409	180	1213	T09
O_373	33.5	33.6	617131	4752087	180	1279	T98
O_375	31.5	31.5	617149	4771162	195	1338	T88
O_377	32.8	32.8	617159	4753504	180	944	T98
O_378	34.2	34.3	617171	4755339	180	1291	T82
O_381	32.1	32.1	623726	4762663	177	1406	T36
O_3826	33.3	33.8	617182	4753468	180	906	T98
O_383	34.5	34.5	628108	4748075	183	1064	T23
O_3846	34.4	34.4	627732	4748213	180	785	T23
O_3847	37.0	37.0	627743	4748209	180	792	T23
O_3848	37.0	37.0	617196	4753357	180	846	T98
O_385	35.0	35.0	627925	4748226	185	842	T23
O_3851	36.2	36.3	628359	4747978	180	1290	T23
O_3852	32.8	32.8	628374	4747972	180	1304	T23
O_3853	32.7	32.7	627588	4748288	180	688	T23
O_3854	38.3	38.3	627506	4748265	180	710	T23
O_3855	38.3	38.3	627213	4748301	180	721	T49
O_3856	39.1	39.1	627198	4748299	180	715	T49
O_3857	39.1	39.1	626251	4747899	181	1077	T61
O_3858	37.6	37.6	626321	4747961	180	1084	T49
O_3859	37.6	37.6	617203	4755320	180	1254	T82
O_386	32.3	32.3	626343	4747992	180	1047	T49
O_3860	37.6	37.6	626252	4747852	180	1081	T61
O_3864	37.5	37.5	626343	4747690	180	1199	T61
O_3865	36.5	36.6	626340	4747669	180	1201	T61
O_3866	36.5	36.5	626336	4747652	180	1202	T61
O_3867	36.4	36.4	626323	4747633	180	1194	T61
O_3868	36.4	36.4	626314	4747623	180	1189	T61
O_3869	36.4	36.4	625872	4747344	183	935	T61
O_3870	37.2	37.3	625814	4747285	184	936	T61
O_3871	37.2	37.2	625632	4747199	182	896	T61
O_3872	37.4	37.5	625155	4746600	184	1370	T61
O_3873	34.7	34.8	625126	4746569	183	1402	T61
O_3874	34.5	34.6	625393	4746711	184	1277	T61
O_3879	34.9	35.0	625420	4746669	180	1324	T61
O_3880	34.6	34.7	625439	4746710	180	1287	T61
O_3881	34.8	34.9	619787	4766229	188	654	T54
O_3887	38.9	38.9	617216	4754442	180	1266	T82
O_390	32.9	32.9	631337	4766911	189	1311	T60
O_3903	32.7	33.9	631377	4766781	190	1370	T18
O_3904	32.4	33.5	617228	4754548	180	1219	T82
O_392	33.0	33.0	613583	4764565	185	1022	T08
O_40	33.5	33.5	623313	4768678	195	779	T27
O_4001	38.7	38.7	617251	4767706	191	1171	T81
O_402	35.6	35.6	613595	4766009	190	811	T52
O_41	36.8	36.8	617318	4753434	180	771	T98
O_412	35.8	35.8	617342	4764890	185	610	T39
O_416	40.0	40.0	613613	4767611	195	1237	T52
O_42	32.5	32.5	613659	4766095	190	706	T52
O_43	37.8	37.8	617404	4754760	180	998	T82
O_431	34.1	34.1	617459	4753423	180	646	T98
O_437	37.3	37.3	613659	4764467	185	990	T08
O_44	33.7	33.7	617474	4753582	180	741	T98
O_441	36.3	36.3	617504	4753535	180	686	T98
O_445	36.9	36.9	613695	4765962	190	770	T52
O_45	37.4	37.4	617519	4767706	191	991	T93
O_451	36.2	36.2	617562	4754870	180	829	T82
O_456	35.5	35.5	617574	4753578	180	673	T98
O_457	37.1	37.1	617575	4767712	191	951	T93
O_458	36.4	36.4	613699	4764333	185	1024	T08
O_46	33.3	33.4	617608	4753605	180	675	T98
O_460	37.2	37.2	617642	4752002	182	1095	T98

Receptor ID	2015 Results (2015 Amend- ment) Sound Level/ Night	2014 Results (2014 REA Sound Level/ Night	UTM Coordinates (NAD 83, Zone 17)		Z [m]	Distance to the nearest Turbine	Nearest Turbine ID
	dBA	dBA	X [m]	Y [m]			
O_462	32.9	32.9	617645	4767451	190	752	T93
O_463	37.6	37.6	617649	4764887	185	678	T39
O_465	39.2	39.2	617650	4766226	190	729	T97
O_466	38.2	38.2	617667	4753742	180	767	T98
O_468	36.4	36.4	617681	4766893	190	684	T93
O_469	38.3	38.3	613724	4767407	195	1004	T52
O_47	34.3	34.3	617690	4767712	192	863	T93
O_473	36.9	36.9	617694	4769777	195	1465	T94
O_474	33.5	33.5	617694	4766675	190	775	T93
O_475	37.9	37.9	617704	4766234	190	768	T97
O_476	37.9	38.0	617712	4766191	190	741	T97
O_477	38.1	38.1	617721	4753673	180	683	T98
O_478	37.2	37.2	617730	4764887	185	717	T39
O_479	38.9	38.9	617735	4765218	185	671	T97
O_480	38.8	38.8	617736	4755358	180	790	T82
O_481	35.8	35.8	617761	4755244	180	710	T82
O_483	36.6	36.6	617769	4753711	180	701	T98
O_485	37.1	37.1	617775	4766414	190	900	T93
O_486	37.6	37.6	617795	4765735	187	588	T97
O_488	39.1	39.1	617796	4761971	184	1100	T51
O_489	34.9	35.0	613837	4767406	195	953	T52
O_49	34.8	34.8	617801	4751777	183	1279	T98
O_491	32.0	32.0	617805	4761707	182	1306	T51
O_492	33.5	33.6	617810	4763414	185	981	T39
O_493	37.9	37.9	617815	4763472	185	932	T39
O_494	38.0	38.0	617817	4765458	186	630	T97
O_495	38.8	38.8	617830	4766248	190	864	T97
O_499	37.6	37.6	613831	4767480	195	1024	T52
O_50	34.2	34.2	617839	4764776	185	698	T39
O_500	38.9	38.9	617845	4753885	180	853	T98
O_501	36.2	36.2	617866	4755617	180	875	T82
O_503	35.1	35.1	617872	4763481	185	954	T39
O_504	37.9	37.9	617880	4767714	193	736	T93
O_505	37.9	37.9	617899	4751882	183	1163	T98
O_507	32.7	32.7	617900	4762107	185	1090	T51
O_508	35.0	35.0	617908	4763318	185	1035	T07
O_509	37.5	37.5	617910	4768943	195	861	T94
O_511	37.1	37.1	617911	4753884	180	844	T98
O_512	36.4	36.4	617916	4769930	193	1434	T94
O_513	33.7	33.7	617922	4761628	181	1441	T51
O_514	32.8	32.8	617938	4755770	180	967	T82
O_517	34.4	34.4	617940	4768855	195	817	T94
O_518	37.5	37.5	617943	4768435	195	873	T94
O_519	37.4	37.4	613944	4765805	190	774	T52
O_52	38.1	38.2	617950	4768177	195	994	T94
O_521	37.2	37.2	617958	4767627	193	619	T93
O_522	38.9	38.9	617963	4753926	180	884	T98
O_524	36.4	36.4	617967	4768677	195	790	T94
O_525	37.8	37.8	617992	4769931	193	1393	T94
O_528	33.9	33.9	617993	4755630	180	817	T82
O_529	35.7	35.7	617993	4749785	180	1338	T99
O_530	31.7	31.8	618020	4768720	195	734	T94
O_534	38.3	38.3	618025	4768885	195	737	T94
O_535	38.2	38.2	618030	4769124	195	807	T94
O_536	37.6	37.6	618041	4768466	195	771	T94
O_539	38.2	38.2	618043	4749895	180	1345	T99
O_540	31.8	31.8	618043	4768196	195	908	T94
O_541	37.8	37.8	618049	4767696	193	632	T93
O_542	38.9	38.9	618050	4764364	185	663	T07
O_543	39.9	39.9	618055	4766318	190	852	T93
O_544	37.4	37.4	618066	4753981	180	943	T98
O_546	36.4	36.4	618072	4769034	195	732	T94
O_547	38.3	38.3	618075	4763443	185	829	T07
O_548	37.7	37.7	618102	4752438	183	616	T98
O_552	37.6	37.7	618137	4763527	185	725	T07
O_554	38.3	38.3	618140	4756114	180	1225	T82
O_555	33.3	33.3	618143	4754091	180	860	T82
O_556	36.7	36.7	618154	4749537	180	1099	T99
O_557	33.0	33.1	618164	4763414	185	794	T07
O_558	37.7	37.7	618169	4755954	180	1063	T82
O_559	34.1	34.1	614021	4765893	190	666	T52
O_56	39.2	39.3	618199	4749072	180	1020	T99
O_561	33.6	33.6	618214	4756304	180	1400	T82
O_562	32.8	32.8	618220	4769883	191	1200	T85

Receptor ID	2015 Results (2015 Amend- ment) Sound Level/ Night	2014 Results (2014 REA Sound Level/ Night	UTM Coordinates (NAD 83, Zone 17)		Z [m]	Distance to the nearest Turbine	Nearest Turbine ID
	dBA	dBA	X [m]	Y [m]			
O_566	34.9	34.9	618238	4754073	181	855	T82
O_568	36.8	36.8	618245	4748974	180	995	T99
O_569	33.7	33.8	618280	4753947	182	952	T98
O_572	36.6	36.6	618293	4754092	182	828	T82
O_574	36.9	36.9	618296	4750327	180	1431	T99
O_575	31.7	31.8	618297	4763528	185	625	T07
O_576	38.8	38.8	618303	4766248	187	880	T93
O_577	37.0	37.1	618304	4752426	184	696	T98
O_578	36.8	36.8	614085	4765773	190	731	T53
O_58	38.6	38.7	618348	4754124	183	792	T82
O_581	37.1	37.1	618348	4763512	185	612	T07
O_582	38.8	38.8	618351	4752454	185	695	T98
O_583	36.8	36.8	618367	4764837	185	829	T07
O_584	37.6	37.7	618369	4754020	183	895	T82
O_585	36.7	36.7	618402	4756339	180	1424	T82
O_589	33.2	33.2	614091	4767353	195	831	T52
O_59	36.1	36.1	618429	4753408	185	578	T98
O_593	38.7	38.7	618431	4769899	190	1060	T85
O_594	35.6	35.6	618460	4766335	187	803	T93
O_596	37.3	37.3	618470	4754010	184	908	T82
O_598	36.7	36.7	618500	4752601	185	681	T98
O_601	37.1	37.1	618501	4767745	190	643	T93
O_603	39.6	39.6	618524	4748999	180	720	T99
O_606	36.3	36.4	614106	4764244	185	799	T08
O_61	35.4	35.4	618548	4752531	185	764	T98
O_611	36.2	36.3	618577	4750354	181	1294	T99
O_613	32.5	32.6	618596	4753240	185	645	T98
O_614	38.0	38.0	618599	4754260	185	688	T82
O_615	37.8	37.8	618600	4767679	190	617	T93
O_616	39.7	39.7	618611	4764927	185	875	T07
O_617	37.1	37.1	618629	4753322	185	705	T98
O_619	37.5	37.5	618647	4754122	185	834	T82
O_621	36.9	36.9	618653	4769912	190	938	T85
O_622	36.2	36.2	618664	4766334	186	862	T93
O_625	37.0	37.0	618715	4747980	180	1338	T99
O_630	31.9	32.0	618716	4748394	180	964	T99
O_631	34.2	34.2	618742	4750384	181	1251	T99
O_633	32.9	33.0	618744	4752549	185	908	T98
O_635	35.3	35.3	618745	4747868	180	1432	T99
O_636	31.5	31.6	618750	4766286	185	943	T93
O_638	36.6	36.7	618751	4752695	185	844	T98
O_639	35.9	35.9	614260	4767133	192	604	T52
O_64	39.0	39.0	618761	4747824	180	1469	T99
O_644	31.4	31.5	618771	4765711	185	1179	T54
O_648	36.1	36.1	618773	4753790	185	1089	T98
O_649	36.3	36.3	618776	4752856	185	816	T98
O_651	36.3	36.3	618779	4747884	180	1406	T99
O_652	31.7	31.7	618784	4749608	180	572	T99
O_655	38.4	38.4	618788	4747833	180	1452	T99
O_656	31.5	31.6	618790	4750498	182	1341	T99
O_658	32.7	32.7	614355	4767243	192	726	T52
O_66	37.5	37.6	618793	4747800	180	1482	T99
O_660	31.4	31.4	618800	4769997	190	951	T85
O_663	35.9	35.9	618805	4770558	188	1487	T85
O_665	32.2	32.2	618835	4763464	180	622	T07
O_670	38.2	38.2	618855	4763539	181	558	T07
O_674	39.0	39.0	618859	4750473	182	1298	T99
O_676	32.9	32.9	618871	4747948	180	1319	T99
O_680	32.2	32.2	618897	4748136	180	1131	T99
O_683	33.2	33.2	618903	4754436	185	702	T82
O_685	37.9	37.9	618932	4754380	185	761	T82
O_692	37.5	37.5	618934	4767685	190	827	T93
O_694	38.9	38.9	618938	4747969	180	1283	T99
O_696	32.4	32.5	618948	4754449	185	727	T82
O_698	37.7	37.7	618956	4765877	185	1028	T54
O_701	36.4	36.4	618973	4747988	180	1258	T99
O_704	32.6	32.6	618994	4747997	180	1245	T99
O_710	32.7	32.7	619016	4769921	190	822	T85
O_713	36.8	36.8	619017	4747997	180	1241	T99
O_714	32.7	32.8	619049	4754486	185	786	T82
O_716	37.4	37.4	619060	4763065	180	1075	T07
O_717	34.5	34.6	619062	4750221	181	1008	T99
O_718	34.5	34.6	619084	4766349	187	1088	T93
O_720	36.5	36.5	619111	4769990	190	883	T85



Receptor ID	2015 Results (2015 Amend- ment) Sound Level/ Night	2014 Results (2014 REA Sound Level/ Night	UTM Coordinates (NAD 83, Zone 17)		Z [m]	Distance to the nearest Turbine	Nearest Turbine ID
	dBA	dBA	X [m]	Y [m]			
O_722	36.2	36.2	619117	4752583	185	1225	T98
O_723	34.4	34.4	619137	4764895	185	980	T07
O_725	37.0	37.0	619143	4754376	185	926	T82
O_726	37.0	37.0	619161	4752370	185	1357	T98
O_727	33.7	33.7	619168	4769781	190	674	T85
O_729	38.3	38.3	619171	4763444	181	810	T07
O_730	36.3	36.4	619188	4766356	187	1074	T54
O_733	36.5	36.6	619195	4766128	187	920	T54
O_735	36.9	36.9	619206	4750201	181	978	T99
O_736	34.9	35.0	619250	4762961	180	1253	T07
O_739	33.6	33.7	614526	4770053	200	1454	T83
O_74	31.4	31.4	619251	4754532	185	942	T82
O_740	37.0	37.0	619254	4769937	190	838	T85
O_742	36.5	36.6	619288	4756133	180	1254	T19
O_744	36.5	36.6	619302	4750262	181	1043	T99
O_746	34.8	34.8	614546	4764110	185	801	T08
O_75	35.5	35.5	619334	4753549	185	606	T42
O_753	38.6	38.6	619339	4748226	180	1006	T99
O_754	34.6	34.6	619387	4763561	183	898	T07
O_758	35.7	35.8	614564	4770002	200	1445	T83
O_76	31.5	31.5	619390	4766373	188	956	T54
O_760	36.8	36.8	619394	4767799	193	778	T66
O_761	38.2	38.3	619413	4754483	185	1002	T42
O_763	36.9	36.9	619414	4764906	185	868	T54
O_764	37.3	37.4	619424	4749986	180	792	T99
O_765	36.6	36.7	619429	4764966	185	812	T54
O_767	37.6	37.6	619435	4748125	180	1122	T99
O_769	34.1	34.1	614572	4765536	189	626	T08
O_77	39.1	39.2	619436	4750194	181	997	T99
O_770	35.3	35.3	619444	4754555	185	1049	T42
O_772	36.9	36.9	619482	4769933	189	895	T85
O_775	36.0	36.0	619538	4770010	189	988	T85
O_778	35.2	35.2	614580	4770090	200	1390	T83
O_78	31.8	31.8	619552	4754514	185	965	T42
O_780	37.0	37.0	619603	4763499	182	1115	T07
O_783	34.6	34.8	619606	4756798	180	940	T91
O_784	38.0	38.0	619606	4757790	183	1393	T72
O_785	34.9	34.9	619608	4755988	180	905	T19
O_786	38.4	38.4	619638	4767714	192	962	T66
O_789	36.8	36.8	614630	4767094	190	700	T52
O_79	38.4	38.5	619653	4767887	193	829	T66
O_790	37.6	37.6	619666	4763471	182	1183	T07
O_791	34.4	34.5	619681	4754666	185	1069	T42
O_792	37.1	37.1	619694	4750115	180	1016	T99
O_793	35.9	36.0	619701	4756726	180	828	T91
O_795	38.9	38.9	619704	4766408	189	849	T54
O_796	37.3	37.4	619715	4753107	185	565	T42
O_797	38.8	38.8	619717	4770049	187	1106	T85
O_798	34.4	34.4	614645	4764003	185	913	T08
O_80	34.6	34.6	619736	4756077	180	854	T19
O_801	39.3	39.3	619741	4769967	187	1051	T85
O_802	34.8	34.8	619748	4756818	180	812	T91
O_803	39.1	39.1	619757	4748395	181	994	T99
O_805	35.7	35.8	619771	4749883	180	867	T99
O_806	37.1	37.2	619785	4757734	183	1210	T72
O_807	35.9	36.0	619786	4766379	189	801	T54
O_808	37.7	37.7	614678	4770050	200	1322	T83
O_81	32.2	32.2	619803	4767795	193	998	T66
O_811	36.5	36.5	619811	4754551	185	931	T42
O_812	37.3	37.3	619825	4756909	180	782	T91
O_813	39.6	39.6	619862	4754569	185	944	T42
O_817	37.4	37.4	619866	4764992	188	607	T54
O_818	39.3	39.3	619877	4766395	189	804	T54
O_819	37.8	37.8	614687	4766978	190	620	T53
O_82	39.3	39.4	619878	4749607	180	772	T99
O_820	38.5	38.5	619905	4769965	186	1152	T85
O_822	34.2	34.2	619930	4754661	184	966	T19
O_824	37.5	37.5	619952	4757684	183	1040	T72
O_828	37.0	37.1	619969	4766331	188	738	T54
O_829	38.5	38.5	614709	4770220	200	1218	T83
O_83	33.0	33.0	619978	4770050	185	1264	T85
O_831	33.5	33.5	619989	4763509	183	1458	T07
O_832	34.0	34.3	620000	4748356	181	1168	T20
O_834	35.8	35.8	620025	4767858	193	1121	T66

Receptor ID	2015 Results (2015 Amend- ment) Sound Level/ Night	2014 Results (2014 REA Sound Level/ Night	UTM Coordinates (NAD 83, Zone 17)		Z [m]	Distance to the nearest Turbine	Nearest Turbine ID
	dBA	dBA	X [m]	Y [m]			
O_840	35.7	35.8	620035	4763579	183	1478	T07
O_842	34.2	34.4	620036	4770250	185	1455	T85
O_843	32.4	32.4	620038	4752219	185	1413	T42
O_844	34.0	34.0	614752	4765425	189	554	T08
O_85	39.5	39.5	620054	4754545	185	925	T42
O_850	37.6	37.6	620054	4752228	185	1405	T42
O_851	34.0	34.1	620056	4754721	184	858	T19
O_853	37.8	37.8	620065	4752227	185	1407	T42
O_854	34.1	34.1	620072	4749305	181	556	T20
O_856	40.0	40.0	620078	4748520	181	988	T20
O_857	36.5	36.6	620079	4752233	185	1403	T42
O_858	34.1	34.1	620079	4752315	185	1321	T42
O_859	34.2	34.2	614761	4770161	200	1196	T83
O_86	33.1	33.1	620086	4752296	185	1340	T42
O_860	34.2	34.2	620088	4764931	189	679	T54
O_861	38.9	39.0	620093	4752242	185	1395	T42
O_862	34.1	34.1	620093	4752284	185	1353	T42
O_863	34.2	34.2	620105	4752239	185	1400	T42
O_865	34.1	34.1	620106	4752267	185	1372	T42
O_866	34.2	34.2	614772	4770315	200	1123	T83
O_87	33.7	33.7	620120	4752244	185	1397	T42
O_870	34.1	34.2	620132	4770116	185	1417	T85
O_872	32.7	32.7	620136	4768350	195	1024	T66
O_873	36.3	36.3	620137	4768205	195	1060	T66
O_874	36.0	36.0	620153	4767816	193	1249	T66
O_876	35.2	35.2	620169	4752284	185	1364	T42
O_877	34.3	34.3	620173	4752261	185	1387	T42
O_878	34.2	34.3	620181	4748575	182	887	T20
O_879	37.0	37.1	614790	4770195	200	1155	T83
O_88	33.4	33.4	620181	4752372	185	1280	T42
O_880	34.4	34.4	620184	4752360	185	1292	T42
O_881	34.4	34.4	620189	4752345	185	1308	T42
O_882	34.4	34.4	620189	4752292	185	1360	T42
O_883	34.3	34.3	620189	4757633	183	818	T72
O_884	38.7	38.7	620191	4754654	185	883	T19
O_885	37.8	37.8	620195	4752330	185	1324	T42
O_886	34.3	34.4	620200	4752270	185	1384	T42
O_887	34.3	34.3	614826	4771447	196	1063	T88
O_89	34.0	34.0	620216	4752341	185	1318	T42
O_891	34.4	34.4	620223	4752324	185	1335	T42
O_893	34.4	34.4	620230	4752307	185	1353	T42
O_894	34.4	34.4	620239	4752402	185	1263	T42
O_895	34.5	34.5	620242	4752387	185	1279	T42
O_896	34.5	34.5	620244	4752368	185	1297	T42
O_897	34.4	34.5	620249	4752249	185	1415	T42
O_899	34.3	34.3	614834	4770398	199	1037	T83
O_90	34.5	34.5	620250	4752337	185	1329	T42
O_900	34.4	34.4	620255	4752321	185	1346	T42
O_902	34.4	34.4	620259	4752407	185	1263	T42
O_903	34.5	34.6	620270	4752252	185	1416	T42
O_904	34.3	34.4	620278	4757830	184	897	T72
O_906	37.8	37.8	620279	4754728	184	795	T19
O_907	38.2	38.2	620283	4763681	185	1377	T75
O_908	34.6	34.9	620286	4752338	185	1337	T42
O_909	34.4	34.5	614837	4765471	189	632	T08
O_91	38.7	38.7	620288	4752415	185	1263	T42
O_910	34.6	34.6	620291	4752258	185	1416	T42
O_911	34.4	34.4	620292	4752320	185	1355	T42
O_912	34.4	34.5	620302	4752472	185	1213	T42
O_914	34.7	34.7	620312	4752422	185	1263	T42
O_916	34.6	34.6	620316	4752330	185	1352	T42
O_917	34.5	34.5	620316	4752349	185	1334	T42
O_918	34.5	34.5	620321	4752281	185	1401	T42
O_919	34.4	34.5	614845	4771984	195	1340	T88
O_92	31.5	31.5	620322	4752446	185	1244	T42
O_920	34.6	34.7	620323	4752482	185	1210	T42
O_921	34.7	34.7	620324	4763531	183	1433	T74
O_922	34.3	34.7	620325	4766419	188	750	T38
O_923	38.3	38.4	620336	4769979	186	1483	T85
O_924	32.7	32.7	620336	4758057	184	1056	T72
O_925	36.4	36.5	620337	4752435	185	1259	T42
O_926	34.6	34.7	620344	4754837	183	680	T19
O_927	38.9	38.9	620351	4752483	185	1218	T42
O_929	34.7	34.7	620352	4767672	192	1495	T66

Receptor ID	2015 Results (2015 Amend- ment) Sound Level/ Night	2014 Results (2014 REA Sound Level/ Night	UTM Coordinates (NAD 83, Zone 17)		Z [m]	Distance to the nearest Turbine	Nearest Turbine ID
	dBA	dBA	X [m]	Y [m]			
O_930	34.5	34.5	620358	4752433	185	1268	T42
O_931	34.6	34.7	620361	4752290	185	1404	T42
O_932	34.5	34.5	620385	4754933	182	583	T19
O_937	39.8	39.8	614868	4769874	200	1271	T83
O_94	32.6	32.6	620409	4750749	182	1017	T96
O_942	36.8	36.8	620420	4754790	184	727	T19
O_945	38.6	38.6	620425	4752743	185	1011	T42
O_946	35.4	35.4	620427	4758011	184	975	T72
O_947	37.0	37.0	620431	4754854	183	664	T19
O_948	39.1	39.1	620436	4752316	185	1404	T42
O_949	34.6	34.6	614923	4771958	195	1267	T88
O_95	32.0	32.0	620447	4746993	184	1050	T05
O_950	33.7	33.9	620449	4748529	182	832	T20
O_951	37.5	37.6	620457	4752753	185	1019	T42
O_952	35.4	35.4	620466	4754813	184	708	T19
O_955	38.7	38.7	620480	4763593	185	1293	T75
O_957	34.8	35.3	620489	4754832	184	693	T19
O_958	38.8	38.8	620490	4758240	184	1168	T72
O_959	35.6	35.7	614958	4770714	195	863	T83
O_96	36.5	36.5	620510	4748556	182	794	T20
O_963	37.8	37.9	620529	4750602	181	896	T96
O_965	37.6	37.7	620540	4752389	185	1379	T42
O_968	34.8	34.8	620548	4752823	185	1012	T42
O_969	35.5	35.5	614969	4763936	185	1064	T08
O_97	33.9	33.9	620551	4747071	185	922	T05
O_971	34.7	34.8	620562	4752314	185	1456	T42
O_973	34.8	34.8	620571	4752590	185	1217	T42
O_975	34.9	35.0	614983	4770652	195	840	T83
O_98	36.6	36.6	620617	4748743	182	599	T20
O_980	39.2	39.3	620635	4751902	185	1306	T63
O_981	35.6	35.6	620638	4766431	188	680	T38
O_983	38.4	38.4	620640	4763545	185	1151	T74
O_984	35.2	35.7	620647	4766310	187	559	T38
O_986	39.7	39.8	620682	4746999	185	899	T05
O_989	34.9	35.0	614996	4771180	195	829	T88
O_99	36.6	36.6	620698	4752728	185	1180	T42
O_994	35.1	35.2	620721	4765017	185	737	T38
P_1004	39.6	39.7	620777	4750321	180	733	T96
P_1039	39.1	39.1	621195	4765046	185	529	T75
P_1191	40.5	40.6	621355	4764993	185	451	T75
P_1235	41.3	41.3	621405	4747101	188	694	T05
P_1255	37.3	37.5	621564	4763692	185	695	T74
P_1275	38.4	39.2	621621	4753094	185	916	T84
P_1283	36.7	36.7	621674	4755402	181	767	T13
P_1293	39.3	39.4	621726	4755431	181	760	T13
P_1300	39.3	39.4	621819	4748739	183	725	T47
P_1322	38.7	39.5	621991	4761415	180	1000	T95
P_1375	38.6	39.3	622096	4755479	180	940	T13
P_1429	38.2	38.5	622322	4763635	180	575	T36
P_1523	38.6	39.3	622432	4761563	179	810	T95
P_1554	37.8	38.0	622470	4763422	180	370	T36
P_1562	41.0	41.5	622501	4751591	182	685	T62
P_1567	38.9	39.0	622599	4767952	193	759	T27
P_1584	38.9	38.9	622733	4754331	180	429	T65
P_1610	42.6	42.7	622739	4761436	181	590	T95
P_1613	38.6	38.7	622961	4754427	180	253	T65
P_1666	46.0	46.0	623038	4765135	185	612	T01
P_1688	40.3	40.6	623062	4766552	190	694	T06
P_1690	39.8	39.9	623101	4755153	182	488	T65
P_1703	41.7	41.7	623121	4765056	185	702	T01
P_1711	39.9	40.3	623171	4759596	180	613	T10
P_1727	39.9	39.9	623422	4765171	185	590	T76
P_1765	41.0	41.4	623736	4765098	185	629	T76
P_1846	40.5	41.0	623749	4763990	180	427	T55
P_1848	40.0	41.5	623844	4765184	185	573	T76
P_1872	40.7	41.0	615738	4771386	191	336	T88
P_191	43.4	43.4	615823	4771824	190	765	T88
P_197	36.5	36.5	624061	4765197	185	671	T76
P_1981	39.9	40.2	624118	4753544	185	980	T89
P_1994	35.6	35.3	624194	4753418	185	1011	T89
P_2030	35.2	35.0	624395	4768064	190	634	T57
P_2084	38.3	38.3	624454	4750143	180	892	T48
P_2090	39.1	39.2	624792	4763832	183	578	T32
P_2165	38.9	39.2	616142	4767556	190	622	T81

Receptor ID	2015 Results (2015 Amend- ment) Sound Level/ Night	2014 Results (2014 REA Sound Level/ Night	UTM Coordinates (NAD 83, Zone 17)		Z [m]	Distance to the nearest Turbine	Nearest Turbine ID
	dBA	dBA	X [m]	Y [m]			
P_225	37.9	38.0	625016	4768416	190	644	T57
P_2250	37.9	38.0	625246	4765256	185	573	T31
P_2293	40.0	40.2	625758	4747261	185	917	T61
P_2359	37.3	37.3	626407	4769228	190	446	T56
P_2529	40.5	40.5	626570	4763961	185	636	T34
P_2544	38.8	39.7	626634	4765414	186	632	T33
P_2548	39.9	40.9	626653	4765264	185	693	T34
P_2579	42.6	43.8	626952	4765571	188	380	T33
P_2587	40.2	40.7	626995	4763978	185	533	T35
P_2590	45.1	45.4	627015	4764720	185	280	T35
P_2614	40.7	41.4	627178	4765280	190	693	T02
P_2636	40.4	40.6	627349	4764012	185	506	T35
P_2640	41.0	41.1	627377	4748490	180	510	T23
P_2675	39.3	39.3	627582	4748380	180	596	T23
P_2768	39.7	39.8	628268	4768175	190	583	T58
P_2810	39.4	39.6	628355	4765347	189	607	T78
P_2855	38.4	38.5	628527	4763886	185	786	T29
P_2893	38.6	38.7	628615	4764042	185	742	T78
P_2914	39.0	39.2	628670	4768195	190	599	T58
P_2939	37.4	37.5	628752	4762502	180	650	T29
P_3028	39.4	39.8	629305	4767498	185	683	T59
P_313	39.7	39.7	616826	4763379	185	657	T51
P_3140	36.9	36.9	629869	4772625	185	715	T80
P_3151	40.0	40.0	630039	4764044	185	480	T03
P_3160	39.1	40.4	630165	4766791	190	564	T18
P_3171	39.3	40.3	630312	4768255	188	574	T60
P_3210	34.7	34.7	630878	4772668	180	973	T80
P_345	40.0	40.0	617016	4763383	185	631	T51
P_3708	39.6	39.8	624914	4763900	185	527	T32
P_3708	39.6	39.8	624914	4763900	185	527	T32
P_382	39.6	39.6	617180	4766206	189	566	T97
P_3893	41.7	41.7	627693	4749818	180	425	T24
P_3894	38.9	39.5	622029	4749158	182	733	T46
P_3895	38.4	38.4	622621	4751424	182	753	T62
P_3897	42.0	42.1	627442	4768130	190	398	T04
P_3902	38.5	38.5	614181	4767160	193	630	T52
P_411	40.4	40.4	617317	4763230	185	563	T51
P_439	40.3	40.3	617463	4764813	185	546	T39
P_461	39.7	39.7	617609	4764824	185	604	T39
P_567	37.9	37.9	618224	4752489	184	604	T98
P_580	40.1	40.1	618345	4767663	190	537	T93
P_590	37.5	37.5	618408	4752569	185	637	T98
P_595	44.7	44.7	618453	4768755	195	299	T94
P_642	38.3	38.3	618759	4754396	185	637	T82
P_67	39.4	39.5	614393	4765788	190	618	T53
P_689	44.1	44.1	618924	4764034	185	289	T07
P_690	38.9	39.0	618929	4763574	181	562	T07
P_703	39.1	39.1	618972	4767763	191	781	T66
P_72	39.1	39.1	614498	4765557	190	648	T08
P_743	38.7	38.7	619257	4767798	192	743	T66
P_757	36.9	36.9	619378	4754477	185	1015	T42
P_815	39.4	39.4	619830	4756972	180	811	T91
P_816	39.5	39.6	619841	4765022	188	581	T54
P_827	38.9	38.9	619941	4749526	180	711	T20
P_839	39.5	39.5	620023	4757321	182	829	T72
P_848	39.6	39.6	620050	4749472	181	592	T20
P_939	39.1	39.2	620400	4766345	187	651	T38
P_960	40.0	40.0	620500	4754958	183	571	T19
V_104	39.4	39.4	614831	4765389	188	557	T08
V_1041	35.8	36.4	620779	4763617	185	1070	T74
V_1052	35.8	36.4	620802	4763561	185	1021	T74
V_1057	39.1	39.1	620810	4750114	180	794	T20
V_1067	35.9	35.9	620840	4758277	185	1155	T72
V_1071	36.4	36.4	620845	4754148	185	1048	T42
V_110	33.7	33.7	615144	4769829	200	1115	T83
V_1100	35.9	36.0	620903	4747004	186	796	T05
V_1102	36.7	36.8	620907	4747084	186	720	T05
V_1108	39.7	39.7	620934	4755121	183	681	T19
V_1110	36.1	36.2	620939	4753991	185	1068	T42
V_1120	36.2	36.3	620968	4758224	185	1111	T72
V_1121	37.5	37.6	620969	4766447	188	757	T38
V_1122	39.7	39.8	620971	4749867	180	628	T20
V_1124	38.8	38.9	620978	4748746	182	691	T20
V_1162	38.6	38.8	621095	4748789	182	724	T20

Receptor ID	2015 Results (2015 Amend- ment) Sound Level/ Night	2014 Results (2014 REA Sound Level/ Night	UTM Coordinates (NAD 83, Zone 17)		Z [m]	Distance to the nearest Turbine	Nearest Turbine ID
	dBA	dBA	X [m]	Y [m]			
V_1189	36.9	37.0	621193	4758095	184	1040	T72
V_1190	38.4	38.4	621193	4751834	183	861	T62
V_1195	35.8	35.8	621203	4753582	185	1268	T42
V_1210	34.8	35.5	621249	4762014	185	1069	T74
V_1219	35.8	35.9	621277	4753727	185	1255	T84
V_1230	38.0	38.9	621316	4763588	185	677	T74
V_1236	38.6	38.6	621357	4755146	183	978	T13
V_1243	35.7	35.7	621369	4758305	185	1301	T72
V_1251	36.4	36.6	621399	4747003	188	785	T05
V_1261	38.0	38.0	621434	4757850	183	947	T72
V_1267	34.2	34.5	621502	4761141	181	1346	T95
V_1268	33.2	33.4	621523	4760546	185	1329	T95
V_1270	33.1	33.2	621530	4760438	185	1352	T95
V_1272	39.5	39.7	621547	4755384	182	751	T13
V_1274	33.1	33.1	621552	4769986	188	1313	T28
V_1276	38.8	38.9	621570	4755267	182	870	T13
V_1281	38.9	38.9	621593	4757604	182	904	T72
V_1285	35.3	35.3	621628	4769559	186	1002	T28
V_1289	38.2	38.3	621646	4757675	182	987	T72
V_1295	36.9	37.0	621694	4753007	185	881	T84
V_1301	33.7	33.8	621735	4759605	182	1491	T37
V_1303	35.3	35.5	621740	4761101	183	1105	T95
V_1304	39.4	39.4	621743	4757353	181	898	T41
V_1308	35.9	36.2	621755	4747019	189	939	T05
V_1309	33.1	33.2	621757	4770099	189	1259	T28
V_1318	35.9	36.0	621804	4766414	189	1314	T38
V_1324	38.3	38.4	621825	4757476	181	1037	T41
V_1331	37.9	37.9	621852	4757544	181	1100	T41
V_1333	36.2	36.5	621857	4761186	181	1016	T95
V_1343	34.9	35.1	621908	4746516	189	1441	T05
V_1352	35.9	36.0	621926	4766561	190	1337	T01
V_1354	39.4	39.6	621934	4755632	180	717	T13
V_1361	33.3	33.4	621956	4770161	190	1203	T28
V_1364	37.4	37.6	621966	4765351	185	1013	T75
V_1385	38.4	38.9	622014	4749325	182	807	T46
V_1386	37.5	37.6	622014	4769614	186	722	T28
V_1389	37.2	37.2	622032	4752446	184	1051	T84
V_1414	35.2	35.3	622079	4759548	183	1168	T37
V_1424	38.5	39.1	622087	4749360	182	759	T46
V_1435	38.6	38.6	622101	4756932	180	1065	T13
V_1436	37.7	37.9	622102	4764951	185	850	T75
V_1443	37.5	37.7	622114	4761205	181	787	T95
V_1452	38.9	38.9	622129	4753983	182	691	T84
V_1462	37.7	38.4	622150	4763812	180	783	T36
V_1463	38.4	38.4	622150	4769623	185	642	T28
V_1473	35.6	35.6	622184	4759623	180	1132	T37
V_1475	36.9	36.9	622185	4759011	181	863	T37
V_1480	38.1	38.1	622196	4760773	185	625	T95
V_1482	37.6	37.7	622200	4760616	185	659	T95
V_1483	37.0	37.0	622205	4760457	185	728	T95
V_1484	36.5	36.6	622205	4760364	185	782	T95
V_1485	36.1	36.1	622205	4760252	184	856	T95
V_1486	36.3	36.3	622207	4760296	184	824	T95
V_1488	35.8	35.9	622209	4760180	183	905	T95
V_1490	35.6	35.7	622211	4760102	183	964	T95
V_1493	35.5	35.6	622215	4760015	182	1030	T95
V_1496	35.4	35.5	622220	4759930	181	1098	T95
V_1498	38.1	38.2	622231	4761225	180	695	T95
V_1499	36.8	36.8	622232	4757310	180	1317	T41
V_1506	38.2	38.2	622255	4755623	181	982	T13
V_1510	37.0	37.1	622278	4766506	190	1039	T01
V_1516	39.1	39.1	622296	4754165	180	795	T84
V_1517	37.9	37.9	622298	4752046	183	847	T62
V_1519	34.3	34.4	622304	4770121	190	1047	T28
V_1520	38.5	38.5	622310	4751917	183	744	T62
V_1531	37.3	37.4	622348	4766512	190	998	T01
V_1536	36.7	36.7	622366	4759563	180	958	T37
V_1545	38.0	38.0	622398	4755588	181	1082	T65
V_1548	39.0	39.0	622425	4751713	182	679	T62
V_155	32.2	32.3	615358	4762588	185	1432	T09
V_1550	35.8	35.8	622428	4757584	180	1434	T37
V_1565	33.2	33.2	622495	4770305	190	1210	T28
V_1566	38.3	38.4	622498	4751743	182	757	T62
V_1568	37.4	37.4	622508	4755790	183	1147	T13



Receptor ID	2015 Results (2015 Amend- ment) Sound Level/ Night	2014 Results (2014 REA Sound Level/ Night	UTM Coordinates (NAD 83, Zone 17)		Z [m]	Distance to the nearest Turbine	Nearest Turbine ID
	dBA	dBA	X [m]	Y [m]			
V_1573	36.4	36.9	622543	4762185	180	894	T36
V_1578	36.3	36.7	622586	4762187	180	901	T36
V_1581	38.5	38.7	622588	4747070	185	1381	T47
V_1582	38.7	38.7	622589	4767849	193	789	T06
V_1587	38.1	38.7	622606	4762550	180	561	T36
V_1589	37.7	38.2	622621	4762509	180	605	T36
V_1590	39.1	39.2	622624	4761373	182	556	T95
V_1591	37.6	37.6	622632	4759683	181	899	T37
V_1592	36.1	36.6	622632	4762187	180	912	T36
V_1593	37.5	38.1	622640	4763709	180	696	T36
V_1595	38.1	38.6	622649	4762580	180	554	T36
V_1598	38.7	38.7	622666	4766527	190	836	T06
V_1599	37.4	37.9	622667	4762496	180	636	T36
V_1601	36.0	36.4	622670	4762187	180	923	T36
V_1604	37.7	38.2	622695	4762561	180	594	T36
V_1606	35.9	36.3	622708	4762189	180	934	T36
V_1607	37.2	37.7	622709	4762499	180	654	T36
V_1612	37.3	37.8	622737	4762539	180	635	T36
V_1616	36.9	37.4	622747	4762488	180	683	T36
V_1618	35.7	36.2	622755	4762191	180	950	T36
V_1620	37.0	37.4	622780	4762530	180	667	T36
V_1622	36.6	37.1	622792	4762474	180	720	T36
V_1625	35.6	36.0	622800	4762197	180	963	T36
V_1629	36.6	37.1	622823	4762514	180	706	T36
V_1630	38.1	38.9	622823	4747628	185	887	T47
V_1631	37.8	37.9	622825	4761513	180	662	T95
V_1635	36.2	36.7	622841	4762453	180	765	T36
V_1639	37.0	37.1	622853	4751164	181	988	T62
V_1640	36.3	36.8	622862	4762497	180	744	T36
V_1644	35.9	36.3	622886	4762421	180	818	T36
V_1648	36.0	36.5	622902	4762474	180	788	T36
V_1650	35.3	35.7	622911	4762211	180	1005	T36
V_1652	35.6	36.0	622917	4762374	180	874	T36
V_1653	38.6	38.7	622920	4759684	181	772	T10
V_1654	35.4	35.8	622925	4762306	180	934	T36
V_1655	34.8	34.8	622926	4757514	180	1372	T37
V_1659	33.8	33.9	622939	4770159	190	1144	T28
V_1660	35.7	36.2	622939	4762441	180	837	T36
V_1661	40.0	40.0	622945	4758310	180	579	T37
V_1665	35.5	35.9	622958	4762404	180	878	T36
V_1667	35.0	35.0	622961	4757598	180	1285	T37
V_1669	35.1	35.5	622968	4762245	180	1008	T36
V_1670	35.2	35.7	622969	4762316	180	952	T36
V_1671	35.3	35.8	622972	4762365	180	916	T36
V_1673	35.0	35.4	622974	4762174	180	1070	T36
V_1676	36.5	36.6	622983	4750853	180	1198	T62
V_168	32.1	32.1	615464	4762174	185	1386	T09
V_1684	39.1	39.2	623027	4752564	184	626	T89
V_1689	35.8	35.8	623059	4755875	184	1198	T65
V_1692	39.6	39.6	623068	4758264	180	618	T37
V_1693	38.5	38.5	623069	4760288	183	617	T95
V_1698	37.0	37.0	623074	4769670	187	800	T28
V_1699	37.6	37.6	623077	4760135	183	761	T95
V_1709	37.4	37.4	623109	4759967	182	931	T95
V_1716	38.5	38.5	623130	4759737	181	758	T10
V_1724	37.5	37.5	623166	4760181	183	756	T95
V_1728	36.3	36.4	623172	4761561	180	794	T95
V_1736	35.7	36.3	623245	4763115	181	868	T36
V_1737	32.7	32.7	623247	4770258	190	1373	T28
V_1739	33.1	33.1	623259	4770177	189	1312	T28
V_1740	35.7	36.3	623260	4763182	181	889	T36
V_1745	35.2	35.3	623317	4751215	181	1444	T62
V_1747	35.2	35.8	623329	4763033	180	951	T36
V_1749	33.9	34.4	623333	4762292	180	1227	T36
V_1752	37.3	38.4	623344	4763761	184	686	T55
V_1753	34.4	34.4	623349	4757624	180	1295	T37
V_1755	35.0	35.2	623360	4761626	180	946	T95
V_1759	39.1	39.4	623378	4747182	185	1484	T45
V_1762	37.9	37.9	623417	4768353	193	952	T27
V_1763	34.7	35.3	623418	4762970	180	1044	T36
V_177	36.1	36.1	615576	4766159	189	1114	T81
V_1771	39.5	39.5	623450	4766553	190	777	T06
V_1773	34.5	35.1	623454	4762934	180	1083	T36
V_1778	34.3	34.9	623489	4762879	180	1125	T36

Receptor ID	2015 Results (2015 Amend- ment) Sound Level/ Night	2014 Results (2014 REA Sound Level/ Night	UTM Coordinates (NAD 83, Zone 17)		Z [m]	Distance to the nearest Turbine	Nearest Turbine ID
	dBA	dBA	X [m]	Y [m]			
V_1779	32.6	32.6	623489	4770192	190	1466	T28
V_1785	37.6	37.8	623506	4750154	180	1117	T16
V_1791	34.9	35.6	623527	4763179	181	1155	T36
V_1799	38.7	38.9	623552	4749960	180	936	T16
V_1840	37.4	37.5	623700	4768015	191	979	T06
V_1845	33.5	33.6	623722	4757626	180	1429	T37
V_1847	34.1	34.1	623739	4755564	180	1164	T65
V_1849	38.0	38.0	623769	4758446	180	745	T10
V_1856	37.9	38.0	623812	4752888	185	655	T89
V_1868	32.6	32.9	623837	4761892	180	1458	T95
V_1876	37.7	37.7	623848	4758506	180	762	T10
V_1882	33.9	34.0	623858	4761052	180	1060	T95
V_1895	37.2	37.3	623893	4767932	190	937	T57
V_1898	33.4	33.4	623897	4755576	180	1281	T65
V_1902	34.3	34.4	623905	4760164	180	1287	T95
V_1919	32.8	33.0	623943	4761474	180	1287	T95
V_192	35.2	35.2	615747	4769791	199	927	T83
V_1929	35.4	35.5	623964	4759698	180	999	T10
V_1933	33.1	33.3	623969	4761177	180	1198	T95
V_1935	33.0	33.0	623970	4755588	180	1341	T65
V_1937	33.3	33.3	623971	4755503	180	1285	T65
V_1942	33.9	33.9	623979	4755268	180	1156	T65
V_1951	37.5	37.6	623996	4768037	190	792	T57
V_1957	34.1	34.3	624007	4760011	180	1266	T10
V_1960	36.0	35.8	624016	4753703	185	967	T89
V_1964	35.3	35.4	624026	4759635	180	1002	T10
V_1975	35.9	35.7	624046	4753656	185	966	T89
V_1995	39.7	40.0	624119	4765202	185	705	T76
V_2000	34.5	34.6	624147	4759649	180	1105	T10
V_2033	38.0	38.0	624200	4768053	190	685	T57
V_205	35.2	35.2	615932	4763336	185	1146	T09
V_2055	33.9	34.0	624254	4759649	180	1194	T10
V_2065	34.5	34.3	624307	4753245	185	1094	T89
V_208	32.8	32.8	615962	4769375	200	1347	T83
V_2082	34.0	33.8	624378	4753524	185	1218	T89
V_2103	36.5	36.6	624554	4750520	180	1244	T48
V_2104	32.8	32.9	624567	4759129	180	1315	T10
V_2127	32.0	32.1	624689	4758735	180	1452	T10
V_2129	31.9	32.0	624691	4758627	180	1477	T10
V_214	34.8	34.9	616008	4764767	185	1427	T39
V_2162	36.7	36.8	624788	4767981	190	798	T57
V_2164	36.9	37.0	624791	4766635	190	890	T31
V_217	36.7	36.7	616033	4767628	191	729	T81
V_2180	39.8	40.0	624850	4765241	185	653	T31
V_2182	34.7	34.8	624853	4746530	185	1476	T61
V_2207	35.3	35.4	624925	4746685	185	1309	T61
V_2232	34.9	35.0	624981	4746600	185	1384	T61
V_2240	34.8	34.8	624993	4746581	185	1402	T61
V_2252	32.2	32.3	625021	4769945	185	1380	T57
V_2259	34.7	34.8	625044	4746581	185	1396	T61
V_2262	34.6	34.7	625057	4746559	185	1416	T61
V_2264	34.2	34.3	625063	4746485	180	1489	T61
V_2276	34.3	34.4	625119	4746522	180	1450	T61
V_2277	34.0	34.1	625139	4769530	190	1091	T57
V_2279	34.4	34.5	625153	4746547	180	1423	T61
V_2284	34.5	34.6	625203	4746576	180	1394	T61
V_2287	34.5	34.6	625224	4746586	180	1385	T61
V_2288	37.1	37.1	625229	4747002	185	970	T61
V_2291	34.5	34.6	625244	4746595	181	1377	T61
V_2294	34.5	34.6	625253	4746601	181	1371	T61
V_2296	34.5	34.6	625264	4746606	181	1367	T61
V_2305	34.6	34.7	625346	4746645	181	1335	T61
V_2307	35.0	35.1	625372	4767998	190	1169	T57
V_2308	35.3	35.4	625381	4750522	180	1420	T48
V_2317	35.7	35.8	625440	4746864	180	1137	T61
V_2319	36.0	36.1	625448	4746909	180	1095	T61
V_2321	37.0	37.2	625457	4766589	190	827	T31
V_2323	36.2	36.3	625477	4746957	180	1057	T61
V_2328	35.3	35.8	625502	4763629	182	1063	T32
V_2329	36.5	36.5	625505	4747000	180	1024	T61
V_2336	36.9	36.9	625564	4750098	180	1198	T48
V_2339	38.6	39.0	625581	4765192	190	762	T31
V_2340	38.1	38.1	625588	4749828	180	1053	T48
V_2342	36.3	36.6	625601	4766665	190	957	T31

Receptor ID	2015 Results (2015 Amend- ment) Sound Level/ Night	2014 Results (2014 REA Sound Level/ Night	UTM Coordinates (NAD 83, Zone 17)		Z [m]	Distance to the nearest Turbine	Nearest Turbine ID
	dBA	dBA	X [m]	Y [m]			
V 2345	36.7	36.8	625627	4747097	180	982	T61
V 2347	36.8	36.8	625644	4747112	180	977	T61
V 2348	38.6	38.6	625657	4749645	180	1036	T48
V 2361	39.9	39.9	625768	4749138	180	971	T43
V 2363	38.9	38.9	625774	4747519	185	749	T61
V 2364	38.3	39.2	625776	4764704	185	719	T34
V 2371	39.4	39.4	625796	4747633	185	705	T61
V 2372	38.6	38.6	625797	4749519	180	1134	T43
V 2380	37.3	38.2	625830	4764146	184	792	T34
V 2391	36.9	37.0	625852	4747279	181	966	T61
V 2395	37.0	37.0	625863	4747290	181	966	T61
V 2397	37.7	37.7	625864	4747417	185	882	T61
V 2399	36.9	37.0	625873	4768936	190	735	T56
V 2404	39.6	39.6	625886	4749083	180	965	T49
V 2410	37.0	37.0	625901	4747325	180	969	T61
V 2411	39.7	39.7	625905	4748999	180	934	T49
V 2414	37.0	37.0	625913	4747339	180	969	T61
V 2422	34.3	34.4	625939	4769572	188	997	T56
V 2427	37.1	37.2	625953	4747404	184	960	T61
V 2428	37.0	37.0	625954	4747376	180	978	T61
V 2429	37.1	37.2	625967	4747415	183	965	T61
V 2430	37.0	37.0	625968	4747385	180	984	T61
V 2433	36.9	37.0	625982	4747394	180	990	T61
V 2435	36.2	36.7	625984	4766616	190	1153	T31
V 2437	39.7	39.8	625994	4748823	180	847	T49
V 2438	36.9	37.0	625997	4747405	180	996	T61
V 2442	36.9	36.9	626015	4747412	180	1007	T61
V 2444	36.8	36.9	626027	4747420	180	1012	T61
V 2447	36.8	36.8	626047	4747434	180	1022	T61
V 2451	39.7	39.7	626075	4748689	180	794	T49
V 2452	36.7	36.8	626078	4747452	180	1039	T61
V 2455	36.7	36.7	626094	4747463	180	1048	T61
V 2456	38.9	38.9	626095	4749275	180	823	T49
V 2458	37.0	37.0	626100	4747535	183	1020	T61
V 2459	36.7	36.7	626110	4747474	180	1057	T61
V 2461	36.7	36.7	626123	4747484	180	1063	T61
V 2464	36.6	36.7	626139	4747496	180	1073	T61
V 2466	35.3	35.6	626146	4767665	190	1245	T56
V 2467	36.8	36.8	626146	4747542	181	1059	T61
V 2470	36.6	36.6	626155	4747507	180	1082	T61
V 2473	36.8	36.8	626169	4747565	181	1071	T61
V 2480	39.1	39.1	626208	4748353	180	842	T49
V 2488	36.7	36.7	626249	4747641	181	1121	T61
V 2494	38.7	38.7	626263	4748246	180	881	T49
V 2495	36.7	36.8	626264	4747660	181	1130	T61
V 2505	38.2	38.3	626298	4748134	180	948	T49
V 2508	39.0	39.0	626300	4749376	180	707	T49
V 2551	37.2	37.3	626664	4769482	190	661	T56
V 2561	37.7	38.4	626760	4766764	190	840	T33
V 2563	36.9	37.0	626766	4769489	190	685	T56
V 2565	38.0	38.6	626859	4766770	190	827	T33
V 2577	39.5	39.6	626931	4748310	180	613	T49
V 2581	33.1	33.2	626957	4751172	180	1227	T24
V 2592	39.0	39.1	627021	4749700	180	806	T49
V 2597	38.2	38.3	627046	4769223	190	598	T56
V 2625	33.0	33.1	627266	4751300	180	1167	T24
V 2630	34.2	34.5	627294	4762944	180	1214	T29
V 2635	40.0	40.0	627347	4749801	180	597	T24
V 2642	35.5	35.6	627383	4769262	190	897	T56
V 2648	34.7	34.8	627420	4751093	180	917	T24
V 2654	37.0	37.3	627452	4763625	182	906	T35
V 2655	38.9	38.9	627457	4748315	180	664	T23
V 2661	34.4	34.5	627512	4769358	190	1057	T56
V 2669	33.8	33.9	627564	4769455	190	1152	T56
V 2678	31.4	31.4	627611	4751640	180	1409	T24
V 2684	37.2	37.5	627659	4763662	183	959	T35
V 2685	38.5	38.9	627663	4766786	190	890	T02
V 2705	39.7	39.7	627870	4768233	190	603	T04
V 2714	38.1	38.5	627919	4766710	190	938	T02
V 2719	40.0	40.0	627958	4749727	180	552	T24
V 2732	37.1	37.1	628019	4748409	183	741	T23
V 2736	38.6	38.7	628044	4762768	181	562	T29
V 2738	38.9	39.2	628067	4765420	190	819	T78
V 2747	31.0	31.2	628154	4761763	172	1381	T29

Receptor ID	2015 Results (2015 Amend- ment) Sound Level/ Night	2014 Results (2014 REA Sound Level/ Night	UTM Coordinates (NAD 83, Zone 17)		Z [m]	Distance to the nearest Turbine	Nearest Turbine ID
	dBA	dBA	X [m]	Y [m]			
V 2754	39.1	39.2	628211	4768233	190	659	T58
V 2763	39.1	39.2	628252	4768237	190	647	T58
V 277	33.1	33.1	616538	4771946	193	1144	T88
V 2777	38.4	38.5	628295	4764039	185	797	T78
V 2778	37.5	37.5	628297	4749736	180	741	T24
V 2779	39.1	39.2	628297	4768243	190	639	T58
V 2790	38.4	38.5	628332	4763843	185	761	T29
V 2792	33.5	33.7	628333	4769115	186	1492	T58
V 2793	33.7	33.9	628333	4769078	186	1455	T58
V 2795	33.8	34.0	628335	4769042	187	1419	T58
V 2796	34.2	34.4	628337	4768962	188	1340	T58
V 2797	34.0	34.2	628338	4769002	188	1380	T58
V 2798	35.0	35.1	628339	4768802	190	1181	T58
V 2799	31.3	31.5	628340	4761775	172	1335	T29
V 2800	34.4	34.6	628341	4768908	189	1286	T58
V 2801	34.7	34.9	628341	4768857	190	1235	T58
V 2802	32.7	32.7	628341	4751223	180	1147	T24
V 2803	35.3	35.4	628342	4768748	190	1127	T58
V 2805	35.5	35.7	628345	4768698	190	1077	T58
V 2807	36.1	36.3	628349	4768607	190	985	T58
V 2808	35.9	36.0	628350	4768645	190	1023	T58
V 2809	36.6	36.7	628353	4768532	190	911	T58
V 2811	36.9	37.0	628355	4768495	190	874	T58
V 2812	37.2	37.3	628355	4768454	190	834	T58
V 2813	36.3	36.5	628356	4768571	190	949	T58
V 2814	37.5	37.6	628358	4768416	190	795	T58
V 2815	35.9	35.9	628358	4750714	180	770	T24
V 2816	37.7	37.9	628360	4768382	190	761	T58
V 2817	39.1	39.2	628361	4768243	190	624	T58
V 2818	38.4	38.5	628363	4768305	190	685	T58
V 2819	38.1	38.2	628364	4768346	190	725	T58
V 2820	36.4	36.4	628376	4749501	180	966	T24
V 2825	32.8	32.8	628407	4748020	183	1289	T23
V 283	30.3	30.3	616635	4752407	180	1489	T98
V 2830	38.4	38.5	628442	4768304	190	675	T58
V 2836	35.6	35.6	628470	4749149	181	947	T23
V 2839	31.5	31.6	628502	4761766	180	1335	T29
V 286	38.5	38.5	616651	4766283	189	750	T81
V 287	31.2	31.2	616652	4753170	180	1336	T98
V 2953	32.6	32.6	628828	4750787	180	1207	T24
V 2958	33.5	33.5	628872	4749845	180	1187	T24
V 2966	38.0	38.1	628932	4763973	185	883	T78
V 2969	36.0	36.0	628980	4762465	180	797	T29
V 2970	32.2	32.3	629010	4771209	190	1408	T80
V 2971	37.3	37.5	629011	4768268	186	835	T58
V 2975	31.5	31.5	629032	4750901	180	1441	T24
V 2980	32.5	32.5	629064	4749852	180	1368	T24
V 299	31.7	31.7	616733	4753247	180	1265	T98
V 2990	32.3	32.3	629108	4749771	181	1434	T24
V 3019	39.2	39.5	629255	4767813	185	722	T59
V 303	31.9	31.9	616766	4753266	180	1236	T98
V 3038	38.6	38.7	629349	4763961	185	658	T03
V 3042	38.9	39.0	629354	4763899	185	621	T03
V 3045	32.0	32.1	629355	4762034	183	1368	T29
V 3052	32.3	32.4	629377	4770692	189	1381	T79
V 3054	39.3	39.3	629378	4763305	185	586	T03
V 3059	36.8	37.9	629385	4766314	189	742	T18
V 3070	36.8	36.9	629398	4762870	185	871	T03
V 3089	38.6	38.7	629420	4764026	185	644	T03
V 3096	38.1	38.2	629471	4764140	185	694	T03
V 3104	33.5	33.6	629510	4762372	182	1246	T29
V 3121	38.4	38.5	629605	4764154	185	635	T03
V 3129	38.5	39.4	629661	4766963	189	774	T59
V 3131	33.2	33.3	629672	4762372	181	1235	T03
V 3137	38.7	38.8	629776	4764164	185	588	T03
V 3139	39.1	39.1	629843	4771318	185	628	T79
V 3142	39.8	39.8	629916	4771316	185	567	T79
V 3148	36.7	36.8	630019	4764335	185	759	T03
V 3152	34.1	34.2	630041	4770645	185	1049	T79
V 3165	34.4	34.5	630225	4770651	185	998	T79
V 3170	35.5	36.8	630304	4765510	190	741	T18
V 3177	34.5	34.8	630393	4764440	188	989	T03
V 3185	36.8	36.9	630471	4772665	176	739	T80
V 3190	37.8	39.2	630505	4766725	190	627	T18

Receptor ID	2015 Results (2015 Amend- ment) Sound Level/ Night	2014 Results (2014 REA Sound Level/ Night	UTM Coordinates (NAD 83, Zone 17)		Z [m]	Distance to the nearest Turbine	Nearest Turbine ID
	dBA	dBA	X [m]	Y [m]			
V_3199	36.1	36.1	630648	4772658	180	818	T80
V_3201	33.9	35.2	630692	4765529	190	902	T18
V_3203	34.2	34.3	630720	4764061	187	954	T03
V_3205	36.6	37.8	630765	4767001	190	838	T60
V_322	32.0	32.0	616904	4753814	180	1325	T98
V_3226	37.7	37.7	631065	4771610	182	681	T79
V_3251	34.2	35.3	631220	4767803	185	950	T60
V_330	31.3	31.3	616939	4752260	180	1304	T98
V_337	31.8	31.8	616974	4752356	180	1219	T98
V_355	32.2	32.3	617052	4754168	180	1460	T98
V_3581	37.5	37.5	617952	4766319	190	890	T93
V_3582	39.8	39.8	618166	4767657	192	553	T93
V_3583	39.6	39.6	618075	4767629	193	561	T93
V_3598	33.7	33.7	629463	4772699	185	1017	T80
V_3599	32.9	32.9	629316	4772682	185	1116	T80
V_36	31.3	31.3	613482	4764148	180	1308	T08
V_3601	31.2	31.2	631149	4772987	182	1391	T80
V_3610	35.8	35.8	631146	4772144	180	915	T79
V_365	31.8	31.8	617092	4752191	180	1231	T98
V_3707	38.0	38.5	624405	4763819	180	700	T32
V_3707	38.0	38.5	624405	4763819	180	701	T32
V_371	31.3	31.3	617114	4752046	180	1321	T98
V_374	34.1	34.1	617130	4753476	180	955	T98
V_376	31.6	31.6	617132	4752106	180	1264	T98
V_3819	36.0	36.0	623362	4769601	189	985	T28
V_3820	35.9	35.9	623461	4769538	190	1043	T28
V_3821	37.6	37.6	624183	4769314	189	667	T57
V_3822	32.5	33.7	630973	4765544	190	1091	T18
V_3824	38.3	39.2	621508	4763690	184	703	T74
V_3825	32.6	33.1	620813	4761813	177	1457	T74
V_3827	33.7	34.2	623643	4762762	180	1300	T36
V_3828	33.6	34.2	623646	4762744	180	1307	T36
V_3829	33.1	33.6	623728	4762528	175	1451	T36
V_3830	33.1	33.5	623747	4762525	175	1470	T36
V_3835	34.1	34.1	613197	4766295	190	1045	T52
V_3849	34.2	34.2	628133	4748067	183	1084	T23
V_3850	36.1	36.1	627942	4748221	185	854	T23
V_3861	37.5	37.5	626313	4747934	180	1112	T49
V_3862	37.6	37.7	626355	4748001	180	1032	T49
V_3863	37.6	37.7	626366	4748014	180	1017	T49
V_3875	34.8	34.9	624944	4746585	185	1405	T61
V_3876	35.7	35.8	624861	4746738	185	1272	T61
V_3877	34.7	34.8	625005	4746569	185	1412	T61
V_388	39.4	39.4	617212	4763461	185	735	T51
V_3886	31.3	31.3	616850	4752417	180	1293	T98
V_3892	31.9	31.9	627803	4751535	180	1297	T24
V_3900	35.6	35.6	622573	4769993	186	899	T28
V_394	32.1	32.1	617236	4752117	180	1189	T98
V_4000	36.4	36.5	615236	4765530	188	928	T08
V_404	32.8	32.8	617271	4755281	180	1177	T82
V_419	39.1	39.1	617366	4763479	185	800	T39
V_420	35.8	35.8	617372	4753536	180	784	T98
V_421	33.9	33.9	617373	4754711	180	1037	T82
V_423	35.8	35.8	617381	4767709	191	1108	T93
V_424	36.3	36.4	617384	4753456	180	727	T98
V_430	39.9	39.9	617402	4764893	185	616	T39
V_442	33.4	33.5	617474	4752173	181	1007	T98
V_447	34.6	34.6	617505	4768925	195	1257	T94
V_459	34.2	34.2	617577	4752220	182	917	T98
V_467	39.5	39.5	617660	4764826	185	629	T39
V_470	35.0	35.0	617682	4752260	182	838	T98
V_471	38.4	38.4	617684	4766934	190	668	T93
V_472	38.5	38.5	617686	4767001	190	650	T93
V_48	34.5	34.6	613751	4764503	185	892	T08
V_482	39.1	39.1	617742	4764831	185	677	T39
V_484	37.0	37.0	617767	4755182	180	678	T82
V_487	39.2	39.2	617779	4765797	188	585	T97
V_496	35.2	35.2	617827	4755564	180	859	T82
V_502	38.6	38.7	617864	4763668	185	799	T39
V_510	37.4	37.4	617908	4763284	185	1035	T51
V_515	37.4	37.4	617923	4768749	195	829	T94
V_516	35.7	35.7	617928	4769415	195	1050	T94
V_520	36.7	36.7	617944	4753834	180	792	T98
V_53	35.2	35.2	613971	4764324	185	821	T08

Receptor ID	2015 Results (2015 Amend- ment) Sound Level/ Night	2014 Results (2014 REA Sound Level/ Night	UTM Coordinates (NAD 83, Zone 17)		Z [m]	Distance to the nearest Turbine	Nearest Turbine ID
	dBA	dBA	X [m]	Y [m]			
V_531	36.6	36.6	617998	4753864	180	821	T98
V_533	36.3	36.3	618011	4769403	195	978	T94
V_537	34.0	34.0	618034	4755913	180	1059	T82
V_538	38.3	38.3	618036	4768512	195	759	T94
V_545	37.3	37.3	618057	4766254	190	913	T93
V_55	36.0	36.0	614020	4764387	185	742	T08
V_550	33.6	33.6	618082	4756015	180	1143	T82
V_551	38.4	38.4	618102	4763559	185	727	T07
V_560	36.8	36.8	618197	4752389	184	688	T98
V_563	40.0	40.0	618217	4768489	195	601	T94
V_570	39.5	39.5	618259	4767725	192	601	T93
V_571	32.8	32.8	618270	4756379	180	1469	T82
V_573	32.7	32.7	618291	4756410	180	1498	T82
V_579	38.2	38.2	618337	4769461	195	811	T94
V_586	35.1	35.2	618376	4749190	180	833	T99
V_587	34.7	34.8	618376	4748946	180	877	T99
V_591	38.6	38.6	618410	4769465	194	780	T94
V_597	37.0	37.0	618462	4766271	186	867	T93
V_607	37.2	37.2	618524	4764929	185	884	T07
V_608	36.2	36.2	618535	4748930	180	735	T99
V_626	39.4	39.4	618675	4767749	190	715	T93
V_627	35.5	35.6	618694	4748607	180	803	T99
V_646	37.4	37.4	618761	4764853	185	810	T07
V_653	31.6	31.6	618782	4747855	180	1433	T99
V_657	31.4	31.5	618789	4747811	180	1474	T99
V_669	36.9	36.9	618830	4764950	185	918	T07
V_671	36.6	36.6	618845	4766292	186	984	T93
V_682	36.7	36.7	618887	4769924	190	853	T85
V_707	39.3	39.4	618987	4764486	185	558	T07
V_71	35.2	35.2	614487	4764079	183	834	T08
V_719	37.5	37.6	619078	4763539	181	678	T07
V_721	33.1	33.2	619090	4762737	180	1392	T07
V_724	36.9	37.0	619123	4764964	185	1033	T07
V_728	36.6	36.6	619162	4769939	190	832	T85
V_731	34.2	34.3	619171	4750322	181	1099	T99
V_737	33.4	33.4	619223	4748045	180	1178	T99
V_745	35.3	35.4	619297	4750161	181	942	T99
V_748	36.7	36.7	619308	4766370	188	1003	T54
V_750	33.5	33.5	619311	4752272	185	1493	T42
V_751	35.4	35.4	619325	4752841	185	996	T42
V_759	39.0	39.0	619387	4767898	193	683	T66
V_771	37.4	37.4	619440	4756078	180	1095	T19
V_781	37.7	37.8	619558	4764910	185	785	T54
V_788	38.4	38.4	619630	4764978	185	692	T54
V_794	38.1	38.1	619700	4766284	188	731	T54
V_804	38.0	38.0	619754	4753023	185	631	T42
V_809	37.3	37.3	619790	4749853	180	857	T99
V_814	36.5	36.5	619828	4750030	180	1017	T99
V_823	38.7	38.7	619906	4749574	180	757	T20
V_825	37.9	37.9	619930	4766397	189	803	T54
V_826	31.6	31.7	619935	4746988	182	1454	T05
V_830	31.9	32.1	619977	4747046	182	1388	T05
V_837	31.8	32.0	620011	4746987	183	1391	T05
V_838	37.7	37.7	620011	4754703	184	893	T19
V_84	32.7	32.8	614732	4770110	200	1245	T83
V_845	34.5	34.6	620042	4751132	184	1456	T96
V_846	32.6	32.6	620047	4770202	185	1424	T85
V_847	32.8	32.8	620047	4770144	185	1380	T85
V_849	34.7	34.7	620051	4769722	188	1103	T85
V_852	35.6	35.7	620056	4769504	190	1002	T85
V_855	39.8	39.8	620068	4749448	181	569	T20
V_864	37.7	37.7	620095	4754636	185	925	T19
V_867	32.5	32.6	620115	4747051	183	1268	T05
V_868	32.2	32.4	620116	4746984	183	1306	T05
V_869	35.0	35.1	620119	4751004	183	1346	T96
V_871	32.3	32.3	620121	4770225	185	1490	T85
V_875	35.3	35.4	620143	4750856	182	1293	T96
V_888	37.3	37.3	620209	4757857	184	961	T72
V_890	35.6	35.6	620212	4750883	182	1230	T96
V_915	34.7	34.8	620307	4767830	193	1372	T66
V_93	34.3	34.4	614859	4770309	200	1044	T83
V_933	34.1	34.1	620362	4758485	182	1441	T72
V_934	39.1	39.1	620362	4766347	188	669	T38
V_935	38.9	39.0	620366	4764935	187	782	T54



Receptor ID	2015 Results (2015 Amend- ment) Sound Level/ Night	2014 Results (2014 REA Sound Level/ Night	UTM Coordinates (NAD 83, Zone 17)		Z [m]	Distance to the nearest Turbine	Nearest Turbine ID
	dBA	dBA	X [m]	Y [m]			
V_936	37.2	37.2	620367	4757957	184	953	T72
V_938	36.7	36.8	620388	4750654	181	1035	T96
V_961	38.5	38.5	620501	4753403	185	609	T42
V_967	38.3	38.3	620536	4754767	185	765	T19
V_970	34.3	34.4	620551	4747000	185	977	T05
V_976	38.9	38.9	620577	4754856	184	689	T19
V_979	35.2	35.7	620607	4763615	185	1193	T75

## **Appendix D Equipment Specification**

---

## Transformer Dimensions and Lw calculation

### Transformer 100 MVA

SPL NEMA: 88 dB **Note 1**  
 Transformer Dimensions: H: 2.5 L: 2.9 W: 3.7 **Note 2**  
 Estimated Transformer Area 33  
 NEMA Area 58  
 Lw: 106 dB

#### Correction Factors

Octave Band Centre Freq {hz}	31.5	63	125	250	500	1000	2000	4000	8000	dBz/dBA
Correction (Bies and Hansen)		5	7	2	2	-4	-9	-14	-21	
Adjustment to match NEMA power	<b>10</b>									
Oct. Band Level (Linear)	101	103	98	98	92	87	82	75	106	
A weight Correction	26	16	9	3	0	-1	-1	1		
Oct. Band Level (A-Weighted)	74	87	89	94	92	88	83	74	<b>98</b>	

## Acoustical datasheet for a measurement of a wind power turbine

Acoustic measurements for a determination of acoustic emission effect of a wind power turbine type ENERCON E 101 (Power reduced to 2,950 kW) in accordance to DIN 61400-11 / IEC 61400-11 :2002 on 05.05.2014, Project No. 15-054-GH-02

General information		Technical data (from the manufacturer)	
Turbine manufacturer:	Enercon GmbH Dreerkamp 5 D-26605 Aurich	Maximum rated power:	3,050 kW
Serial no.:	1010356	Measured rated power:	2,950 kW (reduced)
WT location:	WP Dalwitz	Rotor diameter:	101 m
		Hub height over the ground:	135,4 m
		Tower construction:	Steel and precast concrete
		Power control:	Pitch
Rotor additional data (from the manufacturer)		Additional data of the gearbox and the generator (from the manufacturer)	
Rotor blade manufacturer:	ENERCON GmbH	Gearbox manufacturer:	none
Type:	E 101-1	Gearbox type:	none
Rotor blade control:	variable	Generator manufacturer:	ENERCON GmbH
No. of rotor blades:	3	Generator type:	G101/30-G2
Nominal rotor speed:	4 -14,7 RPM	Nominal generator speed:	4 -14,7 RPM
Measured rotor speed:	4 -14,1 RPM (reduced)	Measured generator speed:	4 -14,1 RPM (reduced)

Power curve: OM II 2,950 kW (from the manufacturer)

	Reference point		Noise emission parameters	Note
	Standardized wind speed at 10 m height	Electrical power		
Sound-power-level $L_{WA,P}$	6 $ms^{-1}$	1,556 kW	99,5 dB(A)	(1)
	7 $ms^{-1}$	2,255 kW	101,4 dB(A)	
	7,8 $ms^{-1}$	2,803 kW	102,0 dB(A)	
	8 $ms^{-1}$	2,857 kW	102,2 dB(A)	
Tonality at a close range $K_{TN}$	6 $ms^{-1}$	1,556 kW	0 dB	(1)
	7 $ms^{-1}$	2,255 kW	0 dB	
	7,8 $ms^{-1}$	2,803 kW	0 dB	
	8 $ms^{-1}$	2,857 kW	0 dB	
Impulsiveness at a close range $K_{IN}$	6 $ms^{-1}$	1,556 kW	0 dB	(1)
	7 $ms^{-1}$	2,255 kW	0 dB	
	7,8 $ms^{-1}$	2,803 kW	0 dB	
	8 $ms^{-1}$	2,857 kW	0 dB	

Note: (1) For the acoustic-power-levels denoted here are derived at an operation point with 95% of the reduced rated power (2,950 kW) under the consideration of the given power curve and the hub height of the WT at  $v_{10} = 7,8 ms^{-1}$  at 10 m height above the ground.

Measured by: T&H Ingenieure GmbH  
Bremerhavener Heerstraße 10  
D-28717 Bremen  
www.th-ingenieure.de  
info@th-ingenieure.de  
Tel.: +49(0) 421 698993-15

**T&H INGENIEURE**  
Baugrunderhaltung und Gebäudetechnik AGGmbH



Date: 22.05.2015

Signature  
Dipl. Ing. (FH) Jürgen Hünerberg

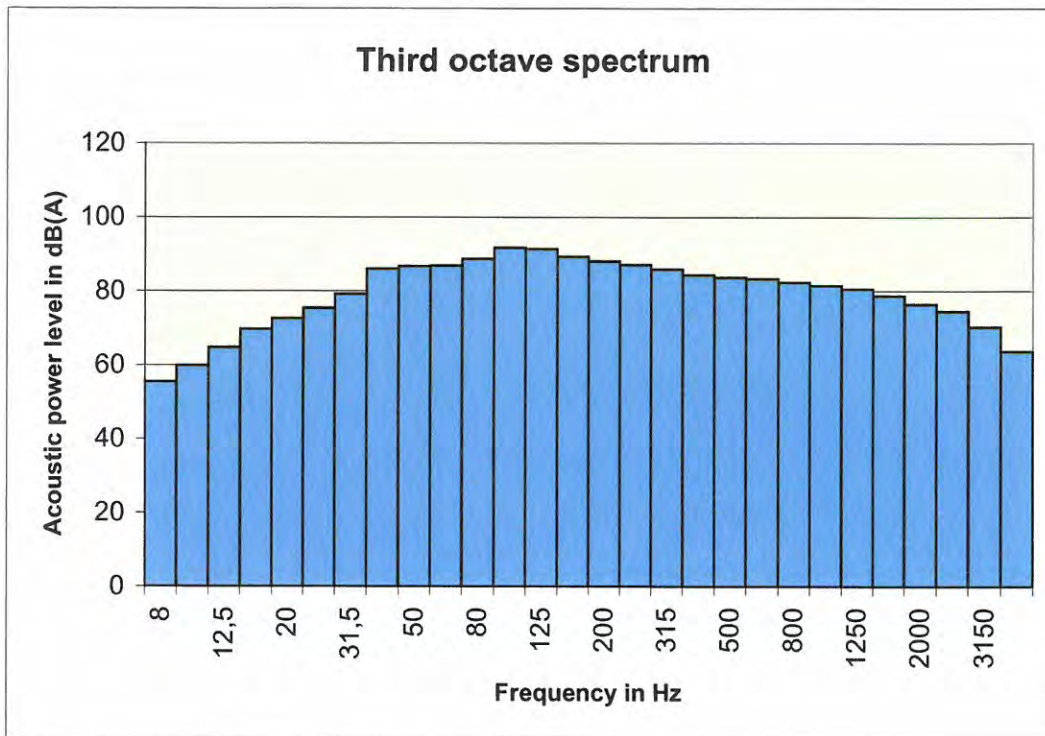

**Third octave sound power level for vs = 6 m/s in dB(A)**

Frequency in Hz	L <sub>WA,P</sub> in dB(A)	Uncertainty Uc in dB	Frequency in Hz	L <sub>WA,P</sub> in dB(A)	Uncertainty Uc in dB
20	55,4	3,2	500	88,1	1,1
25	59,9	1,8	630	87,1	1,2
31,5	64,8	1,7	800	86,0	1,2
40	69,7	1,5	1 k	84,4	1,4
50	72,6	1,9	1,25 k	83,7	1,6
63	75,5	2,0	1,6 k	83,3	1,6
80	79,3	1,7	2 k	82,4	1,5
100	86,0	1,6	2,5 k	81,6	1,4
125	86,7	1,3	3,15 k	80,6	1,7
160	86,9	1,3	4 k	78,7	2,1
200	88,7	1,2	5 k	76,5	3,0
250	91,7	1,1	6,3 k	74,6	2,6
315	91,4	1,1	8 k	70,3	2,2
400	89,3	1,1	10 k	63,7	3,4

**Appendix 4.5.1**

Background corrected third octave spectra at vs = 6 m/s

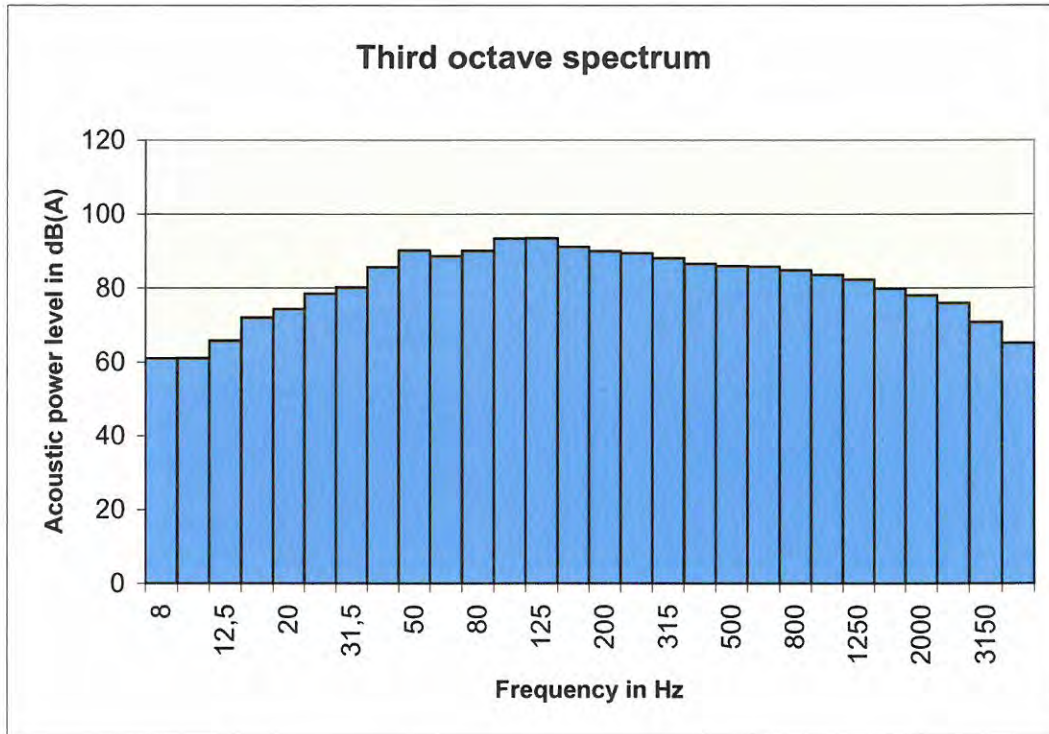

**Third octave sound power level for vs = 7 m/s in dB(A)**

Frequency in Hz	L <sub>WA,P</sub> in dB(A)	Uncertainty Uc in dB	Frequency in Hz	L <sub>WA,P</sub> in dB(A)	Uncertainty Uc in dB
20	61,0	1,3	500	90,0	1,2
25	61,1	2,1	630	89,4	1,3
31,5	65,8	1,9	800	88,1	1,4
40	72,1	1,4	1 k	86,6	1,6
50	74,3	1,7	1,25 k	86,0	1,8
63	78,5	1,6	1,6 k	85,8	1,7
80	80,2	1,6	2 k	84,9	1,6
100	85,6	1,4	2,5 k	83,6	1,8
125	90,2	1,1	3,15 k	82,3	2,1
160	88,6	1,2	4 k	79,9	2,7
200	90,0	1,2	5 k	78,1	3,0
250	93,4	1,1	6,3 k	76,0	2,6
315	93,4	1,1	8 k	70,8	3,2
400	91,2	1,1	10 k	65,2	3,5

**Appendix 4.5.2**

Background corrected third octave spectra at vs = 7 m/s



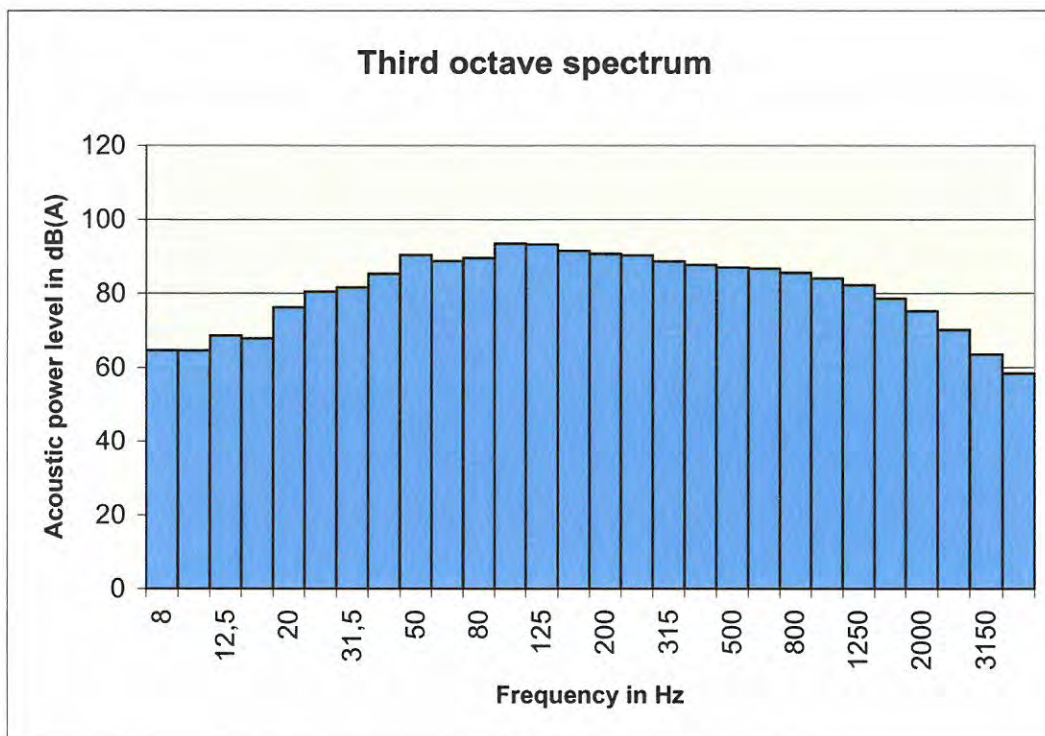

**Third octave sound power level for  $v_s = 8$  m/s in dB(A)**

Frequency in Hz	$L_{WA,P}$ in dB(A)	Uncertainty $U_c$ in dB	Frequency in Hz	$L_{WA,P}$ in dB(A)	Uncertainty $U_c$ in dB
20	64,6	2,6	500	90,7	1,2
25	64,6	2,6	630	90,3	1,2
31,5	68,6	2,9	800	88,6	1,4
40	67,9	7,6	1 k	87,7	1,3
50	76,3	2,7	1,25 k	87,0	1,3
63	80,5	2,1	1,6 k	86,7	1,3
80	81,6	2,0	2 k	85,6	1,3
100	85,4	1,5	2,5 k	84,0	1,5
125	90,4	1,2	3,15 k	82,3	1,8
160	88,7	1,2	4 k	78,6	2,6
200	89,6	1,4	5 k	75,2	3,4
250	93,5	1,3	6,3 k	70,2	4,0
315	93,2	1,2	8 k	63,5	5,3
400	91,5	1,3	10 k	58,4	6,2

**Appendix 4.5.3**

Background corrected third octave spectra at  $v_s = 8$  m/s

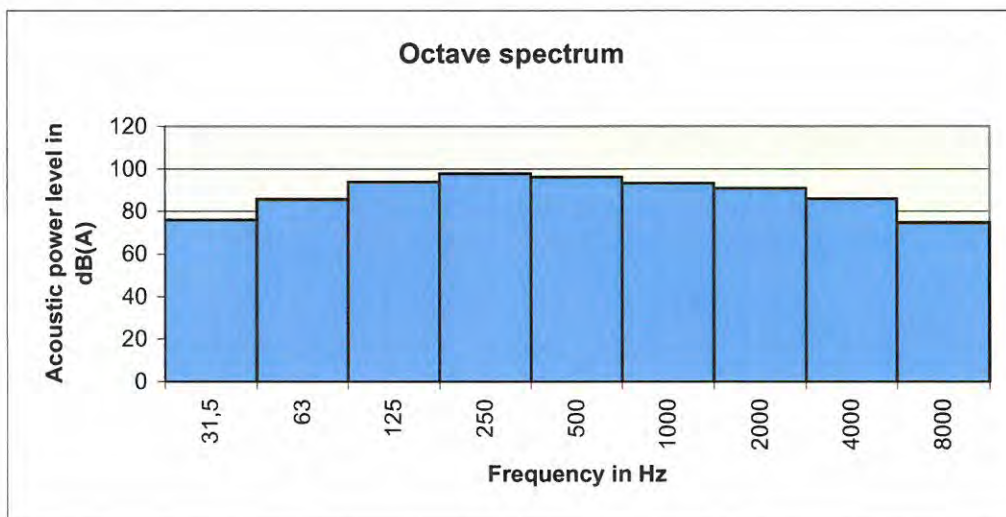
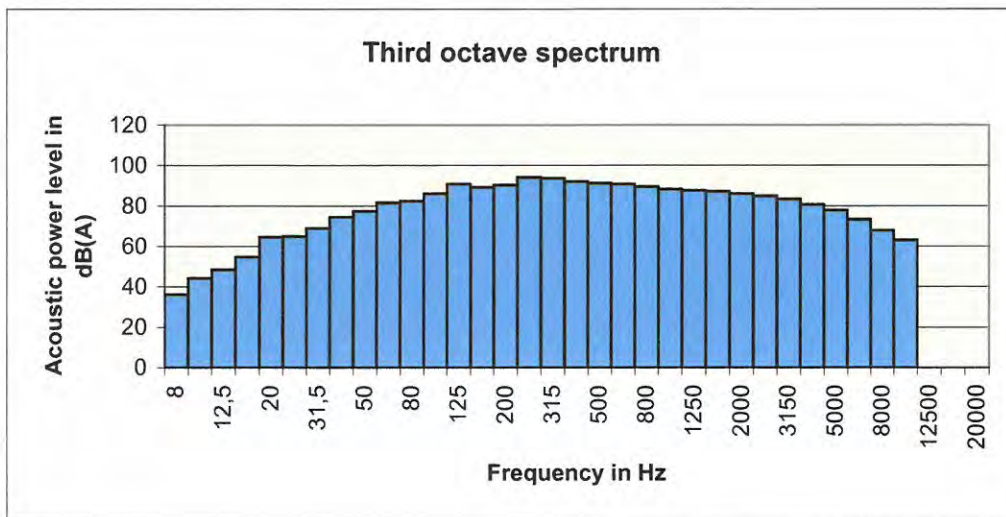

Third octave sound power level for $v_s = 7,8$ m/s in dB(A)												
Frequency	8	10	12,5	16	20	25	31,5	40	50	63	80	100
$L_{WA,P}$	36,2	44,2	48,4	54,7	64,5	64,9	69,0	74,5	77,3	81,5	82,5	86,0
Frequency	125	160	200	250	315	400	500	630	800	1 k	1,25 k	1,6 k
$L_{WA,P}$	90,7	89,2	90,4	94,0	93,7	92,0	91,3	90,8	89,4	88,3	87,6	87,2
Frequency	2 k	2,5 k	3,15 k	4 k	5 k	6,3 k	8 k	10 k				
$L_{WA,P}$	86,1	84,8	83,4	80,6	77,8	73,3	67,7	63,1				
Octave sound power level for $v_s = 7,8$ m/s in dB(A)												
Frequency	31,5	63	125	250	500	1000	2000	4000	8000			
$L_{WA,P}$	75,9	85,7	93,8	97,8	96,1	93,3	90,9	86,0	74,7			

**Appendix 4.5.4**

Background corrected third octave and octave spectrum at  $v_s = 7.8$  m/s

# Sound Power Level of the ENERCON E-101 2.9 MW G2/G3

**Publisher:**

ENERCON Canada Inc.  
700, rue de La Gauchetière ouest Bureau 1200  
Montréal, QC, H3B 5M2  
+1 514 ENERCON (+1 514 363 7266)

**Copyright:**

© ENERCON Canada Inc. Any reproduction, distribution and utilisation of this document as well as the communication of its contents to third parties without express authorisation is prohibited. Violators will be held liable for monetary damages. All rights reserved in the event of the grant of a patent, utility model or design.

**Content subject to change:**

ENERCON Canada Inc. reserves the right to change, improve and expand this document and the subject matter described herein at any time without prior notice.

Author/date:	H.Shahriar /05.05.15	Translator/date:	N.Nnnn / DD.MM.YY
Department:	Commercial	Revisor/date:	N.Nnnn / DD.MM.YY
Approved/date:	M. Weidemann/25.06.15	Reference:	Sound Power Level E-101 2.9 G2_G3.doc
Released/date:	H.Shahriar /03.07.15		

The following represents the sound power level of the E-101 2.9 MW G2/G3 for the entire operational range of wind speeds in accordance with the measurement technique IEC 61 400 – 11:2002 and A1:2006.

**Sound Power Level (SPL) for the E-101 2.9 MW G2/G3**

Hub Height Vs in 10m height		124m	
6 m/s		99.5 dB(A)	
7 m/s		101.4 dB(A)	
8 m/s		102.2 dB(A)	
9 m/s		102.9* dB(A)	
10 m/s		102.9* dB(A)	
>95% rated power		102.2 dB(A)	

Measurement results of the octave band corresponding to 95% or higher rated power are presented in the table below. ENERCON confirms the measurement values to be representative values of the E-101 2.9 MW noise levels.

	Octave band sound power level in dB(A)								
Frequency (Hz)	63	125	250	500	1,000	2,000	4,000	8,000	dB(A)
<b>E-101 2.9 MW @ 8m/s</b>	84.7	93.4	97.2	95.6	92.6	90.3	84.4	71.1	102.2

\*Recommended broadband sound power level for use in noise model. The typical octave bands corresponding to the sound power level at 9 m/s and 10 m/s are provided in the table below.

	Octave band sound power level in dB(A) for 9 m/s and 10 m/s								
Frequency (Hz)	63	125	250	500	1,000	2,000	4,000	8,000	dB(A)
<b>Sound power level</b>	83.7	92.0	96.1	98.4	97.0	90.2	85.2	81.9	102.9

Author/date:	H.Shahriar /05.05.15	Translator/date:	N.Nnnn / DD.MM.YY
Department:	Commercial	Revisor/date:	N.Nnnn / DD.MM.YY
Approved/date:	M. Weidemann/25.06.15	Reference:	Sound Power Level E-101 2.9 G2_G3.doc
Released/date:	H.Shahriar /03.07.15		

1. The relation between the sound power level and the standardized wind speed  $V_s$  in 10 m height as shown above is valid on the premise of a logarithmic wind profile with a roughness length of 0.05m. The relation between the sound power level and the wind speed at hub heights applies for all hub heights. During the sound measurements the wind speeds are derived from the power output and the power curve of the WEC.
2. A tonal audibility of  $\Delta L_{a,k} \leq 2$  dB can be expected over the whole operational range and is valid in the near vicinity of the turbine according to IEC 61 400 -11 ed. 2.
3. Sound power level values provided in the table are valid for the calculated power curve of the E-101 D0331249-0 (V1.0).
4. Due to typical measurement uncertainties, if the sound power level is measured according to the accepted method, the measured values can differ from the values shown in this document in the range of +/- 1dB.

Accepted measurement method:

IEC 61400-11 ed.2 ("Wind turbine generator systems – Part 11: Acoustic noise measurement techniques; Second edition, 2002 – 12").

If the difference between tonal noise and background noise during a measurement is less than 6 dB, a higher uncertainty must be considered.

5. The sound power level of a wind turbine depends on several factors such as, but not limited to, regular maintenance and day-to-day operation in compliance with the manufacturer's operating instructions.

Author/date:	H.Shahriar /05.05.15	Translator/date:	N.Nnnn / DD.MM.YY
Department:	Commercial	Revisor/date:	N.Nnnn / DD.MM.YY
Approved/date:	M. Weidemann/25.06.15	Reference:	Sound Power Level E-101 2.9 G2_G3.doc
Released/date:	H.Shahriar /03.07.15		

# Sound Power Level of the ENERCON E-101 3.0 MW

**Publisher:**

ENERCON Canada Inc.  
1000, rue de La Gauchetière ouest Bureau 2310  
Montréal, QC, H3B 4W5  
+1 514 ENERCON (+1 514 363 7266)

**Copyright:**

© ENERCON Canada Inc. Any reproduction, distribution and utilisation of this document as well as the communication of its contents to third parties without express authorisation is prohibited. Violators will be held liable for monetary damages. All rights reserved in the event of the grant of a patent, utility model or design.

**Content subject to change:**

ENERCON Canada Inc. reserves the right to change, improve and expand this document and the subject matter described herein at any time without prior notice.

Author/date:	H.Shahriar /15.06.12	Translator/date:	N.Nnnn / DD.MM.YY
Department:	Sales	Revisor/date:	H.Shahriar / 11.04.14
Approved/date:	M. Weidemann/11.04.14	Reference:	Sound Power Level E-101 NRWC 140415.doc
Released/date:	H.Shahriar /15.04.14		



The following represents the sound power level of the E-101 3.0 MW for the entire operational range of wind speeds in accordance with the measurement technique IEC 61 400 – 11:2002 and A1:2006.

### Sound Power Level (SPL) for the E-101 with 3.0 MW rated power

Vs in 10m height \ Hub Height	99m	124m	135m
<b>6 m/s</b>	<b>103.6 dB(A)</b>	<b>103.6 dB(A)</b>	<b>103.8 dB(A)</b>
<b>7 m/s</b>	<b>104.3 dB(A)</b>	<b>104.3 dB(A)</b>	<b>104.5 dB(A)</b>
<b>8 m/s</b>	<b>104.8 dB(A)</b>	<b>104.8 dB(A)</b>	<b>104.8 dB(A)</b>
<b>9 m/s</b>	<b>104.8 dB(A)</b>	<b>104.8 dB(A)</b>	<b>104.8 dB(A)</b>
<b>10 m/s</b>	<b>104.8 dB(A)</b>	<b>104.8 dB(A)</b>	<b>104.8 dB(A)</b>
<b>95% rated power</b>	<b>104.8 dB(A)</b>	<b>104.8 dB(A)</b>	<b>104.8 dB(A)</b>

Measurement results of the octave band corresponding to 95% or higher rated power are presented in the table below. ENERCON confirms the measurements values to be representative values of the E-101 3.0 MW noise levels.

Frequency (Hz)	Octave band sound power level in dB(A)								dB(A)
	63	125	250	500	1,000	2,000	4,000	8,000	
<b>E-101 3.0 MW @ 8.3m/s</b>	86.3	91.6	98.6	100.8	98.3	92.8	85.9	73.3	104.8

1. The relation between the sound power level and the standardized wind speed  $V_s$  in 10 m height as shown above is valid on the premise of a logarithmic wind profile with a roughness length of 0.05m. The relation between the sound power level and the wind speed at hub heights applies for all hub heights. During the sound measurements the wind speeds are derived from the power output and the power curve of the WEC.
2. A tonal audibility of  $\Delta L_{a,k} \leq 2 \text{ dB}$  can be expected over the whole operational range and is valid in the near vicinity of the turbine according to IEC 61 400 -11 ed. 2.

Author/date:	H.Shahriar /15.06.12	Translator/date:	N.Nnnn / DD.MM.YY
Department:	Sales	Revisor/date:	H.Shahriar / 11.04.14
Approved/date:	M. Weidemann/11.04.14	Reference:	Sound Power Level E-101 NRWC 140415.doc
Released/date:	H.Shahriar /15.04.14		

3. Sound power level values provided in the table are valid for the **Operational Mode I**. The respective power curve is the calculated power curve of the E-101 dated October 2009 (Rev 2.0).
4. Due to typical measurement uncertainties, if the sound power level is measured according to the accepted method, the measured values can differ from the values shown in this document in the range of +/- 1dB.

Accepted measurement method:

IEC 61400-11 ed.2 ("Wind turbine generator systems – Part 11: Acoustic noise measurement techniques; Second edition, 2002 – 12").

If the difference between total noise and background noise during a measurement is less than 6 dB, a higher uncertainty must be considered.

5. The sound power level of a wind turbine depends on several factors such as, but not limited to, regular maintenance and day-to-day operation in compliance with the manufacturer's operating instructions.

Author/date:	H.Shahriar /15.06.12	Translator/date:	N.Nnnn / DD.MM.YY
Department:	Sales	Revisor/date:	H.Shahriar / 11.04.14
Approved/date:	M. Weidemann/11.04.14	Reference:	Sound Power Level E-101 NRWC 140415.doc
Released/date:	H.Shahriar /15.04.14		

## Summary of Test Report (Measured hub height of 99 m) /1/

Master Data Sheet "Geräusche" (Noise), in accordance with  
 "Technische Richtlinien für Windenergieanlagen, Teil 1: Bestimmung der Schallemissionswerte"  
 (Technical Guidelines for Wind Turbine Generators, Part 1: Determination of sound emission values)

Rev. 18 of February 1, 2008 (Editor: Fördergesellschaft Windenergie e.V. Stresemannplatz 4, D-24103 Kiel)

Extract of Test Report 213122-02.01 IEC  
 on noise emission of wind turbine generator of type E-101

General Data		Technical Data (manufacturer's specifications)	
Manufacturer of WTG:	Enercon GmbH	Rated power (generator):	3,050 (3,250) kW
Serial number:	1010002	Diameter of rotor:	101 m
Location of WTG (approx.):	49733 Haren	Hub height above ground:	99 m
Geographic co-ordinates:	GK longitude: 25.76.214 GK latitude: 58.59.856	Type of tower:	conical tubular concrete
		Power control:	Pitch
Complementary rotor data (manufacturer's specifications)		Complementary data of gear unit and generator (manufacturer's specifications)	
Manufacturer of rotor blade:	Enercon	Manufacturer of gear unit:	not applicable
Type of rotor blade:	E-101-1	Type of gear unit:	not applicable
Blade setting angle:	variable	Manufacturer of generator:	Enercon
Number of rotor blades:	3	Type of generator:	G-101/30-G2
Rotor speed range:	5 to 14.7 rpm. (mode OM I)	Rated speed of generator:	5 to 14.7 rpm. (mode OM I)

Calculated Performance Chart: Performance characteristic E101 3 MW OM I ; calculated by ENERCON (Rev. 1.0)

	Reference Point		Noise emission parameters	Observations
	standardized wind speed at a height of 10 m	true electrical power		
sound power level $L_{WA,P}$	6 $ms^{-1}$	1,414 kW	103.6 dB(A)	
	7 $ms^{-1}$	2,077 kW	104.3 dB(A)	
	8 $ms^{-1}$	2,751 kW	104.8 dB(A)	
	9 $ms^{-1}$	2,987 kW	104.6 dB(A)	(1)
	10 $ms^{-1}$	3,050 kW	--	(2)
tonal audibility $\Delta L_{a,k}$	6 $ms^{-1}$	1,414 kW	- 1.5 dB	
	7 $ms^{-1}$	2,077 kW	0 dB	
	8 $ms^{-1}$	2,751 kW	0 dB	
	9 $ms^{-1}$	2,987 kW	0 dB	(1)
	10 $ms^{-1}$	3,050 kW	--	(2)
impulse adjustment for immediate vicinity $K_{IN}$	6 $ms^{-1}$	1,414 kW	0 dB	
	7 $ms^{-1}$	2,077 kW	0 dB	
	8 $ms^{-1}$	2,751 kW	0 dB	
	9 $ms^{-1}$	2,987 kW	0 dB	(1)
	10 $ms^{-1}$	3,050 kW	--	(2)

Third-octave band sound power level for $v_s = 6 ms^{-1}$ in dB(A)												
Frequency	50	63	80	100	125	160	200	250	315	400	500	630
$L_{WA,P}$	78.3	81.8*	83.0**	84.2	89.6	85.7*	89.2	92.7	94.1	94.6	95.1	94.9
Frequency	800	1,000	1,250	1,600	2,000	2,500	3,150	4,000	5,000	6,300	8,000	10,000
$L_{WA,P}$	93.5	91.6	90.0	89.0	85.4	84.1	82.3	79.3	74.8	67.8*	64.7**	65.3**

Octave band sound power level for $v_s = 6 ms^{-1}$ in dB(A)								
Frequency	63	125	250	500	1,000	2,000	4,000	8,000
$L_{WA,P}$	85.6*	91.9	97.2	99.6	96.7	91.5	84.6	70.3*

Third-octave band sound power level for $v_s = 7 ms^{-1}$ in dB(A)												
Frequency	50	63	80	100	125	160	200	250	315	400	500	630
$L_{WA,P}$	78.9	83.3	84.0	84.9	88.2	86.4*	89.6	94.7	94.9	95.4	95.8	95.5
Frequency	800	1,000	1,250	1,600	2,000	2,500	3,150	4,000	5,000	6,300	8,000	10,000
$L_{WA,P}$	94.0	92.0	90.4	89.3	86.1	84.7	82.9	79.9	74.4*	68.4*	64.6**	62.7**

Octave band sound power level for $v_s = 7 ms^{-1}$ in dB(A)								
Frequency	63	125	250	500	1,000	2,000	4,000	8,000
$L_{WA,P}$	87.3	91.5	98.4	100.3	97.1	91.9	85.0	71.5**

Third-octave band sound power level for $v_s = 8 \text{ ms}^{-1}$ in dB(A)												
Frequency	50	63	80	100	125	160	200	250	315	400	500	630
L <sub>WAP</sub>	82.1	82.8	84.4	88.4	86.8	90.1	94.8	95.0	95.6	96.3	96.2	82.1
Frequency	800	1,000	1,250	1,600	2,000	2,500	3,150	4,000	5,000	6,300	8,000	10,000
L <sub>WAP</sub>	95.0	93.3	91.5	90.4	86.7	85.4	83.7	80.9	75.9	69.7*	67.1**	65.5**
Octave band sound power level for $v_s = 8 \text{ ms}^{-1}$ in dB(A)												
Frequency	63	125	250	500	1,000	2,000	4,000	8,000				
L <sub>WAP</sub>	86.3	91.6	98.6	100.8	98.3	92.8	86.0	73.3**				
Third-octave band sound power level for $v_s = 9 \text{ ms}^{-1}$ in dB(A)												
Frequency	50	63	80	100	125	160	200	250	315	400	500	630
L <sub>WAP</sub>	78.6	81.9	82.4*	83.9	87.8	85.9*	88.6	93.8	94.2	95.1	96.0	96.3
Frequency	800	1,000	1,250	1,600	2,000	2,500	3,150	4,000	5,000	6,300	8,000	10,000
L <sub>WAP</sub>	95.4	93.8	92.3	91.0	87.4	86.0	84.1	81.1	76.7	71.7	68.4	66.8*
Octave band sound power level for $v_s = 9 \text{ ms}^{-1}$ in dB(A)												
Frequency	63	125	250	500	1,000	2,000	4,000	8,000				
L <sub>WAP</sub>	86.0	90.8	97.6	100.6	98.8	93.5	86.4	74.2				

This summary of the test report is valid only in combination with the manufacturer's certificate dated 12/03/2013.

**These specifications do not replace the test report mentioned above (particularly for noise immission predictions).**

- Observations:
- (1) Maximum value of standardized wind speed during the WTG-operation measurement  $v_s = 8,9 \text{ m/s}$
  - (2) Due to weather conditions, no data available during WTG operation
- \* Difference between working and background noise < 6 dB, correction by 1.3 dB
- \*\* Difference between working and background noise < 3 dB, values shall not be presented

/1/ Wind turbine generator systems – Part 11: Acoustic noise; measurement techniques (IEC 61400-11:2002 and A1:2006); German version DIN EN 61400-11:2007

Measured by: KÖTTER Consulting Engineers  
- Rheine -

  
Dipl.-Ing. Oliver Bunk

  
Matthias Humpohl, B.Sc.

Date: 23/04/2013



### Vorläufiger Auszug aus dem Prüfbericht

Stamblatt "Geräusche", entsprechend den "Technischen Richtlinien für Windenergieanlagen, Teil 1: Bestimmung der Schallemissionswerte"

Rev. 18 vom 01. Februar 2008 (Herausgeber: Forstgesellschaft Windenergie e.V. Siresemanplatz 4, D-24103 Kiel)

Auszug aus dem Prüfbericht 213121-01.01 zur Schallemission einer Windenergieanlage vom Typ E-101												
Allgemeine Angaben		Technische Daten (Herstellerangaben)										
Anlagenhersteller	Enercon GmbH	Nennleistung (Generator):	3,0 (3,25) MW									
Seriennummer:	1010002	Rotordurchmesser:	101 m									
WEA-Standort (ca.):	49733 Haren	Nabenhöhe über Grund:	99 m									
Standortkoordinaten:	RW: 25.76.214 HW: 58.59.856	Turmbauart:	Beton									
		Leistungsregelung:	Pitch									
Ergänzende Daten zum Rotor (Herstellerangaben)		Ergänzende Daten zu Getriebe und Generator (Herstellerangaben)										
Rotorblatthersteller	Enercon	Getriebehersteller	entfällt									
Typenbezeichnung Blatt:	E-101-1	Typenbezeichnung Getriebe:	entfällt									
Blatteinstellwinkel:	variabel	Generatorhersteller	Enercon									
Rotorblattanzahl:	3	Typenbezeichnung Generator:	G-101/30-G2									
Rotordrehzahlbereich:	5 - 14,7 U/min	Generatormendrehzahl:	14,7 U/min									
Leistungskurve: Leistungskennlinie E101 3 MW OM I (berechnet) der Enercon GmbH zur E-101 vom 05.07.2012												
	Referenzpunkt		Schallemissions- Parameter	Bemerkungen								
	Normierte Windgeschwindig- keit in 10 m Höhe	Elektrische Wirkleistung										
Schalleistungs-Pegel L <sub>WA,P</sub>	6 ms <sup>-1</sup>	1.414 kW	103,6 dB(A)									
	7 ms <sup>-1</sup>	2.077 kW	104,3 dB(A)									
	8 ms <sup>-1</sup>	2.751 kW	104,7 dB(A)									
	9 ms <sup>-1</sup>	2.987 kW	104,6 dB(A)									
	10 ms <sup>-1</sup>	3.050 kW	-- dB(A)	(2)								
	8,3 ms <sup>-1</sup>	2.850 kW	104,8 dB(A)	(1)								
Tonzuschlag für den Nahbereich K <sub>TN</sub>	6 ms <sup>-1</sup>	1.414 kW	0 dB bei 116 Hz									
	7 ms <sup>-1</sup>	2.077 kW	0 dB									
	8 ms <sup>-1</sup>	2.751 kW	0 dB									
	9 ms <sup>-1</sup>	2.987 kW	0 dB									
	10 ms <sup>-1</sup>	3.050 kW	-- dB	(2)								
	8,3 ms <sup>-1</sup>	2.850 kW	0 dB	(1)								
Impulszuschlag für den Nahbereich K <sub>IN</sub>	6 ms <sup>-1</sup>	1.414 kW	0 dB									
	7 ms <sup>-1</sup>	2.077 kW	0 dB									
	8 ms <sup>-1</sup>	2.751 kW	0 dB									
	9 ms <sup>-1</sup>	2.987 kW	0 dB									
	10 ms <sup>-1</sup>	3.050 kW	-- dB	(2)								
	8,3 ms <sup>-1</sup>	2.850 kW	0 dB	(1)								
<b>Terz-Schalleistungspegel</b> für v <sub>s</sub> = 8,3 ms <sup>-1</sup> in dB(A) entsprechend dem maximalen Schalleistungspegel												
Frequenz	50	63	80	100	125	160	200	250	315	400	500	630
L <sub>WA,P,max</sub>	78,8	82,1	82,7	84,4	88,4	86,7	90,0	94,8	95,0	95,6	96,3	96,2
Frequenz	800	1.000	1.250	1.600	2.000	2.500	3.150	4.000	5.000	6.300	8.000	10.000
L <sub>WA,P,max</sub>	95,0	93,3	91,5	90,4	86,6	85,4	83,7	80,8	75,8	69,7*	67,1**	65,5**
<b>Okta-Schalleistungspegel</b> für v <sub>s</sub> = 8,3 ms <sup>-1</sup> in dB(A) entsprechend dem maximalen Schalleistungspegel												
Frequenz	63	125	250	500	1.000	2.000	4.000	8.000				
L <sub>WA,P,max</sub>	86,3	91,6	98,6	100,8	98,3	92,8	85,9	73,3**				

Dieser Auszug aus dem Prüfbericht gilt nur in Verbindung mit der Herstellerbescheinigung vom 13.03.2013.

Die Angaben ersetzen nicht den o. g. Prüfbericht (insbesondere bei Schallimmissionsprognosen).

- Bemerkungen:
- (1) Die normierte Windgeschwindigkeit von v<sub>s</sub> = 8,3 ms<sup>-1</sup> entspricht 95 % der Nennleistung.
  - (2) Witterungsbedingt keine Daten vorhanden
  - \* Abstand zwischen Anlagengeräusch und Fremdgeräusch < 6 dB, Pegelkorrektur um 1,3 dB
  - \*\* Abstand zwischen Anlagengeräusch und Fremdgeräusch < 3 dB, keine Pegelkorrektur

Gemessen durch: KÖTTER Consulting Engineers GmbH & Co. KG

Datum: 13.01.2013

i. V. Dipl.-Ing. Oliver Bunk

i. A. Matthias Humpohl, B. Sc.

# E101

3,000 kW



## Calculated power curve

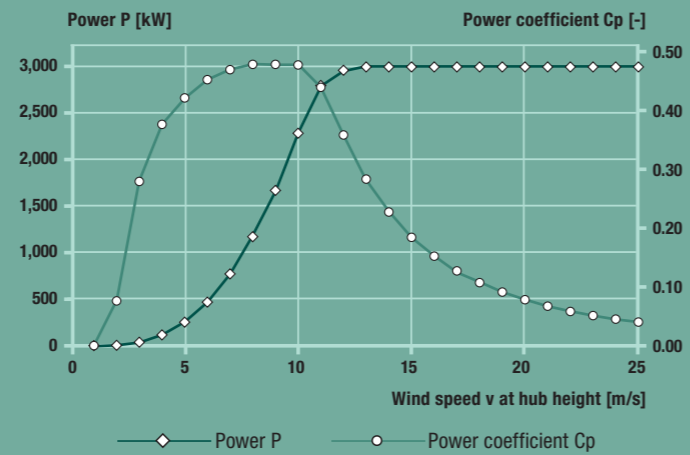

Wind [m/s]	Power P [kW]	Power coefficient Cp [-]
1	0.0	0.000
2	3.0	0.076
3	37.0	0.279
4	118.0	0.376
5	258.0	0.421
6	479.0	0.452
7	790.0	0.469
8	1,200.0	0.478
9	1,710.0	0.478
10	2,340.0	0.477
11	2,867.0	0.439
12	3,034.0	0.358
13	3,050.0	0.283
14	3,050.0	0.227
15	3,050.0	0.184
16	3,050.0	0.152
17	3,050.0	0.127
18	3,050.0	0.107
19	3,050.0	0.091
20	3,050.0	0.078
21	3,050.0	0.067
22	3,050.0	0.058
23	3,050.0	0.051
24	3,050.0	0.045
25	3,050.0	0.040

$\rho = 1.225 \text{ kg/m}^3$

For more information on the ENERCON power curve, please see the last page.

## Technical specifications E-101

Rated power: 3,000 kW  
 Rotor diameter: 101 m  
 Hub height: 99 m / 135 m  
 Wind zone (DIBT): WZ III  
 Wind class (IEC): IEC/NVN IIA

**WEC concept:** Gearless, variable speed  
 Single blade adjustment

**Rotor**  
 Type: Upwind rotor with active pitch control  
 Rotational direction: Clockwise  
 No. of blades: 3  
 Swept area: 8,012 m<sup>2</sup>  
 Blade material: GRP (epoxy resin);  
 Built-in lightning protection  
 Rotational speed: Variable, 4–14.5 rpm  
 Pitch control: ENERCON single blade pitch system;  
 one independent pitch system per rotor blade with allocated emergency supply

**Drive train with generator**  
 Hub: Rigid  
 Main bearing: Double-row tapered/cylindrical roller bearings  
 Generator: ENERCON direct-drive annular generator  
**Grid feed:** ENERCON inverter  
**Brake systems:** – 3 independent pitch control systems with emergency power supply  
 – Rotor brake  
 – Rotor lock, latching (15°)  
**Yaw system:** Active via yaw gear, load-dependent damping  
**Cut-out wind speed:** 28–34 m/s (with ENERCON storm control\*)  
**Remote monitoring:** ENERCON SCADA

\*For more information on the ENERCON storm control feature, please see the last page.

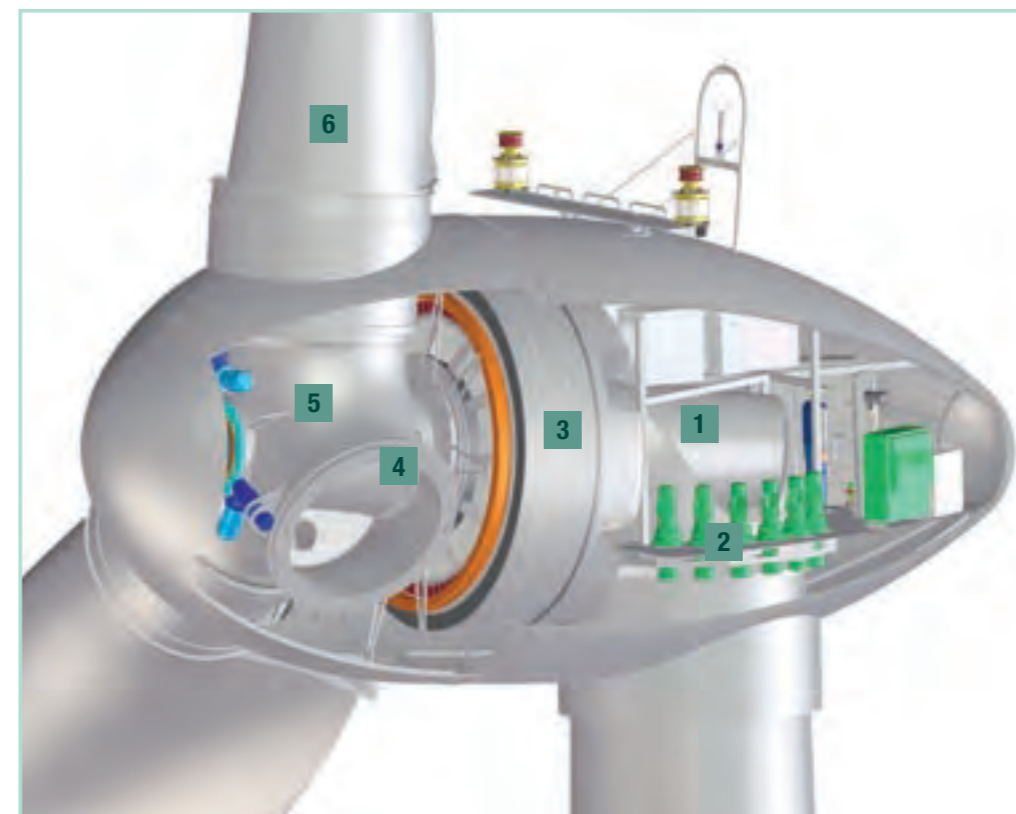

- 1 Main carrier
- 2 Yaw drive
- 3 Annular generator
- 4 Blade adapter
- 5 Rotor hub
- 6 Rotor blade



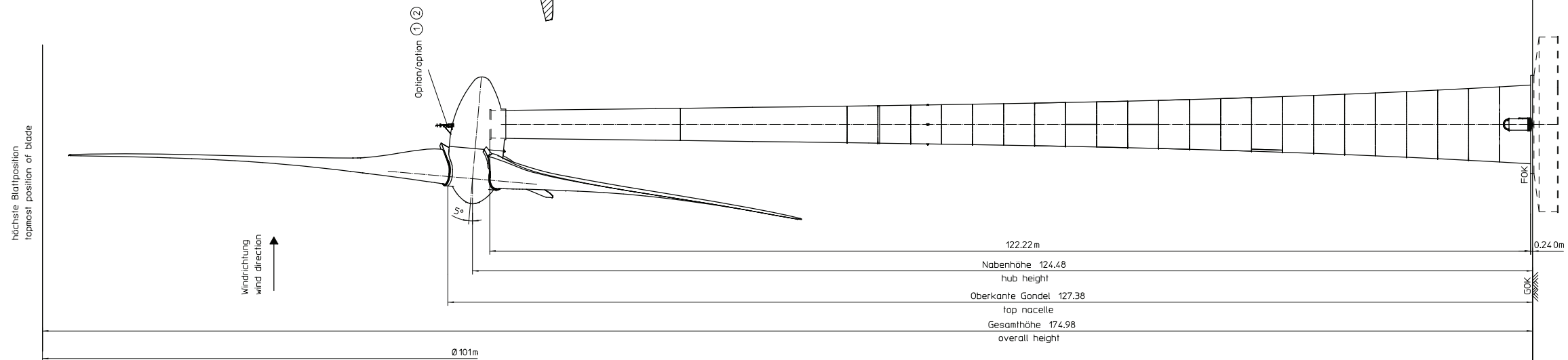
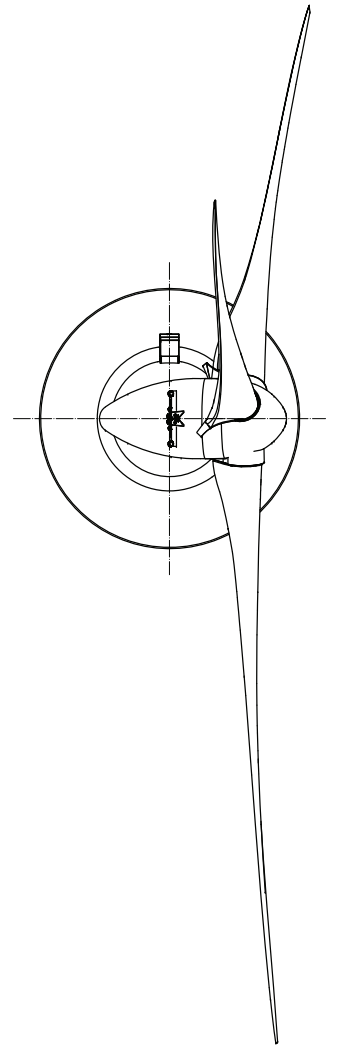
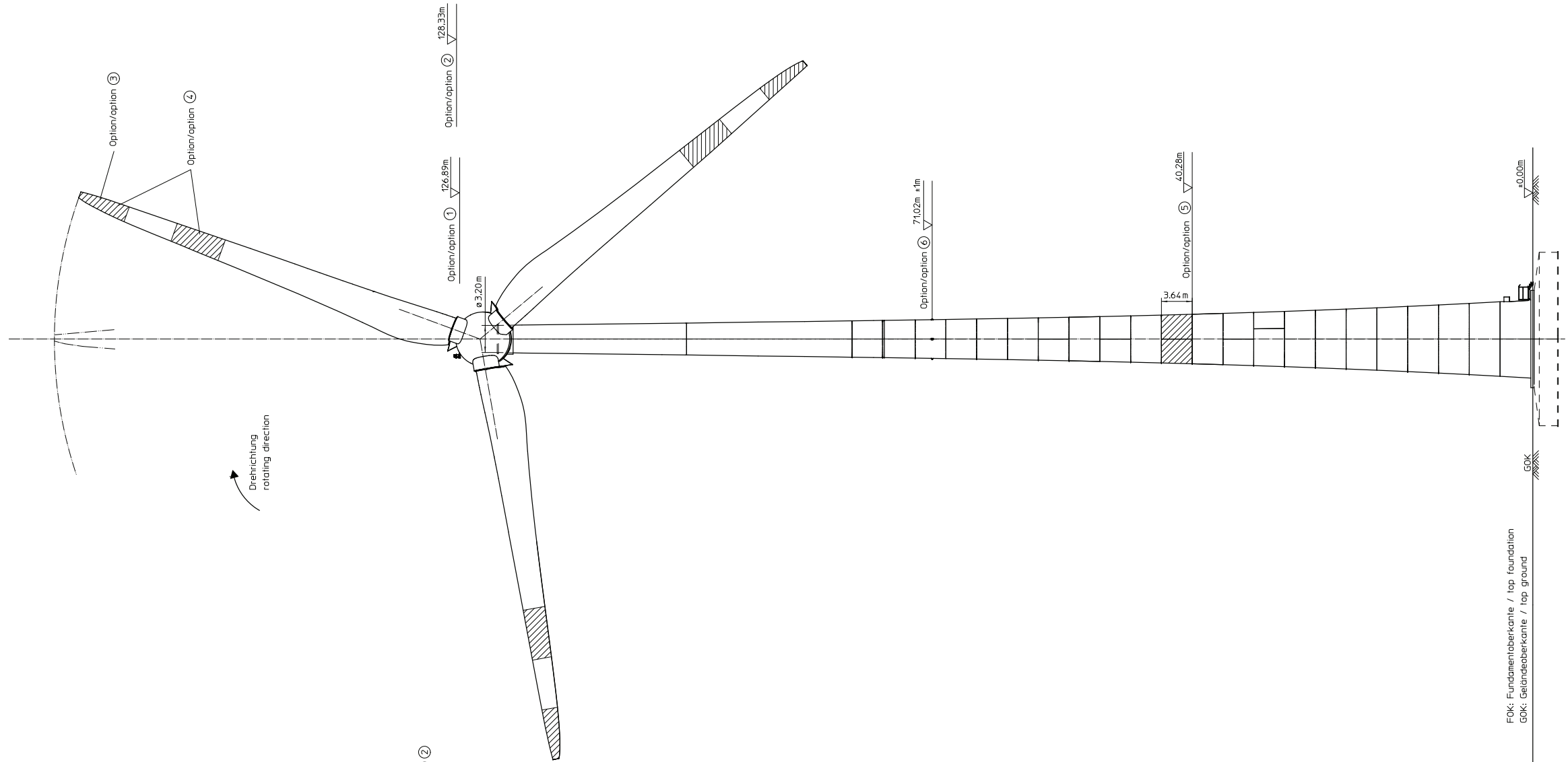

Projektbezogene Angaben / project specific data	
Projekt / project:	
Geländehöhe über NN / ground height above sea level:	
Gesamthöhe über NN / total height above sea level:	
Optionen / options:	
① Nachtkennzeichnung / night marking:	W - Rot / W - Red
② Tageskennzeichnung / daylight marking:	weißes Blitzlicht mit Sichtweitenreduzierung white flashlight with visibility reduction
③ Tageskennzeichnung / daylight marking:	6m rot (RAL 3020) / graues Rotorblatt (RAL 7038) / 6m red (RAL 3020) / grey rotor blade (RAL 7038)
④ Tageskennzeichnung / daylight marking:	rot/grau/rot (RAL 3020 / RAL 7038 / RAL 3020) je 6m lang / red/grey/red (RAL 3020 / RAL 7038 / RAL 3020) every 6m long
⑤ Tageskennzeichnung / daylight marking:	3.83m Farbfeld RAL 3020 / 3.83m colour field RAL 3020
⑥ Nachtkennzeichnung / night marking:	Hindernisse auf jeder Turmachse 10CD / obstruction fire on every tower axis 10CD

Statisch und Konstruktiv  
nicht geprüft

ENERCON GmbH Druckring 5 24249 Aursten Germany		Allgemeinreferenz: 01.00.002		Skizze 1:200		Gezeichnet 08.07.2010		Name Stierlert		Ansicht Betonfertigteilturm View Precast Concrete Tower E-101 E1/BF/125/▲	
WRO-Turm		101.00.008 - 0		Blatt 1		Standort DE		Skala 1:1		© 1974/2009	

Entwurf /  
Drafting

## WIND ENERGY CONVERTER CHARACTERISTICS E-101

<b>Rotor</b>	
Type	E-101
Rotor diameter	101 m
Swept area	8012 m <sup>2</sup>
Power regulation	Pitch
RPM	4 – 14,5 min <sup>-1</sup>
Cut in wind	2,5 m/s
Cut out wind	28 – 34 m/s
Survival wind speed	59,5 m/s

<b>Gear Box</b>	
Not applicable	No gearbox

<b>Blades</b>	
Manufacturer	ENERCON
Blade length	48,5 m
Material	GRP (Epoxy)
Lightning protection	included

<b>Generator</b>	
Manufacturer	ENERCON
Nominal Power	3000 kW
Type (model)	Synchronous, direct-drive ringgenerator
Protection classification	IP 23
Insulation class	F

<b>Yaw System</b>	
Type	electrical motors
Yaw control	Active (based on wind vane signal)
Yaw rate	0,5°/sec

<b>Controller</b>	
Manufacturer	ENERCON
Type	microprocessor
Grid connection	Via ENERCON inverter
Remote communication	ENERCON Remote Monitoring System
UPS	included

<b>Braking System</b>	
Aerodynamic brake	<ul style="list-style-type: none"> <li>- three independent blade pitch systems with emergency supply</li> <li>- rotor brake</li> <li>- rotor lock, locking at 30°</li> </ul>

<b>Tower</b>			
Hub heights	99 m	135 m	
Tower	Prefab concrete	Prefab concrete	
Design Wind Class	<b>IIA</b>	<b>IIA</b>	

Sources: Design Assessment

© by ENERCON GmbH. All rights reserved.			
Created/Date:	M. Lüninghöner	Checked:	AH/09/2009
Dpt.:	SL_HB	Approved:	SL_HB_WEC Characteristics_E-101_Rev001_eng-eng.doc
Revision:	001/31.03.2010	Reference :	

## Prevention

All mechanical and electrical components of the wind energy converter in which overheating or short circuits could potentially ignite a fire are permanently monitored by sensors – primarily to ensure their proper functioning – while the WEC is running. If the WEC control system detects irregularities, the wind energy converter stops or continues with limited power. This function is the most effective component of the fire safety system.

## Components

Special fire safety components of the E-70 E4 include:

- One Hekatron ORS 142 smoke detector (see appendix for data sheet) on the rotor head side of the stator support ring
- One Hekatron ORS 142 smoke detector on the machine house side of the stator support ring
- One Hekatron ORS 142 smoke detector on the bottom side of the main carrier (i.e., at the tower top)
- One hand-held CO<sub>2</sub> fire extinguisher in the nacelle
- If required by national regulations, one hand-held CO<sub>2</sub> fire extinguisher in the tower base (ENERCON personnel carry an additional fire extinguisher in their Service vehicles)
- Fire retardant or hardly inflammable or incombustible materials for specific components.



No smoke detectors are installed inside the tower and in the tower base. Since the WEC cooling system transports air from the tower base to the area above the tower top at high speed, the smoke detectors in the nacelle are able to detect a fire in the tower or the tower base.

## Safe stopping of the wind energy converter in hazardous situations

The emergency pitch unit of each rotor blade consists of blade relay box, capacitor box, and pitch motor. If a safety-relevant sensor reports a fault or a safety switch is triggered, the wind energy converter stops immediately. The pitch control boxes disconnect the pitch motors from the control system and switch the contactors in the blade relay boxes to power supply by the capacitor boxes. The rotor blades automatically move into feathered position independently of each other until switched off by limit switches on the blade bearings. In case of an emergency stop of the rotor (in the event of a fire) an additional electromechanical brake is used. Decelerating the rotor from its rated speed to a standstill takes 10 to 15 seconds.

### Fire during WEC operation

There are no persons present in the wind energy converter while it is running. If a fire is detected the rotor of the WEC stops as quickly as possible (emergency stop). The smoke detectors and/or temperature sensors generate signals that are immediately forwarded by the SCADA remote monitoring system to ENERCON Service, who in turn will immediately alert the local fire service and the utility operating the grid. They decide on site which measures are required. The ENERCON Service Center is staffed 24/7 and can thus be contacted at any time

### Fire while persons are present

In this scenario, follow the instructions and rules of conduct below.

- Stop the wind energy converter and turn off the main switch, if still possible. Otherwise, push the EMERGENCY STOP button.
- Call the fire service.
- Rescue any injured persons from the danger zone and ensure first aid is provided.
- Use carbon dioxide fire extinguishers to fight the fire; follow the operating instructions of the fire extinguishers. Only try to fight the fire if you can do so without putting your own safety at risk and if the escape route is clear.
- If the fire cannot be extinguished immediately, do not continue fire fighting efforts. Evacuate the wind energy converter and any ancillary buildings, and leave the WEC. Cordon off a wide area around the WEC.
- If it is no longer possible to descend safely in the tower, climb up into the nacelle and use rescue equipment (abseiling device) to leave the nacelle through the winch hatch.
- Notify the technical manager of the relevant utility company.
- Clear access roads for emergency services.
- Notify ENERCON Service.



If the *Maintenance* status has been activated during service work on the wind energy converter, any signals generated by smoke detectors and other sensors are **not** transmitted to ENERCON Service.

### Maintenance

In the event of a SCADA system fault a corresponding message is sent to the ENERCON Service Center that will then initiate troubleshooting measures at once. The smoke detectors and the SCADA system are inspected in the setting of the annual electrical maintenance. Inspection and maintenance of fire extinguishers is performed in accordance with national regulations.

## Optischer Rauchschalter ORS 142

## Détecteur de fumée optique ORS 142

## ORS 142 optical smoke switch

- optische Rauchererkennung
- Verschmutzungsanzeige
- Alarmschwellennachführung
- kommunikationsfähig
- Meßkammerüberwachung
- potentialfreier Öffner

- détection de fumée optique
- indicateur de colmatage
- correction du seuil d'alarme
- communication
- surveillance par chambre de mesure
- contact d'ouverture exempt de potentiel

- Optical smoke detection
- Contamination warning
- Auto contamination compensation
- Communications capability
- Sensing chamber monitoring
- NC volt-free contact

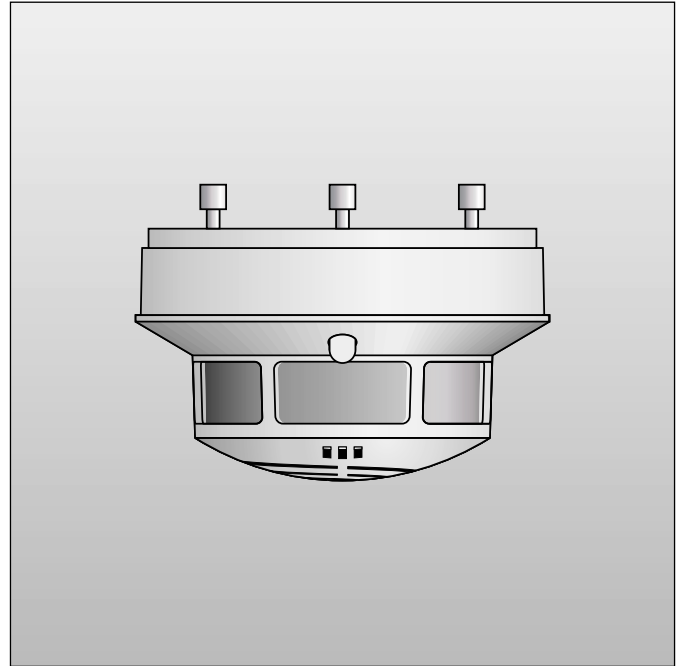

Der optische Rauchschalter ORS 142 erkennt frühzeitig sowohl Schwelbrände als auch offene Brände mit Rauchentwicklung. Ein zusätzlicher Temperaturfühler spricht bei einer Umgebungstemperatur von 70 °C an. Er wird vorzugsweise in Feststellanlagen und maschinellen Rauchabzugsanlagen eingesetzt. Der ORS 142 löst den bisherigen Rauchschalter ORS 132 ab.

Le détecteur de fumée optique ORS 142 décèle rapidement aussi bien les feux couvants que les feux déclarés avec émission de fumée.

Un capteur thermique supplémentaire se déclenche automatiquement à partir d'une température ambiante de 70°C.

Ce dispositif s'utilise de préférence pour les contrôles automatiques des portes et systèmes de désenfumage mécaniques

The ORS 142 optical smoke switch reacts promptly to smouldering fires as well as to flaming fires that develop smoke. An additional temperature sensor is triggered at an ambient temperature of 70 °C.

Its principal application is for door holder/closer systems and powered smoke ventilation systems.

Der ORS 142 arbeitet nach dem Streulichtprinzip. Lichtsender und -empfänger sind in der Meßkammer so angeordnet, daß das Licht des Senders den Empfänger nicht direkt trifft. Erst das an Schwebeteilchen gestreute Licht gelangt zum Empfänger.

Die Auswerteelektronik des ORS 142 überwacht den Rauchmeßteil des Melders zusätzlich auf leichte Verschmutzung, starke Verschmutzung und Störung (Meßkammerausfall).

Die jeweiligen Betriebszustände zeigt der ORS 142 optisch an.

Eine Langzeit-Alarmschwellennachführung sorgt für einen gleichbleibenden Abstand zwischen Grundsignal und Alarmschwelle, bis der Grenzwert für starke Verschmutzung erreicht ist.

Ein Relaiskontakt öffnet bei Alarm sowie bei Spannungsausfall.

### Kommunikation

Der ORS 142 meldet seinen Funktionszustand über Stift 3 an eine RZA 142 (Rauchschalter-Zustandsanzeige). Hier werden ebenfalls die Zustände mit farbigen LEDs optisch angezeigt.

Wird der ORS 142 an ein RSI (Rauchschalter-Interface) angeschlossen, können die Melderzustände mit einem PC abgefragt werden. Mit einem Modem können RSI und PC über eine Postleitung kommunizieren.

L'ORS 142 fonctionne sur le principe de la lumière diffuse. L'émetteur et le récepteur de lumière sont positionnés dans la chambre de mesure de manière que la lumière provenant de l'émetteur ne parvienne pas directement au récepteur, mais seulement sous forme de lumière diffusée sur les particules en suspension.

L'unité d'évaluation électronique de l'ORS 142 surveille le dispositif de mesure de fumée du détecteur afin de déceler l'encrassement, faible ou important, ainsi que les pannes (défaillances de la chambre de mesure). Les états de fonctionnement de l'ORS 142 sont signalés de manière optique. Le dispositif de correction du seuil d'alarme assure un écart constant entre le signal de base et le seuil d'alarme, et ceci jusqu'à ce que la valeur limite d'encrassement important soit atteinte.

Un contact de relais s'ouvre en cas d'alarme ou d'absence de courant.

### Communication

L'ORS 142 signale son état de fonctionnement au niveau de l'ergot 3 de l'indicateur de fonctionnement RZA 142. Des DEL de couleur signalent également les états de fonctionnement de manière optique. Lorsque l'ORS 142 est branché sur une interface de détecteur de fumée, il est possible de vérifier l'état de fonctionnement du détecteur à partir d'un PC. À l'aide d'un modem, l'interface et le PC peuvent communiquer par une ligne téléphonique.

The ORS 142 operates on the light scatter principle. Inside the sensing chamber a light source and a light sensor are arranged so that the light normally does not fall on the sensor. It is only when airborne particles enter the chamber that light is scattered onto the sensor.

The ORS 142 electronic circuitry also monitors the smoke detection system for slight contamination (dust and dirt build-up), heavy contamination and faults (sensing chamber failure). LEDs provide an optical indication of the operating status of the ORS 142. A long-term compensation function automatically maintains a constant difference between the quiescent signal and the alarm threshold, until a set limit indicating heavy contamination is reached.

A relay contact opens in the alarm condition or on power failure.

### Communications

The ORS 142 signals its functional status via pin 3 to an RZA 142 smoke switch status indicator, whose coloured LEDs give an additional remote optical indication of the instrument's condition.

If the ORS 142 is linked to an RSI smoke switch interface, detector status can be scanned from a PC. The RSI and the PC can also communicate over a telecommunications line.

### DIBt-Zulassungen für:

Feststellanlagen	Z-6.5-1571 Z-6.5-1725
maschinelle Rauchabzugsanlagen	Z-78.5-15

### Homologations DIBt pour :

Équipements coupe-feu	Z-6.5-1571 Z-6.5-1725
Systèmes de désenfumage mécaniques	Z-78.5-15

### DIBt approvals for:

Hold-open systems	Z-6.5-1571 Z-6.5-1725
Powered smoke ventilation systems	Z-78.5-15

## Technische Daten/Caractéristiques techniques/Technical data

nach/selon/to EN 54, Teil 7	Rauch	Fumée	Smoke
70 °C	Temperatur	Température	Temperature
18 bis/à/to 28 VDC	Betriebsspannung	Tension de service	Operating voltage
	Stromaufnahme bei 28 V <sub>DC</sub>	Consommation pour 28 V <sub>DC</sub>	Current draw at 28 V DC
max. 21 mA	in Ruhe	au repos	quiescent
max. 10 mA	bei Alarm	en cas d'alarme	in alarm
max. 25 mA	bei Störung	en cas de défaillance	in fault
Öffner/contact d'ouverture/NC	Relaiskontakte	Contacts de relais	Relay contact
max. 30 VDC	Schaltspannung	Tension d'enclenchement	switched voltage
max. 1 A	Schaltstrom	Courant d'enclenchement	switched current
max. 30 W	Schaltleistung	Puissance de rupture	switched power
IP 42	Schutzart	Indice de protection	Ingress protection
-20 bis/à/to +80 °C	Betriebsumgebungstemperatur	Température ambiante d'exploitation	Ambient operating temperature
120 g	Gewicht	Poids	Weight

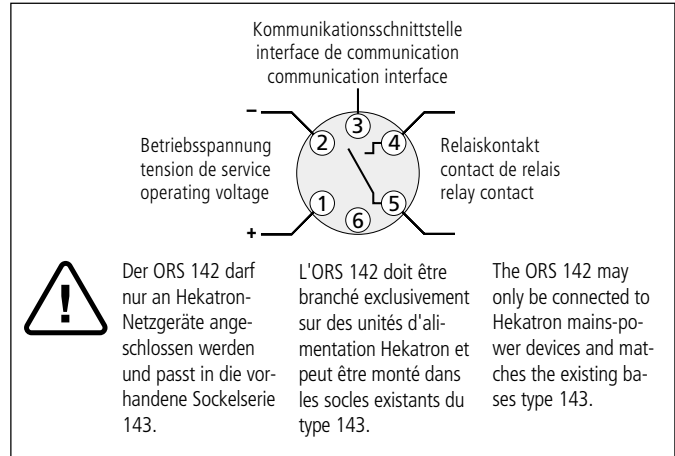
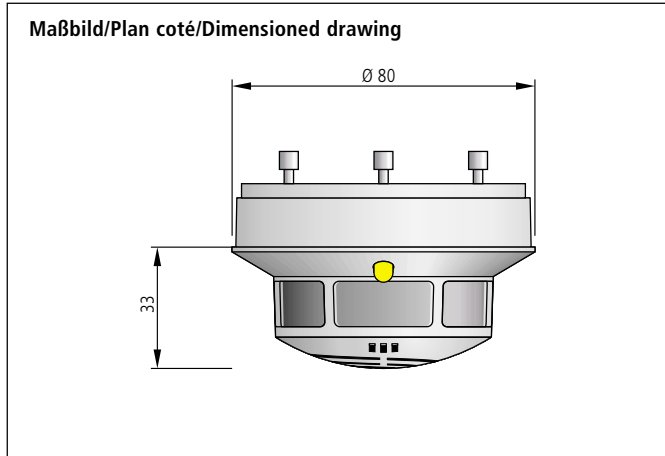

### Relais/Relais/Relay

### Einzelanzeige/Affichage individuel/LED

Betrieb en service in operation		grün/vert/green	—
leicht verschmutzt légèrement encrassé slight contamination		grün/vert/green	
stark verschmutzt encrassé heavy contamination		grün/vert/green	
Störung défaillance fault		gelb/jaune/yellow	—
Alarm alarme alarm		rot/rouge/red	—
spannungslos hors tension power off		dunkel/sombre/dark	—

### Bestelldaten/Références/Ordering data

5 000 552	ORS 142	Rauchschalter, weiß nach RAL 9010	Détecteur de fumée, blanc RAL 9010	Smoke switch, white (DIN shade RAL 9010)
		andere Farben auf Anfrage	autres couleurs sur demande	other colours on request

Technische Änderungen sowie Liefermöglichkeiten vorbehalten.

Sous réserve de modifications techniques ainsi que de possibilités de livraison.

Specifications subject to change without notice. Delivery subject to availability.

www.hekatron.de  
info@hekatron.de

**HEKATRON Vertriebs GmbH**  
Brühlmatten 9  
**D-79295 Sulzburg**  
Telefon (07634) 500-264  
Telefax (07634) 500-323

**HEKATRON**  
Sicherheitssysteme

Ein Unternehmen der  
**Schweizer Securitas Gruppe**

Une entreprise du  
**Groupe suisse Securitas**

A member of the  
**Swiss Securitas Group**



## WIND ENERGY CONVERTER CHARACTERISTICS E-101

<b>Rotor</b>	
Type	E-101
Rotor diameter	101 m
Swept area	8012 m <sup>2</sup>
Power regulation	Pitch
RPM	4 – 14,5 min <sup>-1</sup>
Cut in wind	2,5 m/s
Cut out wind	28 – 34 m/s
Survival wind speed	59,5 m/s

<b>Gear Box</b>	
Not applicable	No gearbox

<b>Blades</b>	
Manufacturer	ENERCON
Blade length	48,5 m
Material	GRP (Epoxy)
Lightning protection	included

<b>Generator</b>	
Manufacturer	ENERCON
Nominal Power	3000 kW
Type (model)	Synchronous, direct-drive ringgenerator
Protection classification	IP 23
Insulation class	F

<b>Yaw System</b>	
Type	electrical motors
Yaw control	Active (based on wind vane signal)
Yaw rate	0,5°/sec

<b>Controller</b>	
Manufacturer	ENERCON
Type	microprocessor
Grid connection	Via ENERCON inverter
Remote communication	ENERCON Remote Monitoring System
UPS	included

<b>Braking System</b>	
Aerodynamic brake	<ul style="list-style-type: none"> <li>- three independent blade pitch systems with emergency supply</li> <li>- rotor brake</li> <li>- rotor lock, locking at 30°</li> </ul>

<b>Tower</b>			
Hub heights	99 m	135 m	
Tower	Prefab concrete	Prefab concrete	
Design Wind Class	<b>IIA</b>	<b>IIA</b>	

Sources: Design Assessment

© by ENERCON GmbH. All rights reserved.			
Created/Date:	M. Lüninhöner	Checked:	AH/09/2009
Dpt.:	SL_HB	Approved:	SL_HB_WEC Characteristics_E-101_Rev001_eng-
Revision:	001/31.03.2010	Reference :	eng.doc

# FUNDAMENT-DATENBLATT FOUNDATION DATA SHEET

## E-101/BF/133/27/01

WZ III (DIBt- Richtlinie Fassung 2004, Anhang B)  
WZ 4; GK I (DIN 1055-4: 2005-03)  
WTC II A (IEC 61400-1, 3rd edition, 2005-08)  
WEA-Klasse II A (DIN EN 61400-1, 2006-07)

Bauteil: **Fundament- Flachgründung ohne Auftriebswirkung**  
Component: **Foundation – Flat Foundation without Buoyancy**

8107894074-7 E I

**Reviewed**  
Essen, 20. April 2011  
*S. Möller*  
S. Möller Expert of  
TÜV NORD SysTec GmbH & Co. KG

**TÜV NORD**  
20. APR. 2011

This document has been forwarded upon request or with regard to a specific order. The recipient has not been registered. The recipient will not be automatically notified about any amendments.

Any copying and disclosure to third parties require the permission of ENERCON GmbH.

<b>Document information:</b>		© Copyright ENERCON GmbH. All rights reserved.	
Author/ date:	MFE / 2011-02-09	Translator / date:	-
Department:	WRD-K	Revisor / date:	-
Approved / date:	TE / 2011-02-09	Reference:	WRD-K-04-FDB-FEB-E-101_BF_133_27_01-Rev_1-EN
Revision / date:	MFE 1 / 2011-03-14		

## 1.0 General information

Design-specific structural analysis:

 Structural calculation by ENERCON GmbH,  
 E-101/BF/133/27/01  
 Flat foundation without buoyancy –  $\varnothing$  20.90 m  
 Revision 1 – 14.03.2011

## 2.0 Foundation dimensions

Outer diameter	$d_a$	20.90 m
Inner diameter	$d_i$	11.20 m
Base diameter – outside	$d_{so,a}$	13.50 m
Base diameter – inside	$d_{so,i}$	8.50 m
Foundation height	$h_{ges}$	3.10 m
Base height	$h_{so}$	0.40 m
Spur incline height	$h_n$	0.60 m
Spur height	$h_{sp}$	2.10 m
Difference between foundation top edge and ground level	$h_{gok}$	0.20 m
Concrete quality and volume	C 30/37	677 m <sup>3</sup>
Reinforcement steel and weight	B 500B	68.6 t

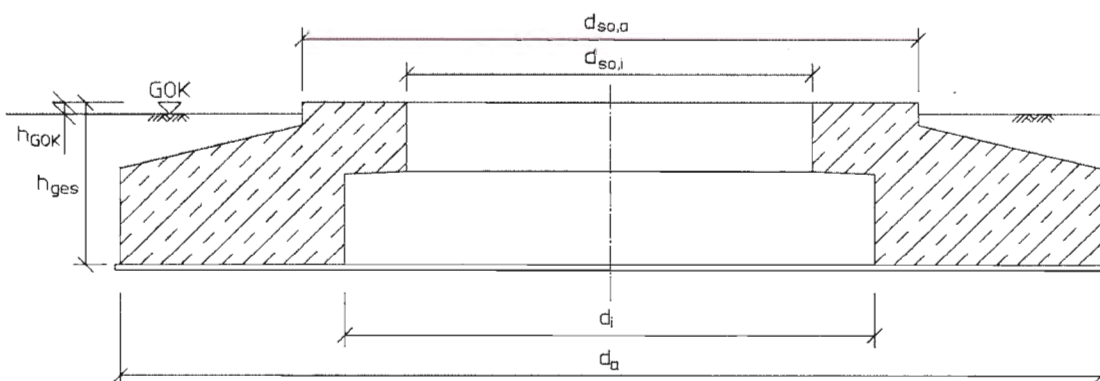

**TUV NORD**  
 20. APR. 2011

**Document information:**

 Author / date: MFE / 2011-02-09  
 Department: WRD-K  
 Approved / date: TE / 2011-02-09  
 Revision / date: MFE 1 / 2011-03-14

© Copyright ENERCON GmbH. All rights reserved.

 Translator / date:  
 Revisor / date:  
 Reference:

WRD-K-04-FDB-FEB-E-101\_BF\_133\_27\_01-Rev\_1-EN

### 3.0 Minimum rocking spring stiffness

Observe the following minimum values with regard to elastic clamping between foundation and subsoil:

<b>Total system</b> (tower and foundation)	<b><math>k_{\phi,stat}</math></b> <b>15000 [MNm/rad]</b>
	<b><math>k_{\phi,dyn}</math></b> <b>150000 [MNm/rad]</b>

The resulting required dynamic stiffness moduli ( $E_{oed,dyn}$ ) depend on the foundation dimensions and Poisson's ratio.

Equivalent radius of a circle with the same stiffness:

$$r = 10.23 \text{ m}$$

The following applies to circular foundations:

$$k_{\phi} = \frac{8 \cdot G \cdot r^3}{3 \cdot (1 - \nu)}$$

This means that

$$E_{oed,dyn} = k_{\phi} \cdot \frac{3}{4} \cdot \frac{1}{r^3} \cdot \frac{(1 + \nu) \cdot (1 - \nu)^2}{1 - \nu - 2 \cdot \nu^2} \quad \text{where}$$

$G$  = shear modulus  
 $r$  = radius  
 $\nu$  = Poisson's ratio

### 4.0 Allowed inclination

Maximum allowed inclination due to subsoil settlement within 20 years, related to the outer diameter.

$$\Delta s \leq 40 \text{ mm}$$

### 5.0 Soil bearing pressure

The in-situ subsoil must be able to bear a minimum pressure of  $\sigma_{k,vorh} = 401 \text{ kN/m}^2$ .



**TUV NORD**  
 20. APR. 2011

<b>Document information:</b>		© Copyright ENERCON GmbH. All rights reserved.	
Author / date:	MFE / 2011-02-09	Translator / date:	-
Department:	WRD-K	Revisor / date:	-
Approved / date:	TE / 2011-02-09	Reference:	WRD-K-04-FDB-FEB-E-101_BF_133_27_01-Rev_1-EN
Revision / date:	MFE 1 / 2011-03-14		

## 6.0 Loads at the bottom edge of the foundation

The  $F_z$  loads indicated include the dead weight of the foundation  $\gamma = 25 \text{ kN/m}^3$  and soil weight  $\gamma = 18 \text{ kN/m}^3$  when dry.

### 6.1 Characteristic load cases

Load case	( $\gamma_{aero}/\gamma_{mass}$ )	$F_{xy}$ [kN]	$F_z$ [kN]	$M_{xy}$ [kNm]	$M_z$ [kNm]
DLC 1.0	(1.00/1.00)	1100	-36707	103954	-
DLC 3.2	(1.00/1.00)	1470	-36790	153801	-8420
DLC 6.2	(1.00/1.00)	1700	-36590	189565	-8590

Loads do not include partial safety factor ( $\gamma_F = 1.0$ )

### 6.2 Load case design values

Load case	( $\gamma_{aero}/\gamma_{mass}$ )	$F_{xy}$ [kN]	$F_z$ [kN]	$M_{xy}$ [kNm]	$M_z$ [kNm]
DLC 3.2	(1.35/1.35)	2110	-49067	217115	-11600
DLC 3.2	(1.35/1.00)	2110	-36808	217115	-11600

All loads include partial safety factors

## 7.0 Coordinate system

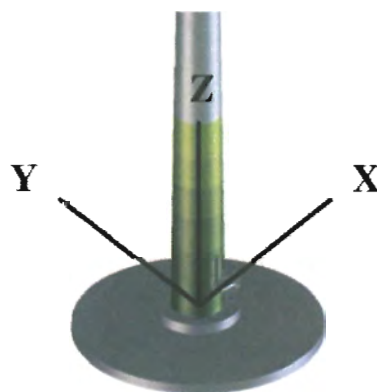

In der folgenden Tabelle sind die Gewichte der Transport- und Aufbaueinheiten der E-101 angegeben. Es ist zu beachten, dass es sich dabei um ca.-Angaben handelt. Bei den Einzelgewichten sind jeweils die notwendigen Transport- und Aufbauvorrichtungen berücksichtigt, das angegebene Gondelgesamtwicht entspricht der Turmkopfmasse nach Fertigstellung der Anlage.

In the following table the weights of the transport and installation component-assemblies of the E-101 are given. It is to be noted that the values are approximated. The weights include the necessary transport and installation devices, the given value for overall nacelle weight corresponds to the tower head mass after completion of the turbine.

Transport	Transport		
Rotorblatt mit HKS	Rotor blade with fin	ca. 21,0	t
3x HKS	3x Fin	ca. 2,4	t
Rotornabe	Rotor hub	ca. 50,0	t
Generator	Generator	ca. 83,0	t
Gondel (Maschinenträger etc.)	Nacelle (main carrier etc.)	ca. 59,0	t
Aufbau	Installation		
Rotornabe (incl. Rotorblätter)	Rotor hub (incl. rotor blades)	ca. 115,0	t
Generator	Generator	ca. 84,0	t
Generator-Stator	Generator stator	ca. 52,0	t
Generator-Rotor	Generator rotor	ca. 35,0	t
Gondel (Maschinenträger etc.)	Nacelle (main carrier etc.)	ca. 59,0	t
Gondelgesamtwicht	Overall nacelle weight	ca.255,0	t

© Copyright ENERCON GmbH. Alle Rechte vorbehalten.



# Sound Power Level of the ENERCON E-101 3.0 MW

**Publisher:**

ENERCON Canada Inc.  
1000, rue de La Gauchetière ouest Bureau 2310  
Montréal, QC, H3B 4W5  
+1 514 ENERCON (+1 514 363 7266)

**Copyright:**

© ENERCON Canada Inc. Any reproduction, distribution and utilisation of this document as well as the communication of its contents to third parties without express authorisation is prohibited. Violators will be held liable for monetary damages. All rights reserved in the event of the grant of a patent, utility model or design.

**Content subject to change:**

ENERCON Canada Inc. reserves the right to change, improve and expand this document and the subject matter described herein at any time without prior notice.

Author/date:	H.Shahriar /15.06.12	Translator/date:	N.Nnnn / DD.MM.YY
Department:	Sales	Revisor/date:	H.Shahriar / 28.05.13
Approved/date:	E. DeGroot/29.05.13	Reference:	Annex 12 Sound Power Level E-101d
Released/date:	H.Shahriar /29.05.13		

The following represents the maximum sound power level of the E-101 3.0 MW for the entire operational range of wind speeds in accordance with the measurement technique IEC 61 400 – 11:2002 and A1:2006.

### Sound Power Level for the E-101 with 3.0 MW rated power

<b>Hub Height</b>	<b>124m</b>	<b>135m</b>
<b>95% rated power</b>	<b>104.8 dB(A)</b>	<b>104.8 dB(A)</b>

1. A tonal audibility of  $\Delta L_{a,k} \leq 2 \text{ dB}$  can be expected over the whole operational range and is valid in the near vicinity of the turbine according to IEC 61 400 -11 ed. 2.
2. Sound power level values provided in the table are valid for the **Operational Mode I**. The respective power curve is the calculated power curve E-101 dated October 2009 (Rev 2.0).
3. Due to typical measurement uncertainties, if the sound power level is measured according to the accepted method, the measured values can differ from the values shown in this document in the range of +/- 1dB.

Accepted measurement method:

IEC 61400-11 ed.2 (“Wind turbine generator systems – Part 11: Acoustic noise measurement techniques; Second edition, 2002 – 12”).

If the difference between tonal noise and background noise during a measurement is less than 6 dB, a higher uncertainty must be considered.

4. The sound power level of a wind turbine depends on several factors such as, but not limited to, regular maintenance and day-to-day operation in compliance with the manufacturer’s operating instructions. Therefore, this data sheet cannot, and is not intended to, constitute an express or implied warranty towards the customer that the E-101 WEC will meet the exact sound power level as shown in this document at any project specific site.

Author/date:	H.Shahriar /15.06.12	Translator/date:	N.Nnnn / DD.MM.YY
Department:	Sales	Revisor/date:	H.Shahriar / 28.05.13
Approved/date:	E. DeGroot/29.05.13	Reference:	Annex 12 Sound Power Level E-101d
Released/date:	H.Shahriar /29.05.13		

## Summary of Test Report (Measured hub height of 99 m) /1/

Master Data Sheet "Geräusche" (Noise), in accordance with  
 "Technische Richtlinien für Windenergieanlagen, Teil 1: Bestimmung der Schallemissionswerte"  
 (Technical Guidelines for Wind Turbine Generators, Part 1: Determination of sound emission values)

Rev. 18 of February 1, 2008 (Editor: Fördergesellschaft Windenergie e.V. Stresemannplatz 4, D-24103 Kiel)

Extract of Test Report 213122-02.01 IEC  
 on noise emission of wind turbine generator of type E-101

General Data		Technical Data (manufacturer's specifications)	
Manufacturer of WTG:	Enercon GmbH	Rated power (generator):	3,050 (3,250) kW
Serial number:	1010002	Diameter of rotor:	101 m
Location of WTG (approx.):	49733 Haren	Hub height above ground:	99 m
Geographic co-ordinates:	GK longitude: 25.76.214 GK latitude: 58.59.856	Type of tower:	conical tubular concrete
		Power control:	Pitch
Complementary rotor data (manufacturer's specifications)		Complementary data of gear unit and generator (manufacturer's specifications)	
Manufacturer of rotor blade:	Enercon	Manufacturer of gear unit:	not applicable
Type of rotor blade:	E-101-1	Type of gear unit:	not applicable
Blade setting angle:	variable	Manufacturer of generator:	Enercon
Number of rotor blades:	3	Type of generator:	G-101/30-G2
Rotor speed range:	5 to 14.7 rpm. (mode OM I)	Rated speed of generator:	5 to 14.7 rpm. (mode OM I)

Calculated Performance Chart: Performance characteristic E101 3 MW OM I ; calculated by ENERCON (Rev. 1.0)

	Reference Point		Noise emission parameters	Observations
	standardized wind speed at a height of 10 m	true electrical power		
sound power level $L_{WA,P}$	6 $ms^{-1}$	1,414 kW	103.6 dB(A)	
	7 $ms^{-1}$	2,077 kW	104.3 dB(A)	
	8 $ms^{-1}$	2,751 kW	104.8 dB(A)	
	9 $ms^{-1}$	2,987 kW	104.6 dB(A)	(1)
	10 $ms^{-1}$	3,050 kW	--	(2)
tonal audibility $\Delta L_{a,k}$	6 $ms^{-1}$	1,414 kW	- 1.5 dB	
	7 $ms^{-1}$	2,077 kW	0 dB	
	8 $ms^{-1}$	2,751 kW	0 dB	
	9 $ms^{-1}$	2,987 kW	0 dB	(1)
	10 $ms^{-1}$	3,050 kW	--	(2)
impulse adjustment for immediate vicinity $K_{IN}$	6 $ms^{-1}$	1,414 kW	0 dB	
	7 $ms^{-1}$	2,077 kW	0 dB	
	8 $ms^{-1}$	2,751 kW	0 dB	
	9 $ms^{-1}$	2,987 kW	0 dB	(1)
	10 $ms^{-1}$	3,050 kW	--	(2)

Third-octave band sound power level for $v_s = 6 ms^{-1}$ in dB(A)													
Frequency	50	63	80	100	125	160	200	250	315	400	500	630	
$L_{WA,P}$	78.3	81.8*	83.0**	84.2	89.6	85.7*	89.2	92.7	94.1	94.6	95.1	94.9	
Frequency	800	1,000	1,250	1,600	2,000	2,500	3,150	4,000	5,000	6,300	8,000	10,000	
$L_{WA,P}$	93.5	91.6	90.0	89.0	85.4	84.1	82.3	79.3	74.8	67.8*	64.7**	65.3**	

Octave band sound power level for $v_s = 6 ms^{-1}$ in dB(A)								
Frequency	63	125	250	500	1,000	2,000	4,000	8,000
$L_{WA,P}$	85.6*	91.9	97.2	99.6	96.7	91.5	84.6	70.3*

Third-octave band sound power level for $v_s = 7 ms^{-1}$ in dB(A)													
Frequency	50	63	80	100	125	160	200	250	315	400	500	630	
$L_{WA,P}$	78.9	83.3	84.0	84.9	88.2	86.4*	89.6	94.7	94.9	95.4	95.8	95.5	
Frequency	800	1,000	1,250	1,600	2,000	2,500	3,150	4,000	5,000	6,300	8,000	10,000	
$L_{WA,P}$	94.0	92.0	90.4	89.3	86.1	84.7	82.9	79.9	74.4*	68.4*	64.6**	62.7**	

Octave band sound power level for $v_s = 7 ms^{-1}$ in dB(A)								
Frequency	63	125	250	500	1,000	2,000	4,000	8,000
$L_{WA,P}$	87.3	91.5	98.4	100.3	97.1	91.9	85.0	71.5**

Third-octave band sound power level for $v_s = 8 \text{ ms}^{-1}$ in dB(A)												
Frequency	50	63	80	100	125	160	200	250	315	400	500	630
$L_{WA,P}$	82.1	82.8	84.4	88.4	86.8	90.1	94.8	95.0	95.6	96.3	96.2	82.1
Frequency	800	1,000	1,250	1,600	2,000	2,500	3,150	4,000	5,000	6,300	8,000	10,000
$L_{WA,P}$	95.0	93.3	91.5	90.4	86.7	85.4	83.7	80.9	75.9	69.7*	67.1**	65.5**
Octave band sound power level for $v_s = 8 \text{ ms}^{-1}$ in dB(A)												
Frequency	63	125	250	500	1,000	2,000	4,000	8,000				
$L_{WA,P}$	86.3	91.6	98.6	100.8	98.3	92.8	86.0	73.3**				
Third-octave band sound power level for $v_s = 9 \text{ ms}^{-1}$ in dB(A)												
Frequency	50	63	80	100	125	160	200	250	315	400	500	630
$L_{WA,P}$	78.6	81.9	82.4*	83.9	87.8	85.9*	88.6	93.8	94.2	95.1	96.0	96.3
Frequency	800	1,000	1,250	1,600	2,000	2,500	3,150	4,000	5,000	6,300	8,000	10,000
$L_{WA,P}$	95.4	93.8	92.3	91.0	87.4	86.0	84.1	81.1	76.7	71.7	68.4	66.8*
Octave band sound power level for $v_s = 9 \text{ ms}^{-1}$ in dB(A)												
Frequency	63	125	250	500	1,000	2,000	4,000	8,000				
$L_{WA,P}$	86.0	90.8	97.6	100.6	98.8	93.5	86.4	74.2				

This summary of the test report is valid only in combination with the manufacturer's certificate dated 12/03/2013.

**These specifications do not replace the test report mentioned above (particularly for noise immission predictions).**

- Observations:
- (1) Maximum value of standardized wind speed during the WTG-operation measurement  $v_s = 8,9 \text{ m/s}$
  - (2) Due to weather conditions, no data available during WTG operation
- \* Difference between working and background noise < 6 dB, correction by 1.3 dB  
 \*\* Difference between working and background noise < 3 dB, values shall not be presented

/1/ Wind turbine generator systems – Part 11: Acoustic noise; measurement techniques (IEC 61400-11:2002 and A1:2006); German version DIN EN 61400-11:2007

Measured by: KÖTTER Consulting Engineers  
- Rheine -



Dipl.-Ing. Oliver Bunk      Matthias Humpohl, B.Sc.

Date: 23/04/2013

**Stantec**

**NIAGARA REGION WIND FARMACOUSTIC ASSESSMENT REPORT – REA AMENDMENT**

Appendix E Sample Calculations and CADNA/A Inputs/Outputs  
(In the Attached CD)

October 02, 2015

**Appendix E Sample Calculations and CADNA/A Inputs/Outputs  
(In the Attached CD)**

---

## Receiver

Name: H1BIRD3890  
 ID: O\_1153  
 X: 621067.4  
 Y: 4749725.2  
 Z: 180.6

Name	ID	X (m)	Y (m)	Z (m)	Dist (m)	Refl.	DEN	Freq. (Hz)	Lw dB(A)	I/a dB	K0 (dB)	Dc (dB)	Adiv (dB)	Aatm (dB)	Agr (dB)	Afol (dB)	Ahous (dB)	Abar (dB)	Cmet (dB)	RL (dB)	Lr dB(A)	
R11TO20	T20	620627.3	4749341.4	300.6	596.1	0	DEN	A	104.8	0	0	0	66.5	1.4	-0.5	0	0	0	0	0	0	37.4
R11TS13	T96	621422.7	4750668.3	299.5	1014.8	0	DEN	A	104.8	0	0	0	71.1	2.2	-0.5	0	0	0	0	0	0	31.9
R11TO63	T63	621609.3	4751032.3	300.4	1420.1	0	DEN	A	104.8	0	0	0	74.0	3.0	-0.4	0	0	0	0	0	0	28.2
R11TO62	T62	621876.7	4751310.9	301.0	1784.4	0	DEN	A	104.8	0	0	0	76.0	3.6	-0.4	0	0	0	0	0	0	25.6
R11TO99 (formally R11TS82)	T99	619207.8	4749223.6	299.0	1929.6	0	DEN	A	104.8	0	0	0	76.7	3.8	-0.4	0	0	0	0	0	0	24.7
R11TO05	T05	621171.0	4747754.0	303.8	1977.7	0	DEN	A	104.8	0	0	0	76.9	3.9	-0.4	0	0	0	0	0	0	24.4
R11TO46	T46	622737.0	4748967.6	302.0	1837.5	0	DEN	A	102.9	0	0	0	76.3	3.7	-0.3	0	0	0	0	0	0	23.3
R11TO47	T47	622482.9	4748446.9	303.3	1911.2	0	DEN	A	102.9	0	0	0	76.6	3.8	-0.3	0	0	0	0	0	0	22.8
R11TO45	T45	623160.0	4748650.4	302.1	2355.6	0	DEN	A	102.9	0	0	0	78.4	4.5	-0.3	0	0	0	0	0	0	20.2
R11TO16	T16	624153.0	4749242.9	300.3	3125.4	0	DEN	A	104.8	0	0	0	80.9	5.6	-0.3	0	0	0	0	0	0	18.6
R11TO14	T14	624137.0	4748807.0	301.1	3206.3	0	DEN	A	104.8	0	0	0	81.1	5.7	-0.3	0	0	0	0	0	0	18.2
R11TO44	T44	624350.0	4748471.0	301.8	3516.2	0	DEN	A	104.8	0	0	0	81.9	6.2	-0.3	0	0	0	0	0	0	17.0
R11TO48	T48	624687.0	4749282.7	300.4	3648.6	0	DEN	A	104.8	0	0	0	82.2	6.3	-0.3	0	0	0	0	0	0	16.5
R11TO43	T43	624815.3	4748952.0	301.1	3828.7	0	DEN	A	104.8	0	0	0	82.7	6.6	-0.2	0	0	0	0	0	0	15.8
R11TO84	T84	622487.1	4753392.7	304.0	3934.7	0	DEN	A	104.8	0	0	0	82.9	6.7	-0.3	0	0	0	0	0	0	15.4
R11TO22	T22	624829.2	4748510.0	302.0	3955.1	0	DEN	A	104.8	0	0	0	82.9	6.7	-0.3	0	0	0	0	0	0	15.4
R11TO89	T89	623216.4	4753159.8	304.0	4053.5	0	DEN	A	104.8	0	0	0	83.2	6.9	-0.3	0	0	0	0	0	0	15.1
R11TO42	T42	619935.0	4753628.0	304.0	4065.7	0	DEN	A	104.8	0	0	0	83.2	6.9	-0.3	0	0	0	0	0	0	15.0
R11TO21	T21	625004.0	4748242.0	302.6	4208.5	0	DEN	A	104.8	0	0	0	83.5	7.1	-0.3	0	0	0	0	0	0	14.6
R11TO61	T61	625177.0	4747970.0	302.9	4470.4	0	DEN	A	104.8	0	0	0	84.0	7.4	-0.3	0	0	0	0	0	0	13.7
R11TO98	T98	617981.7	4753042.5	302.4	4532.3	0	DEN	A	104.8	0	0	0	84.1	7.5	-0.3	0	0	0	0	0	0	13.6
Mohawk05(V82-1.65 MW-Vestas-103.2 dBA&Hu	MH05	623047.0	4746843.0	260.0	3497.4	0	DEN	A	102.1	0	0	0	81.9	14.5	-1.0	0	0	0	0	0	0	6.7
Mohawk02(V82-1.65 MW-Vestas-103.2 dBA&Hu	MH02	622632.0	4746480.0	260.4	3603.5	0	DEN	A	102.1	0	0	0	82.1	14.7	-1.0	0	0	0	0	0	0	6.2
Mohawk04(V82-1.65 MW-Vestas-103.2 dBA&Hu	MH04	623297.0	4746604.0	260.0	3836.6	0	DEN	A	102.1	0	0	0	82.7	15.3	-1.0	0	0	0	0	0	0	5.1
R11TO65	T65	622983.8	4754678.9	299.0	5312.9	0	DEN	A	104.8	0	0	0	85.5	8.4	-0.4	0	0	0	0	0	0	11.3
R11TO49	T49	626835.9	4748915.1	299.0	5826.4	0	DEN	A	104.8	0	0	0	86.3	9.0	-0.5	0	0	0	0	0	0	10.0
R11TO19	T19	620379.6	4755516.1	299.0	5832.8	0	DEN	A	104.8	0	0	0	86.3	9.0	-0.5	0	0	0	0	0	0	10.0
R11TO82	T82	618390.0	4754915.0	299.0	5841.0	0	DEN	A	104.8	0	0	0	86.3	9.0	-0.5	0	0	0	0	0	0	10.0
Mohawk06(V82-1.65 MW-Vestas-103.2 dBA&Hu	MH06	622661.0	4745529.0	263.9	4489.4	0	DEN	A	102.1	0	0	0	84.0	16.8	-1.1	0	0	0	0	0	0	2.3
Transformer2 (100/133/166 ONAN/ONAF/ONAF MVA)	ST2	622836.6	4754678.6	178.7	5259.9	0	DEN	A	103.2	0	0	0	85.4	9.8	-0.3	0	0	4.1	0	0	0	4.1
SWT-2.221-101 - Grand Renewable Energy Project	GREPT58	614974.0	4747470.0	283.2	6498.1	0	DEN	A	105.0	0	0	0	87.3	10.8	-0.4	0	0	0	0	0	0	7.4
R11TO13	T13	621410.0	4756122.0	299.0	6407.1	0	DEN	A	104.8	0	0	0	87.1	9.6	-0.5	0	0	0	0	0	0	8.6
SWT-2.221-101 - Grand Renewable Energy Project	GREPT60	614680.0	4748176.0	282.6	6573.3	0	DEN	A	105.0	0	0	0	87.4	10.9	-0.4	0	0	0	0	0	0	7.2
SWT-2.221-101 - Grand Renewable Energy Project	GREPT61	614750.0	4747811.0	284.5	6601.8	0	DEN	A	105.0	0	0	0	87.4	10.9	-0.4	0	0	0	0	0	0	7.2
R11TO23	T23	627539.7	4748974.3	299.0	6516.8	0	DEN	A	104.8	0	0	0	87.3	9.7	-0.5	0	0	0	0	0	0	8.4
SWT-2.221-101 - Grand Renewable Energy Project	GREPT62	614705.0	4747338.0	281.3	6796.2	0	DEN	A	105.0	0	0	0	87.6	11.1	-0.4	0	0	0	0	0	0	6.7
R11TO12	T12	621127.0	4756402.0	299.2	6678.2	0	DEN	A	104.8	0	0	0	87.5	9.9	-0.6	0	0	0	0	0	0	8.0
Mohawk01(V82-1.65 MW-Vestas-103.2 dBA&Hu	MH01	623355.0	4745400.0	268.2	4893.7	0	DEN	A	102.1	0	0	0	84.8	17.7	-1.1	0	0	0	0	0	0	0.6
R11TO24	T24	627752.2	4750238.9	299.0	6705.6	0	DEN	A	104.8	0	0	0	87.5	9.9	-0.6	0	0	0	0	0	0	7.9
SWT-2.221-101 - Grand Renewable Energy Project	GREPT57	614355.0	4748118.0	284.5	6902.9	0	DEN	A	105.0	0	0	0	87.8	11.2	-0.5	0	0	0	0	0	0	6.5
Mohawk03(V82-1.65 MW-Vestas-103.2 dBA&Hu	MH03	623974.0	4745737.0	265.5	4935.7	0	DEN	A	102.1	0	0	0	84.9	17.8	-1.1	0	0	0	0	0	0	0.4
R11TO91	T91	620503.9	4756520.8	299.1	6820.0	0	DEN	A	104.8	0	0	0	87.7	10.0	-0.6	0	0	0	0	0	0	7.7
SWT-2.221-101 - Grand Renewable Energy Project	GREPT59	614326.0	4747732.0	284.5	7030.6	0	DEN	A	105.0	0	0	0	87.9	11.3	-0.5	0	0	0	0	0	0	6.2
R11TO11	T11	620836.0	4756609.3	299.9	6889.1	0	DEN	A	104.8	0	0	0	87.8	10.1	-0.6	0	0	0	0	0	0	7.5



## Receiver

Name: H1BIRD3890  
 ID: O\_1153  
 X: 621067.4  
 Y: 4749725.2  
 Z: 180.6

Name	ID	X (m)	Y (m)	Z (m)	Dist (m)	Refl.	DEN	Freq. (Hz)	Lw dB(A)	I/a dB	K0 (dB)	Dc (dB)	Adiv (dB)	Aatm (dB)	Agr (dB)	Afol (dB)	Ahous (dB)	Abar (dB)	Cmet (dB)	RL (dB)	Lr dB(A)
R11TO41	T41	620998.0	4756851.0	300.4	7127.2	0	DEN	A	104.8	0	0	0	88.1	10.3	-0.6	0	0	0	0	0	7.0
R11TO72	T72	620828.0	4757122.0	301.3	7401.7	0	DEN	A	104.8	0	0	0	88.4	10.6	-0.6	0	0	0	0	0	6.4
R11TO37	T37	623038.4	4758881.0	299.0	9366.4	0	DEN	A	104.8	0	0	0	90.4	12.4	-0.8	0	0	0	0	0	2.8
R11TO10	T10	623259.5	4758989.9	299.0	9521.3	0	DEN	A	104.8	0	0	0	90.6	12.5	-0.8	0	0	0	0	0	2.6
WF01(Wainfleet Wind Energy Project Vesta Rosa Flora Turbine)	WF01	631359.0	4751252.0	270.1	10404.7	0	DEN	A	105.0	0	0	0	91.3	13.6	-1.7	0	0	0	0	0	1.8
WF02(Wainfleet Wind Energy Project Vesta)	WF02	631758.0	4750750.0	270.9	10740.0	0	DEN	A	105.0	0	0	0	91.6	13.8	-1.8	0	0	0	0	0	1.3
WF03(Wainfleet Wind Energy Project Vesta)	WF03	631921.0	4750541.0	271.3	10884.7	0	DEN	A	105.0	0	0	0	91.7	13.9	-1.8	0	0	0	0	0	1.2
R11TS09	T95	622816.6	4760851.0	304.0	11263.2	0	DEN	A	104.8	0	0	0	92.0	13.8	-1.0	0	0	0	0	0	0.0
WF05(Wainfleet Wind Energy Project Vesta)	WF05	632706.0	4748817.0	272.1	11674.4	0	DEN	A	105.0	0	0	0	92.3	14.4	-1.9	0	0	0	0	0	0.2
WF04(Wainfleet Wind Energy Project Vesta)	WF04	632750.0	4748389.0	273.8	11759.2	0	DEN	A	105.0	0	0	0	92.4	14.4	-2.0	0	0	0	0	0	0.1
R11TO09	T09	616789.8	4762576.1	304.0	13544.8	0	DEN	A	104.8	0	0	0	93.6	15.3	-1.3	0	0	0	0	0	-2.9
R11TO51	T51	617020.3	4762751.8	304.0	13641.4	0	DEN	A	104.8	0	0	0	93.7	15.4	-1.3	0	0	0	0	0	-3.0
Transformer1 (100/133/166 ONAN/ONAF/ONAF MVA)	ST1	621959.7	4761728.0	182.3	12036.0	0	DEN	A	103.2	0	0	0	92.6	17.0	1.0	0	0	3.2	0	0	-10.6
R11TO07	T07	618635.6	4764052.9	304.0	14533.2	0	DEN	A	104.8	0	0	0	94.2	15.9	-1.5	0	0	0	0	0	-3.9
R11TO75	T75	621356.9	4764542.6	304.0	14820.8	0	DEN	A	104.8	0	0	0	94.4	16.1	-1.5	0	0	0	0	0	-4.2
R11TO39	T39	617348.6	4764279.3	304.0	15022.2	0	DEN	A	104.8	0	0	0	94.5	16.2	-1.5	0	0	0	0	0	-4.4
R11TO32	T32	624780.5	4764409.8	304.0	15147.4	0	DEN	A	104.8	0	0	0	94.6	16.3	-1.6	0	0	0	0	0	-4.5
R11TO29	T29	628498.0	4763100.5	303.1	15301.3	0	DEN	A	104.8	0	0	0	94.7	16.4	-1.6	0	0	0	0	0	-4.7
R11TO34	T34	626486.0	4764591.4	304.0	15823.5	0	DEN	A	104.8	0	0	0	95.0	16.6	-1.7	0	0	0	0	0	-5.2
R11TO54	T54	619944.0	4765594.0	304.0	15909.0	0	DEN	A	104.8	0	0	0	95.0	16.7	-1.7	0	0	0	0	0	-5.3
R11TO35	T35	627163.5	4764483.1	304.0	15968.0	0	DEN	A	104.8	0	0	0	95.1	16.7	-1.7	0	0	0	0	0	-5.3
R11TO38	T38	620669.2	4765751.8	304.0	16032.0	0	DEN	A	104.8	0	0	0	95.1	16.8	-1.7	0	0	0	0	0	-5.4
R11TO01	T01	622985.8	4765745.3	306.3	16135.1	0	DEN	A	104.8	0	0	0	95.2	16.8	-1.7	0	0	0	0	0	-5.5
R11TO76	T76	623639.9	4765719.5	304.0	16200.3	0	DEN	A	104.8	0	0	0	95.2	16.8	-1.7	0	0	0	0	0	-5.5
R11TO97	T97	617214.7	4765641.9	306.9	16376.9	0	DEN	A	104.8	0	0	0	95.3	16.9	-1.7	0	0	0	0	0	-5.7
R11TO03	T03	629895.5	4763587.6	304.0	16435.3	0	DEN	A	104.8	0	0	0	95.3	17.0	-1.7	0	0	0	0	0	-5.7
R11TO08	T08	614544.5	4764911.4	304.7	16528.3	0	DEN	A	104.8	0	0	0	95.4	17.0	-1.8	0	0	0	0	0	-5.8
R11TO31	T31	625150.0	4765821.0	309.0	16606.1	0	DEN	A	104.8	0	0	0	95.4	17.1	-1.8	0	0	0	0	0	-5.9
R11TO74	T74	621655.8	4763002.3	303.7	13290.7	0	DEN	A	102.9	0	0	0	93.5	13.8	-1.4	0	0	0	0	0	-3.1
R11TO36	T36	622378.6	4763063.1	299.0	13402.8	0	DEN	A	102.9	0	0	0	93.5	13.9	-1.4	0	0	0	0	0	-3.2
R11TO78	T78	628581.0	4764783.0	304.0	16828.8	0	DEN	A	104.8	0	0	0	95.5	17.2	-1.8	0	0	0	0	0	-6.1
R11TO33	T33	626968.7	4765950.4	309.0	17265.6	0	DEN	A	104.8	0	0	0	95.7	17.4	-1.9	0	0	0	0	0	-6.4
R11TO02	T02	627379.8	4765942.2	309.0	17402.7	0	DEN	A	104.8	0	0	0	95.8	17.4	-1.9	0	0	0	0	0	-6.6
R11TO93	T93	618324.0	4767127.0	309.0	17617.2	0	DEN	A	104.8	0	0	0	95.9	17.5	-1.9	0	0	0	0	0	-6.7
R11TO06	T06	623095.6	4767244.5	310.0	17636.8	0	DEN	A	104.8	0	0	0	95.9	17.6	-1.9	0	0	0	0	0	-6.8
R11TO81a	T81	616342.8	4766967.0	309.0	17877.9	0	DEN	A	104.8	0	0	0	96.0	17.7	-2.0	0	0	0	0	0	-7.0
R11TO52	T52	614214.8	4766530.6	309.7	18149.3	0	DEN	A	104.8	0	0	0	96.2	17.8	-2.0	0	0	0	0	0	-7.2
R11TO55	T55	623610.3	4764393.4	304.0	14887.6	0	DEN	A	102.9	0	0	0	94.5	14.6	-1.6	0	0	0	0	0	-4.6
R11TO66	T66	619127.0	4768529.0	314.0	18904.2	0	DEN	A	104.8	0	0	0	96.5	18.1	-2.1	0	0	0	0	0	-7.7
R11TO27	T27	622534.5	4768708.0	314.0	19039.9	0	DEN	A	104.8	0	0	0	96.6	18.2	-2.1	0	0	0	0	0	-7.9
R11TO04	T04	627524.4	4767739.7	309.0	19137.2	0	DEN	A	104.8	0	0	0	96.6	18.2	-2.2	0	0	0	0	0	-7.9
R11TO94	T94	618752.1	4768764.2	314.0	19179.8	0	DEN	A	104.8	0	0	0	96.7	18.3	-2.2	0	0	0	0	0	-8.0
R11TO57	T57	624435.2	4768696.0	309.0	19267.9	0	DEN	A	104.8	0	0	0	96.7	18.3	-2.2	0	0	0	0	0	-8.0



## **Appendix F Additional Information**

---



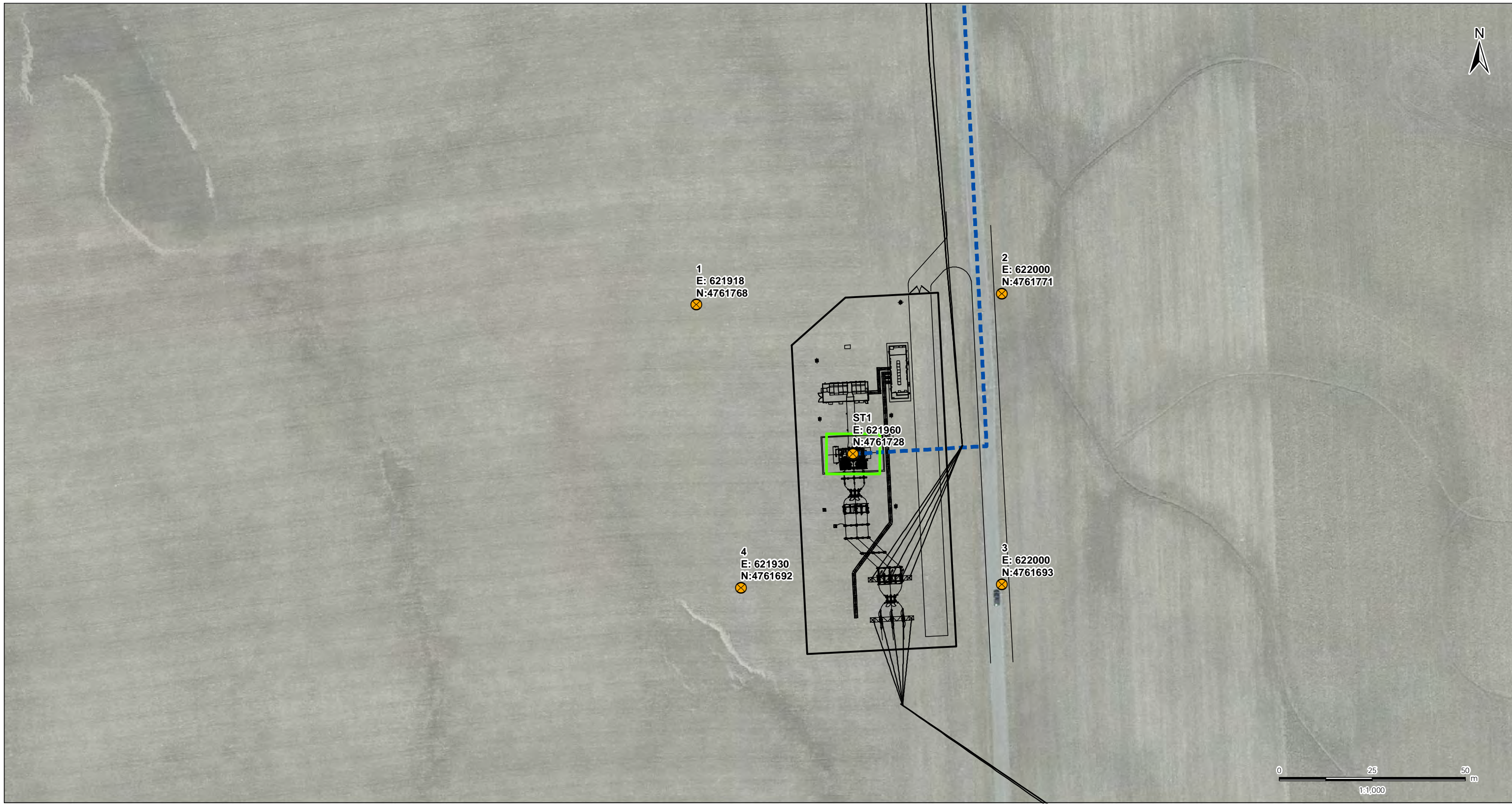





V:\01609\Active\160950269\Planning\drawing\mxd\Modification\_Reports\Acoustic\_Assessment\160950269\_Figure\_F1\_F2\_Substations\_Layout.mxd  
Revised: 2015-09-21 By: bcowper

September 2015  
133560006



- Legend**
-  Noise Emission Locations
  -  Barrier
  -  Potential Access Road
  -  Transformer Substation

- Notes**
1. Coordinate System: NAD 1983 UTM Zone 17N
  2. Base features produced under license with the Ontario Ministry of Natural Resources © Queen's Printer for Ontario, 2013.
  3. Orthoimagery © First Base Solutions, 20xx.

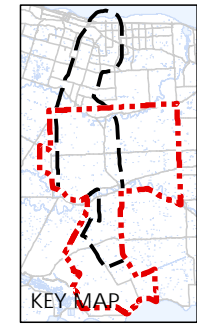

Client/Project  
FWRN LP  
Niagara Region Wind Farm  
Acoustic Assessment Report

---

Figure No.  
F.1

---

Title  
North Transformer Station



V:\01609\Active\160950269\Planning\drawing\mxd\Modification\_Reports\Acoustic\_Assessment\160950269\_Figure\_F1\_F2\_Substations\_Layout.mxd  
 Revised: 2015-09-21 By: bcowper



- Notes**
1. Coordinate System: NAD 1983 UTM Zone 17N
  2. Base features produced under license with the Ontario Ministry of Natural Resources © Queen's Printer for Ontario, 2013.
  3. Orthoimagery © First Base Solutions, 20xx.

- Legend**
- Noise Emission Locations
  - Barrier
  - Proposed Turbine Location - E101 3.0 MW
  - Potential Access Road
  - Temporary Laydown Area
  - Watercourse
  - Transformer Substation
  - Turbine Blade Length

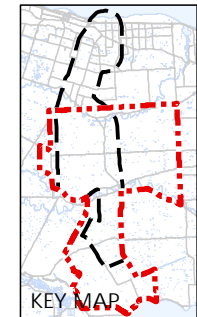

Client/Project  
 FWRN LP  
 Niagara Region Wind Farm  
 Acoustic Assessment Report

---

Figure No.  
 F.2

---

Title  
 South Transformer Station



**MANUFACTURERS SOUND EMISSION  
AND ADJUSTED SOUND EMISSION**



**Table 3.1 Wind Turbine Sound Emission Summary**

**Make: ENERCON**

**Model: E101**

**Electrical Rating: 3MW**

**Hub Height: 124 m or 135 m**

**Data Source: Enercon (Appendix D) - for all wind shear above 0.2**

**Octave Band Sound Power Level (dB ref. 10<sup>-12</sup> Watts)**

		Manufacturer's Emission Level					Adjusted Emission Level				
10m Height Wind Speed (m/s)		6	7	8	9	10	6	7	8	9	10
Frequency (Hz)	63	111.3	112	112.4	112.3	--	112.5	112.5	112.5	112.5	112.5
	125	106.5	107.2	107.6	107.5	--	107.7	107.7	107.7	107.7	107.7
	250	106	106.7	107.1	107	--	107.2	107.2	107.2	107.2	107.2
	500	102.8	103.5	103.9	103.8	--	104	104	104	104	104
	1000	97.1	97.8	98.2	98.1	--	98.3	98.3	98.3	98.3	98.3
	2000	90.4	91.1	91.5	91.4	--	91.6	91.6	91.6	91.6	91.6
	4000	83.7	84.4	84.8	84.7	--	84.9	84.9	84.9	84.9	84.9
	8000	73.2	73.9	74.3	74.2	--	74.4	74.4	74.4	74.4	74.4
Overall (dBA ref. 10 <sup>-12</sup> Watts)		103.6	104.3	104.7	104.6	--	104.8	104.8	104.8	104.8	104.8

**Make: ENERCON**

**Model: E82**

**Electrical Rating: 2.3MW**

**Hub Height: 135 m**

**Data Source: Enercon (Appendix D) - for all wind shear above 0.2**

**Octave Band Sound Power Level (dB ref. 10<sup>-12</sup> Watts)**

		Manufacturer's Emission Level					Adjusted Emission Level				
10m Height Wind Speed (m/s)		6	7	8	9	10	6	7	8	9	10
Frequency (Hz)	63	111.1	111.7	111.8	112.8	113.2	112.8	112.8	112.8	112.8	112.8
	125	106.7	108.9	109.3	110.7	110.7	110.7	110.7	110.7	110.7	110.7
	250	100.6	102.8	103.2	102.9	102.3	102.9	102.9	102.9	102.9	102.9
	500	98.9	100.8	101.4	100.5	99.7	100.5	100.5	100.5	100.5	100.5
	1000	95.9	97.7	98.5	98.7	98.3	98.7	98.7	98.7	98.7	98.7
	2000	87.8	90.2	91	92.6	92.8	92.6	92.6	92.6	92.6	92.6
	4000	74.8	77.5	78.4	80.5	81.5	80.5	80.5	80.5	80.5	80.5
	8000	76.5	75.5	74.5	74.5	76.3	74.5	74.5	74.5	74.5	74.5
Overall (dBA ref. 10 <sup>-12</sup> Watts)		100.6	102.6	103.2	103.3	102.9	103.3	103.3	103.3	103.3	103.3

<sup>1</sup> As per the data, overall sound power data is available from 6 m/s (corresponding to 1414 kW or approximately 38% of the rated power) to 9 m/s (corresponding to 2987 kW or approximately 99.6% of the rated power of 3MW). As per the test, the maximum sound power level occurs at 8.3 m/s wind speed and corresponding spectral data is given in the data sheet. The spectral data for other wind speed were obtained by scaling based on the overall data.

<sup>2</sup> No data was given for the 10 m/s wind speed since the turbine reaches 95% of rated power output at 8.3 m/s wind speed. For this model the attached test report indicates that the maximum sound power level occurs at 8.3 m/s wind speed. The maximum sound power level as provided from manufacturer was used. A wind shear adjusted sound data is provided in Appendix F.

## **MANUFACTURER’S CATALOG DATA**

# E101

3,000 kW



## Calculated power curve

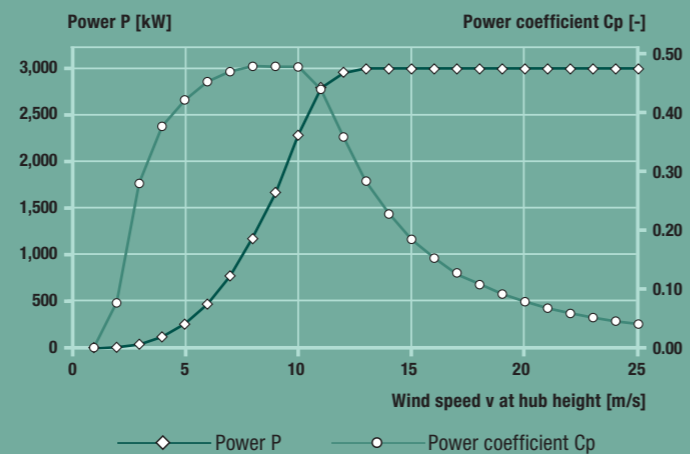

Wind [m/s]	Power P [kW]	Power coefficient Cp [-]
1	0.0	0.000
2	3.0	0.076
3	37.0	0.279
4	118.0	0.376
5	258.0	0.421
6	479.0	0.452
7	790.0	0.469
8	1,200.0	0.478
9	1,710.0	0.478
10	2,340.0	0.477
11	2,867.0	0.439
12	3,034.0	0.358
13	3,050.0	0.283
14	3,050.0	0.227
15	3,050.0	0.184
16	3,050.0	0.152
17	3,050.0	0.127
18	3,050.0	0.107
19	3,050.0	0.091
20	3,050.0	0.078
21	3,050.0	0.067
22	3,050.0	0.058
23	3,050.0	0.051
24	3,050.0	0.045
25	3,050.0	0.040

$\rho = 1.225 \text{ kg/m}^3$

For more information on the ENERCON power curve, please see the last page.

## Technical specifications E-101

Rated power: 3,000 kW  
 Rotor diameter: 101 m  
 Hub height: 99 m / 135 m  
 Wind zone (DIBT): WZ III  
 Wind class (IEC): IEC/NVN IIA

**WEC concept:** Gearless, variable speed  
 Single blade adjustment

### Rotor

Type: Upwind rotor with active pitch control  
 Rotational direction: Clockwise  
 No. of blades: 3  
 Swept area: 8,012 m<sup>2</sup>  
 Blade material: GRP (epoxy resin);  
 Built-in lightning protection  
 Rotational speed: Variable, 4–14.5 rpm  
 Pitch control: ENERCON single blade pitch system;  
 one independent pitch system per rotor blade with allocated emergency supply

### Drive train with generator

Hub: Rigid  
 Main bearing: Double-row tapered/cylindrical roller bearings  
 Generator: ENERCON direct-drive annular generator

**Grid feed:** ENERCON inverter

**Brake systems:** – 3 independent pitch control systems with emergency power supply

– Rotor brake  
 – Rotor lock, latching (15°)

**Yaw system:** Active via yaw gear, load-dependent damping

**Cut-out wind speed:** 28–34 m/s (with ENERCON storm control\*)

**Remote monitoring:** ENERCON SCADA

\*For more information on the ENERCON storm control feature, please see the last page.

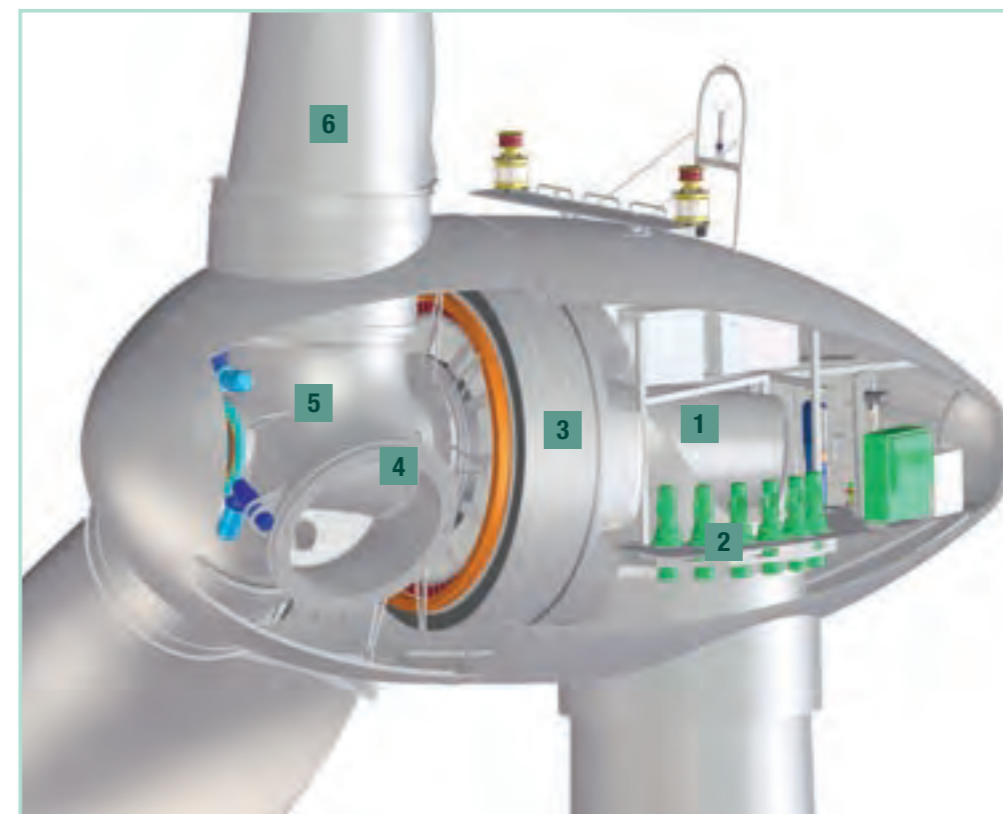

- 1 Main carrier
- 2 Yaw drive
- 3 Annular generator
- 4 Blade adapter
- 5 Rotor hub
- 6 Rotor blade



## WIND ENERGY CONVERTER CHARACTERISTICS E-101

<b>Rotor</b>	
Type	E-101
Rotor diameter	101 m
Swept area	8012 m <sup>2</sup>
Power regulation	Pitch
RPM	4 – 14,5 min <sup>-1</sup>
Cut in wind	2,5 m/s
Cut out wind	28 – 34 m/s
Survival wind speed	59,5 m/s

<b>Gear Box</b>	
Not applicable	No gearbox

<b>Blades</b>	
Manufacturer	ENERCON
Blade length	48,5 m
Material	GRP (Epoxy)
Lightning protection	included

<b>Generator</b>	
Manufacturer	ENERCON
Nominal Power	3000 kW
Type (model)	Synchronous, direct-drive ringgenerator
Protection classification	IP 23
Insulation class	F

<b>Yaw System</b>	
Type	electrical motors
Yaw control	Active (based on wind vane signal)
Yaw rate	0,5°/sec

<b>Controller</b>	
Manufacturer	ENERCON
Type	microprocessor
Grid connection	Via ENERCON inverter
Remote communication	ENERCON Remote Monitoring System
UPS	included

<b>Braking System</b>	
Aerodynamic brake	<ul style="list-style-type: none"> <li>- three independent blade pitch systems with emergency supply</li> <li>- rotor brake</li> <li>- rotor lock, locking at 30°</li> </ul>

<b>Tower</b>			
Hub heights	99 m	135 m	
Tower	Prefab concrete	Prefab concrete	
Design Wind Class	<b>IIA</b>	<b>IIA</b>	

Sources: Design Assessment

© by ENERCON GmbH. All rights reserved.			
Created/Date:	M. Lüninghöner	Checked:	AH/09/2009
Dpt.:	SL_HB	Approved:	SL_HB_WEC Characteristics_E-101_Rev001_eng-eng.doc
Revision:	001/31.03.2010	Reference :	

## Prevention

All mechanical and electrical components of the wind energy converter in which overheating or short circuits could potentially ignite a fire are permanently monitored by sensors – primarily to ensure their proper functioning – while the WEC is running. If the WEC control system detects irregularities, the wind energy converter stops or continues with limited power. This function is the most effective component of the fire safety system.

## Components

Special fire safety components of the E-70 E4 include:

- One Hekatron ORS 142 smoke detector (see appendix for data sheet) on the rotor head side of the stator support ring
- One Hekatron ORS 142 smoke detector on the machine house side of the stator support ring
- One Hekatron ORS 142 smoke detector on the bottom side of the main carrier (i.e., at the tower top)
- One hand-held CO<sub>2</sub> fire extinguisher in the nacelle
- If required by national regulations, one hand-held CO<sub>2</sub> fire extinguisher in the tower base (ENERCON personnel carry an additional fire extinguisher in their Service vehicles)
- Fire retardant or hardly inflammable or incombustible materials for specific components.



No smoke detectors are installed inside the tower and in the tower base. Since the WEC cooling system transports air from the tower base to the area above the tower top at high speed, the smoke detectors in the nacelle are able to detect a fire in the tower or the tower base.

## Safe stopping of the wind energy converter in hazardous situations

The emergency pitch unit of each rotor blade consists of blade relay box, capacitor box, and pitch motor. If a safety-relevant sensor reports a fault or a safety switch is triggered, the wind energy converter stops immediately. The pitch control boxes disconnect the pitch motors from the control system and switch the contactors in the blade relay boxes to power supply by the capacitor boxes. The rotor blades automatically move into feathered position independently of each other until switched off by limit switches on the blade bearings. In case of an emergency stop of the rotor (in the event of a fire) an additional electromechanical brake is used. Decelerating the rotor from its rated speed to a standstill takes 10 to 15 seconds.



### Fire during WEC operation

There are no persons present in the wind energy converter while it is running. If a fire is detected the rotor of the WEC stops as quickly as possible (emergency stop). The smoke detectors and/or temperature sensors generate signals that are immediately forwarded by the SCADA remote monitoring system to ENERCON Service, who in turn will immediately alert the local fire service and the utility operating the grid. They decide on site which measures are required. The ENERCON Service Center is staffed 24/7 and can thus be contacted at any time

### Fire while persons are present

In this scenario, follow the instructions and rules of conduct below.

- Stop the wind energy converter and turn off the main switch, if still possible. Otherwise, push the EMERGENCY STOP button.
- Call the fire service.
- Rescue any injured persons from the danger zone and ensure first aid is provided.
- Use carbon dioxide fire extinguishers to fight the fire; follow the operating instructions of the fire extinguishers. Only try to fight the fire if you can do so without putting your own safety at risk and if the escape route is clear.
- If the fire cannot be extinguished immediately, do not continue fire fighting efforts. Evacuate the wind energy converter and any ancillary buildings, and leave the WEC. Cordon off a wide area around the WEC.
- If it is no longer possible to descend safely in the tower, climb up into the nacelle and use rescue equipment (abseiling device) to leave the nacelle through the winch hatch.
- Notify the technical manager of the relevant utility company.
- Clear access roads for emergency services.
- Notify ENERCON Service.



If the *Maintenance* status has been activated during service work on the wind energy converter, any signals generated by smoke detectors and other sensors are **not** transmitted to ENERCON Service.

### Maintenance

In the event of a SCADA system fault a corresponding message is sent to the ENERCON Service Center that will then initiate troubleshooting measures at once. The smoke detectors and the SCADA system are inspected in the setting of the annual electrical maintenance. Inspection and maintenance of fire extinguishers is performed in accordance with national regulations.

## Optischer Rauchschalter ORS 142

## Détecteur de fumée optique ORS 142

## ORS 142 optical smoke switch

- optische Rauchererkennung
- Verschmutzungsanzeige
- Alarmschwellennachführung
- kommunikationsfähig
- Meßkammerüberwachung
- potentialfreier Öffner

- détection de fumée optique
- indicateur de colmatage
- correction du seuil d'alarme
- communication
- surveillance par chambre de mesure
- contact d'ouverture exempt de potentiel

- Optical smoke detection
- Contamination warning
- Auto contamination compensation
- Communications capability
- Sensing chamber monitoring
- NC volt-free contact

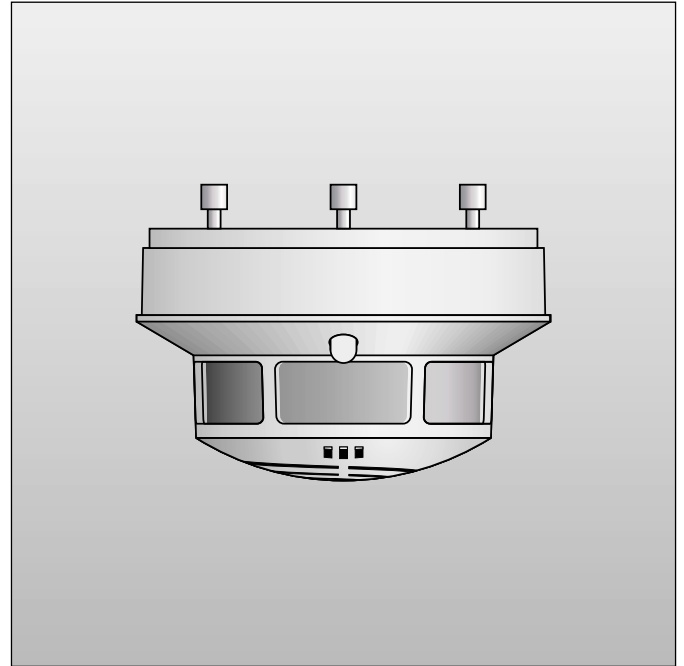

Der optische Rauchschalter ORS 142 erkennt frühzeitig sowohl Schwelbrände als auch offene Brände mit Rauchentwicklung. Ein zusätzlicher Temperaturfühler spricht bei einer Umgebungstemperatur von 70 °C an. Er wird vorzugsweise in Feststellanlagen und maschinellen Rauchabzugsanlagen eingesetzt. Der ORS 142 löst den bisherigen Rauchschalter ORS 132 ab.

Le détecteur de fumée optique ORS 142 décèle rapidement aussi bien les feux couvants que les feux déclarés avec émission de fumée.

Un capteur thermique supplémentaire se déclenche automatiquement à partir d'une température ambiante de 70°C.

Ce dispositif s'utilise de préférence pour les contrôles automatiques des portes et systèmes de désenfumage mécaniques

The ORS 142 optical smoke switch reacts promptly to smouldering fires as well as to flaming fires that develop smoke. An additional temperature sensor is triggered at an ambient temperature of 70 °C.

Its principal application is for door holder/closer systems and powered smoke ventilation systems.

Der ORS 142 arbeitet nach dem Streulichtprinzip. Lichtsender und -empfänger sind in der Meßkammer so angeordnet, daß das Licht des Senders den Empfänger nicht direkt trifft. Erst das an Schwebeteilchen gestreute Licht gelangt zum Empfänger.

Die Auswerteelektronik des ORS 142 überwacht den Rauchmeßteil des Melders zusätzlich auf leichte Verschmutzung, starke Verschmutzung und Störung (Meßkammerausfall).

Die jeweiligen Betriebszustände zeigt der ORS 142 optisch an.

Eine Langzeit-Alarmschwellennachführung sorgt für einen gleichbleibenden Abstand zwischen Grundsignal und Alarmschwelle, bis der Grenzwert für starke Verschmutzung erreicht ist.

Ein Relaiskontakt öffnet bei Alarm sowie bei Spannungsausfall.

### Kommunikation

Der ORS 142 meldet seinen Funktionszustand über Stift 3 an eine RZA 142 (Rauchschalter-Zustandsanzeige). Hier werden ebenfalls die Zustände mit farbigen LEDs optisch angezeigt.

Wird der ORS 142 an ein RSI (Rauchschalter-Interface) angeschlossen, können die Melderzustände mit einem PC abgefragt werden. Mit einem Modem können RSI und PC über eine Postleitung kommunizieren.

L'ORS 142 fonctionne sur le principe de la lumière diffuse. L'émetteur et le récepteur de lumière sont positionnés dans la chambre de mesure de manière que la lumière provenant de l'émetteur ne parvienne pas directement au récepteur, mais seulement sous forme de lumière diffusée sur les particules en suspension.

L'unité d'évaluation électronique de l'ORS 142 surveille le dispositif de mesure de fumée du détecteur afin de déceler l'encrassement, faible ou important, ainsi que les pannes (défaillances de la chambre de mesure). Les états de fonctionnement de l'ORS 142 sont signalés de manière optique. Le dispositif de correction du seuil d'alarme assure un écart constant entre le signal de base et le seuil d'alarme, et ceci jusqu'à ce que la valeur limite d'encrassement important soit atteinte.

Un contact de relais s'ouvre en cas d'alarme ou d'absence de courant.

### Communication

L'ORS 142 signale son état de fonctionnement au niveau de l'ergot 3 de l'indicateur de fonctionnement RZA 142. Des DEL de couleur signalent également les états de fonctionnement de manière optique. Lorsque l'ORS 142 est branché sur une interface de détecteur de fumée, il est possible de vérifier l'état de fonctionnement du détecteur à partir d'un PC. À l'aide d'un modem, l'interface et le PC peuvent communiquer par une ligne téléphonique.

The ORS 142 operates on the light scatter principle. Inside the sensing chamber a light source and a light sensor are arranged so that the light normally does not fall on the sensor. It is only when airborne particles enter the chamber that light is scattered onto the sensor.

The ORS 142 electronic circuitry also monitors the smoke detection system for slight contamination (dust and dirt build-up), heavy contamination and faults (sensing chamber failure). LEDs provide an optical indication of the operating status of the ORS 142. A long-term compensation function automatically maintains a constant difference between the quiescent signal and the alarm threshold, until a set limit indicating heavy contamination is reached.

A relay contact opens in the alarm condition or on power failure.

### Communications

The ORS 142 signals its functional status via pin 3 to an RZA 142 smoke switch status indicator, whose coloured LEDs give an additional remote optical indication of the instrument's condition.

If the ORS 142 is linked to an RSI smoke switch interface, detector status can be scanned from a PC. The RSI and the PC can also communicate over a telecommunications line.

### DIBt-Zulassungen für:

Feststellanlagen	Z-6.5-1571 Z-6.5-1725
maschinelle Rauchabzugsanlagen	Z-78.5-15

### Homologations DIBt pour :

Équipements coupe-feu	Z-6.5-1571 Z-6.5-1725
Systèmes de désenfumage mécaniques	Z-78.5-15

### DIBt approvals for:

Hold-open systems	Z-6.5-1571 Z-6.5-1725
Powered smoke ventilation systems	Z-78.5-15

## Technische Daten/Caractéristiques techniques/Technical data

nach/selon/to EN 54, Teil 7	Rauch	Fumée	Smoke
70 °C	Temperatur	Température	Temperature
18 bis/à/to 28 VDC	Betriebsspannung	Tension de service	Operating voltage
	Stromaufnahme bei 28 V <sub>DC</sub>	Consommation pour 28 V <sub>DC</sub>	Current draw at 28 V DC
max. 21 mA	in Ruhe	au repos	quiescent
max. 10 mA	bei Alarm	en cas d'alarme	in alarm
max. 25 mA	bei Störung	en cas de défaillance	in fault
Öffner/contact d'ouverture/NC	Relaiskontakte	Contacts de relais	Relay contact
max. 30 VDC	Schaltspannung	Tension d'enclenchement	switched voltage
max. 1 A	Schaltstrom	Courant d'enclenchement	switched current
max. 30 W	Schaltleistung	Puissance de rupture	switched power
IP 42	Schutzart	Indice de protection	Ingress protection
-20 bis/à/to +80 °C	Betriebsumgebungstemperatur	Température ambiante d'exploitation	Ambient operating temperature
120 g	Gewicht	Poids	Weight

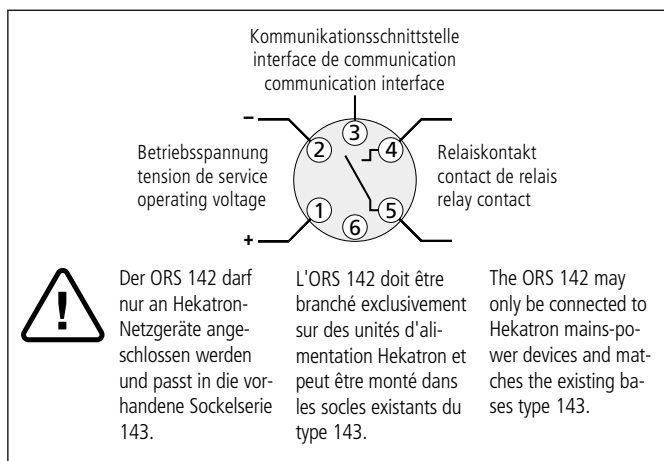
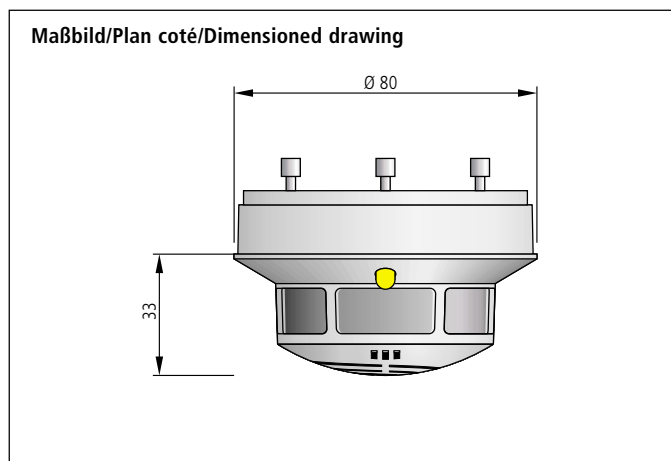

### Relais/Relais/Relay

### Einzelanzeige/Affichage individuel/LED

Betrieb en service in operation		grün/vert/green	—
leicht verschmutzt légèrement encrassé slight contamination		grün/vert/green	
stark verschmutzt encrassé heavy contamination		grün/vert/green	
Störung défaillance fault		gelb/jaune/yellow	—
Alarm alarme alarm		rot/rouge/red	—
spannungslos hors tension power off		dunkel/sombre/dark	—

### Bestelldaten/Références/Ordering data

5 000 552	ORS 142	Rauchschalter, weiß nach RAL 9010	Détecteur de fumée, blanc RAL 9010	Smoke switch, white (DIN shade RAL 9010)
		andere Farben auf Anfrage	autres couleurs sur demande	other colours on request

Technische Änderungen sowie Liefermöglichkeiten vorbehalten.

Sous réserve de modifications techniques ainsi que de possibilités de livraison.

Specifications subject to change without notice. Delivery subject to availability.

www.hekatron.de  
info@hekatron.de

**HEKATRON Vertriebs GmbH**  
Brühlmatten 9  
**D-79295 Sulzburg**  
Telefon (07634) 500-264  
Telefax (07634) 500-323

**HEKATRON**  
Sicherheitssysteme

Ein Unternehmen der  
**Schweizer Securitas Gruppe**

Une entreprise du  
**Groupe suisse Securitas**

A member of the  
**Swiss Securitas Group**

## WIND ENERGY CONVERTER CHARACTERISTICS E-101

<b>Rotor</b>	
Type	E-101
Rotor diameter	101 m
Swept area	8012 m <sup>2</sup>
Power regulation	Pitch
RPM	4 – 14,5 min <sup>-1</sup>
Cut in wind	2,5 m/s
Cut out wind	28 – 34 m/s
Survival wind speed	59,5 m/s

<b>Gear Box</b>	
Not applicable	No gearbox

<b>Blades</b>	
Manufacturer	ENERCON
Blade length	48,5 m
Material	GRP (Epoxy)
Lightning protection	included

<b>Generator</b>	
Manufacturer	ENERCON
Nominal Power	3000 kW
Type (model)	Synchronous, direct-drive ringgenerator
Protection classification	IP 23
Insulation class	F

<b>Yaw System</b>	
Type	electrical motors
Yaw control	Active (based on wind vane signal)
Yaw rate	0,5°/sec

<b>Controller</b>	
Manufacturer	ENERCON
Type	microprocessor
Grid connection	Via ENERCON inverter
Remote communication	ENERCON Remote Monitoring System
UPS	included

<b>Braking System</b>	
Aerodynamic brake	<ul style="list-style-type: none"> <li>- three independent blade pitch systems with emergency supply</li> <li>- rotor brake</li> <li>- rotor lock, locking at 30°</li> </ul>

<b>Tower</b>			
Hub heights	99 m	135 m	
Tower	Prefab concrete	Prefab concrete	
Design Wind Class	<b>IIA</b>	<b>IIA</b>	

Sources: Design Assessment

© by ENERCON GmbH. All rights reserved.			
Created/Date:	M. Lüninghoner	Checked:	AH/09/2009
Dpt.:	SL_HB	Approved:	SL_HB_WEC Characteristics_E-101_Rev001_eng-
Revision:	001/31.03.2010	Reference :	eng.doc

# FUNDAMENT-DATENBLATT FOUNDATION DATA SHEET

## E-101/BF/133/27/01

WZ III (DIBt- Richtlinie Fassung 2004, Anhang B)  
WZ 4; GK I (DIN 1055-4: 2005-03)  
WTC II A (IEC 61400-1, 3rd edition, 2005-08)  
WEA-Klasse II A (DIN EN 61400-1, 2006-07)

Bauteil: **Fundament– Flachgründung ohne Auftriebswirkung**  
Component: **Foundation – Flat Foundation without Buoyancy**

8107894074-7 E I

**Reviewed**  
Essen, 20. April 2011  
*S. Möller*  
S. Möller Expert of  
TÜV NORD SysTec GmbH & Co. KG

**TÜV NORD**  
20. APR. 2011

This document has been forwarded upon request or with regard to a specific order. The recipient has not been registered. The recipient will not be automatically notified about any amendments.

Any copying and disclosure to third parties require the permission of ENERCON GmbH.

<b>Document information:</b>		© Copyright ENERCON GmbH. All rights reserved.	
Author/ date:	MFE / 2011-02-09	Translator / date:	-
Department:	WRD-K	Revisor / date:	-
Approved / date:	TE / 2011-02-09	Reference:	WRD-K-04-FDB-FEB-E-101_BF_133_27_01-Rev_1-EN
Revision / date:	MFE 1 / 2011-03-14		

## 1.0 General information

Design-specific structural analysis:

 Structural calculation by ENERCON GmbH,  
 E-101/BF/133/27/01  
 Flat foundation without buoyancy –  $\varnothing$  20.90 m  
 Revision 1 – 14.03.2011

## 2.0 Foundation dimensions

Outer diameter	$d_a$	20.90 m
Inner diameter	$d_i$	11.20 m
Base diameter – outside	$d_{so,a}$	13.50 m
Base diameter – inside	$d_{so,i}$	8.50 m
Foundation height	$h_{ges}$	3.10 m
Base height	$h_{so}$	0.40 m
Spur incline height	$h_n$	0.60 m
Spur height	$h_{sp}$	2.10 m
Difference between foundation top edge and ground level	$h_{gok}$	0.20 m
Concrete quality and volume	C 30/37	677 m <sup>3</sup>
Reinforcement steel and weight	B 500B	68.6 t

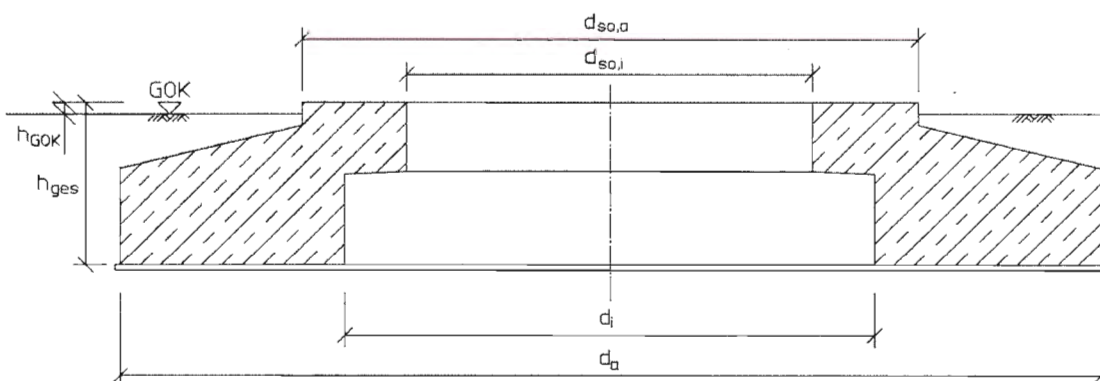

**TUV NORD**  
 20. APR. 2011

**Document information:**

 Author / date: MFE / 2011-02-09  
 Department: WRD-K  
 Approved / date: TE / 2011-02-09  
 Revision / date: MFE 1 / 2011-03-14

© Copyright ENERCON GmbH. All rights reserved.

 Translator / date:  
 Revisor / date:  
 Reference:

WRD-K-04-FDB-FEB-E-101\_BF\_133\_27\_01-Rev\_1-EN



### 3.0 Minimum rocking spring stiffness

Observe the following minimum values with regard to elastic clamping between foundation and subsoil:

<b>Total system</b> (tower and foundation)	<b><math>k_{\varphi,stat}</math></b> <b>15000 [MNm/rad]</b>
	<b><math>k_{\varphi,dyn}</math></b> <b>150000 [MNm/rad]</b>

The resulting required dynamic stiffness moduli ( $E_{oed,dyn}$ ) depend on the foundation dimensions and Poisson's ratio.

Equivalent radius of a circle with the same stiffness:

$$r = 10.23 \text{ m}$$

The following applies to circular foundations:

$$k_{\varphi} = \frac{8 \cdot G \cdot r^3}{3 \cdot (1 - \nu)}$$

This means that

$$E_{oed,dyn} = k_{\varphi} \cdot \frac{3}{4} \cdot \frac{1}{r^3} \cdot \frac{(1 + \nu) \cdot (1 - \nu)^2}{1 - \nu - 2 \cdot \nu^2} \quad \text{where}$$

$G$  = shear modulus  
 $r$  = radius  
 $\nu$  = Poisson's ratio

### 4.0 Allowed inclination

Maximum allowed inclination due to subsoil settlement within 20 years, related to the outer diameter.

$$\Delta s \leq 40 \text{ mm}$$

### 5.0 Soil bearing pressure

The in-situ subsoil must be able to bear a minimum pressure of  $\sigma_{k,vorh} = 401 \text{ kN/m}^2$ .



**TUV NORD**  
 20. APR. 2011

<b>Document information:</b>		© Copyright ENERCON GmbH. All rights reserved.	
Author / date:	MFE / 2011-02-09	Translator / date:	-
Department:	WRD-K	Revisor / date:	-
Approved / date:	TE / 2011-02-09	Reference:	WRD-K-04-FDB-FEB-E-101_BF_133_27_01-Rev_1-EN
Revision / date:	MFE 1 / 2011-03-14		

## 6.0 Loads at the bottom edge of the foundation

The  $F_z$  loads indicated include the dead weight of the foundation  $\gamma = 25 \text{ kN/m}^3$  and soil weight  $\gamma = 18 \text{ kN/m}^3$  when dry.

### 6.1 Characteristic load cases

Load case	( $\gamma_{aero}/\gamma_{mass}$ )	$F_{xy}$ [kN]	$F_z$ [kN]	$M_{xy}$ [kNm]	$M_z$ [kNm]
DLC 1.0	(1.00/1.00)	1100	-36707	103954	-
DLC 3.2	(1.00/1.00)	1470	-36790	153801	-8420
DLC 6.2	(1.00/1.00)	1700	-36590	189565	-8590

Loads do not include partial safety factor ( $\gamma_F = 1.0$ )

### 6.2 Load case design values

Load case	( $\gamma_{aero}/\gamma_{mass}$ )	$F_{xy}$ [kN]	$F_z$ [kN]	$M_{xy}$ [kNm]	$M_z$ [kNm]
DLC 3.2	(1.35/1.35)	2110	-49067	217115	-11600
DLC 3.2	(1.35/1.00)	2110	-36808	217115	-11600

All loads include partial safety factors

## 7.0 Coordinate system

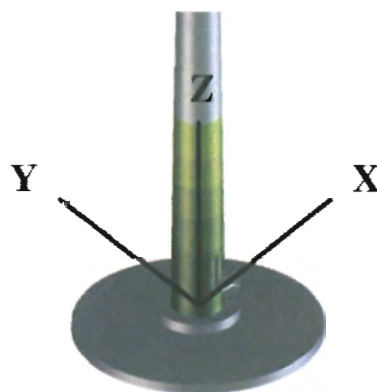

In der folgenden Tabelle sind die Gewichte der Transport- und Aufbaueinheiten der E-101 angegeben. Es ist zu beachten, dass es sich dabei um ca.-Angaben handelt. Bei den Einzelgewichten sind jeweils die notwendigen Transport- und Aufbauvorrichtungen berücksichtigt, das angegebene Gondelgesamtwicht entspricht der Turmkopfmasse nach Fertigstellung der Anlage.

In the following table the weights of the transport and installation component-assemblies of the E-101 are given. It is to be noted that the values are approximated. The weights include the necessary transport and installation devices, the given value for overall nacelle weight corresponds to the tower head mass after completion of the turbine.

Transport	Transport		
Rotorblatt mit HKS	Rotor blade with fin	ca. 21,0	t
3x HKS	3x Fin	ca. 2,4	t
Rotornabe	Rotor hub	ca. 50,0	t
Generator	Generator	ca. 83,0	t
Gondel (Maschinenträger etc.)	Nacelle (main carrier etc.)	ca. 59,0	t
Aufbau	Installation		
Rotornabe (incl. Rotorblätter)	Rotor hub (incl. rotor blades)	ca. 115,0	t
Generator	Generator	ca. 84,0	t
Generator-Stator	Generator stator	ca. 52,0	t
Generator-Rotor	Generator rotor	ca. 35,0	t
Gondel (Maschinenträger etc.)	Nacelle (main carrier etc.)	ca. 59,0	t
Gondelgesamtwicht	Overall nacelle weight	ca.255,0	t

© Copyright ENERCON GmbH. Alle Rechte vorbehalten.

# Sound Power Level of the ENERCON E-101 3.0 MW

**Publisher:**

ENERCON Canada Inc.  
1000, rue de La Gauchetière ouest Bureau 2310  
Montréal, QC, H3B 4W5  
+1 514 ENERCON (+1 514 363 7266)

**Copyright:**

© ENERCON Canada Inc. Any reproduction, distribution and utilisation of this document as well as the communication of its contents to third parties without express authorisation is prohibited. Violators will be held liable for monetary damages. All rights reserved in the event of the grant of a patent, utility model or design.

**Content subject to change:**

ENERCON Canada Inc. reserves the right to change, improve and expand this document and the subject matter described herein at any time without prior notice.

Author/date:	H.Shahriar /15.06.12	Translator/date:	N.Nnnn / DD.MM.YY
Department:	Sales	Revisor/date:	H.Shahriar / 28.05.13
Approved/date:	E. DeGroot/29.05.13	Reference:	Annex 12 Sound Power Level E-101d
Released/date:	H.Shahriar /29.05.13		

The following represents the maximum sound power level of the E-101 3.0 MW for the entire operational range of wind speeds in accordance with the measurement technique IEC 61 400 – 11:2002 and A1:2006.

### Sound Power Level for the E-101 with 3.0 MW rated power

Hub Height	124m	135m
95% rated power	104.8 dB(A)	104.8 dB(A)

1. A tonal audibility of  $\Delta L_{a,k} \leq 2 \text{ dB}$  can be expected over the whole operational range and is valid in the near vicinity of the turbine according to IEC 61 400 -11 ed. 2.
2. Sound power level values provided in the table are valid for the **Operational Mode I**. The respective power curve is the calculated power curve E-101 dated October 2009 (Rev 2.0).
3. Due to typical measurement uncertainties, if the sound power level is measured according to the accepted method, the measured values can differ from the values shown in this document in the range of +/- 1dB.

Accepted measurement method:

IEC 61400-11 ed.2 (“Wind turbine generator systems – Part 11: Acoustic noise measurement techniques; Second edition, 2002 – 12”).

If the difference between tonal noise and background noise during a measurement is less than 6 dB, a higher uncertainty must be considered.

4. The sound power level of a wind turbine depends on several factors such as, but not limited to, regular maintenance and day-to-day operation in compliance with the manufacturer’s operating instructions. Therefore, this data sheet cannot, and is not intended to, constitute an express or implied warranty towards the customer that the E-101 WEC will meet the exact sound power level as shown in this document at any project specific site.

Author/date:	H.Shahriar /15.06.12	Translator/date:	N.Nnnn / DD.MM.YY
Department:	Sales	Revisor/date:	H.Shahriar / 28.05.13
Approved/date:	E. DeGroot/29.05.13	Reference:	Annex 12 Sound Power Level E-101d
Released/date:	H.Shahriar /29.05.13		

## Summary of Test Report (Measured hub height of 99 m) /1/

Master Data Sheet "Geräusche" (Noise), in accordance with  
 "Technische Richtlinien für Windenergieanlagen, Teil 1: Bestimmung der Schallemissionswerte"  
 (Technical Guidelines for Wind Turbine Generators, Part 1: Determination of sound emission values)

Rev. 18 of February 1, 2008 (Editor: Fördergesellschaft Windenergie e.V. Stresemannplatz 4, D-24103 Kiel)

Extract of Test Report 213122-02.01 IEC  
 on noise emission of wind turbine generator of type E-101

General Data		Technical Data (manufacturer's specifications)	
Manufacturer of WTG:	Enercon GmbH	Rated power (generator):	3,050 (3,250) kW
Serial number:	1010002	Diameter of rotor:	101 m
Location of WTG (approx.):	49733 Haren	Hub height above ground:	99 m
Geographic co-ordinates:	GK longitude: 25.76.214 GK latitude: 58.59.856	Type of tower:	conical tubular concrete
		Power control:	Pitch
Complementary rotor data (manufacturer's specifications)		Complementary data of gear unit and generator (manufacturer's specifications)	
Manufacturer of rotor blade:	Enercon	Manufacturer of gear unit:	not applicable
Type of rotor blade:	E-101-1	Type of gear unit:	not applicable
Blade setting angle:	variable	Manufacturer of generator:	Enercon
Number of rotor blades:	3	Type of generator:	G-101/30-G2
Rotor speed range:	5 to 14.7 rpm. (mode OM I)	Rated speed of generator:	5 to 14.7 rpm. (mode OM I)

Calculated Performance Chart: Performance characteristic E101 3 MW OM I ; calculated by ENERCON (Rev. 1.0)

	Reference Point		Noise emission parameters	Observations
	standardized wind speed at a height of 10 m	true electrical power		
sound power level $L_{WA,P}$	6 $ms^{-1}$	1,414 kW	103.6 dB(A)	
	7 $ms^{-1}$	2,077 kW	104.3 dB(A)	
	8 $ms^{-1}$	2,751 kW	104.8 dB(A)	
	9 $ms^{-1}$	2,987 kW	104.6 dB(A)	(1)
	10 $ms^{-1}$	3,050 kW	--	(2)
tonal audibility $\Delta L_{a,k}$	6 $ms^{-1}$	1,414 kW	- 1.5 dB	
	7 $ms^{-1}$	2,077 kW	0 dB	
	8 $ms^{-1}$	2,751 kW	0 dB	
	9 $ms^{-1}$	2,987 kW	0 dB	(1)
	10 $ms^{-1}$	3,050 kW	--	(2)
impulse adjustment for immediate vicinity $K_{IN}$	6 $ms^{-1}$	1,414 kW	0 dB	
	7 $ms^{-1}$	2,077 kW	0 dB	
	8 $ms^{-1}$	2,751 kW	0 dB	
	9 $ms^{-1}$	2,987 kW	0 dB	(1)
	10 $ms^{-1}$	3,050 kW	--	(2)

Third-octave band sound power level for $v_s = 6 ms^{-1}$ in dB(A)													
Frequency	50	63	80	100	125	160	200	250	315	400	500	630	
$L_{WA,P}$	78.3	81.8*	83.0**	84.2	89.6	85.7*	89.2	92.7	94.1	94.6	95.1	94.9	
Frequency	800	1,000	1,250	1,600	2,000	2,500	3,150	4,000	5,000	6,300	8,000	10,000	
$L_{WA,P}$	93.5	91.6	90.0	89.0	85.4	84.1	82.3	79.3	74.8	67.8*	64.7**	65.3**	

Octave band sound power level for $v_s = 6 ms^{-1}$ in dB(A)							
Frequency	63	125	250	500	1,000	2,000	8,000
$L_{WA,P}$	85.6*	91.9	97.2	99.6	96.7	91.5	70.3*

Third-octave band sound power level for $v_s = 7 ms^{-1}$ in dB(A)													
Frequency	50	63	80	100	125	160	200	250	315	400	500	630	
$L_{WA,P}$	78.9	83.3	84.0	84.9	88.2	86.4*	89.6	94.7	94.9	95.4	95.8	95.5	
Frequency	800	1,000	1,250	1,600	2,000	2,500	3,150	4,000	5,000	6,300	8,000	10,000	
$L_{WA,P}$	94.0	92.0	90.4	89.3	86.1	84.7	82.9	79.9	74.4*	68.4*	64.6**	62.7**	

Octave band sound power level for $v_s = 7 ms^{-1}$ in dB(A)							
Frequency	63	125	250	500	1,000	2,000	8,000
$L_{WA,P}$	87.3	91.5	98.4	100.3	97.1	91.9	71.5**



Third-octave band sound power level for $v_s = 8 \text{ ms}^{-1}$ in dB(A)												
Frequency	50	63	80	100	125	160	200	250	315	400	500	630
$L_{WA,P}$	82.1	82.8	84.4	88.4	86.8	90.1	94.8	95.0	95.6	96.3	96.2	82.1
Frequency	800	1,000	1,250	1,600	2,000	2,500	3,150	4,000	5,000	6,300	8,000	10,000
$L_{WA,P}$	95.0	93.3	91.5	90.4	86.7	85.4	83.7	80.9	75.9	69.7*	67.1**	65.5**
Octave band sound power level for $v_s = 8 \text{ ms}^{-1}$ in dB(A)												
Frequency	63	125	250	500	1,000	2,000	4,000	8,000				
$L_{WA,P}$	86.3	91.6	98.6	100.8	98.3	92.8	86.0	73.3**				
Third-octave band sound power level for $v_s = 9 \text{ ms}^{-1}$ in dB(A)												
Frequency	50	63	80	100	125	160	200	250	315	400	500	630
$L_{WA,P}$	78.6	81.9	82.4*	83.9	87.8	85.9*	88.6	93.8	94.2	95.1	96.0	96.3
Frequency	800	1,000	1,250	1,600	2,000	2,500	3,150	4,000	5,000	6,300	8,000	10,000
$L_{WA,P}$	95.4	93.8	92.3	91.0	87.4	86.0	84.1	81.1	76.7	71.7	68.4	66.8*
Octave band sound power level for $v_s = 9 \text{ ms}^{-1}$ in dB(A)												
Frequency	63	125	250	500	1,000	2,000	4,000	8,000				
$L_{WA,P}$	86.0	90.8	97.6	100.6	98.8	93.5	86.4	74.2				

This summary of the test report is valid only in combination with the manufacturer's certificate dated 12/03/2013.

**These specifications do not replace the test report mentioned above (particularly for noise immission predictions).**

- Observations:
- (1) Maximum value of standardized wind speed during the WTG-operation measurement  $v_s = 8,9 \text{ m/s}$
  - (2) Due to weather conditions, no data available during WTG operation
  - \* Difference between working and background noise < 6 dB, correction by 1.3 dB
  - \*\* Difference between working and background noise < 3 dB, values shall not be presented

/1/ Wind turbine generator systems – Part 11: Acoustic noise; measurement techniques (IEC 61400-11:2002 and A1:2006); German version DIN EN 61400-11:2007

Measured by: KÖTTER Consulting Engineers  
- Rheine -



Dipl.-Ing. Oliver Bunk      Matthias Humpohl, B.Sc.

Date: 23/04/2013

# E82

## 2,300 kW



### Calculated power curve

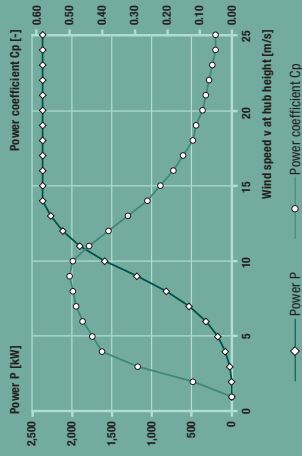

Wind [m/s]	Power P [kW]	Power coefficient Cp [-]
1	0.0	0.00
2	3.0	0.12
3	25.0	0.29
4	82.0	0.40
5	174.0	0.43
6	321.0	0.46
7	532.0	0.48
8	815.0	0.49
9	1,180.0	0.50
10	1,580.0	0.49
11	1,890.0	0.44
12	2,100.0	0.38
13	2,250.0	0.32
14	2,350.0	0.26
15	2,350.0	0.22
16	2,350.0	0.18
17	2,350.0	0.15
18	2,350.0	0.12
19	2,350.0	0.11
20	2,350.0	0.09
21	2,350.0	0.08
22	2,350.0	0.07
23	2,350.0	0.06
24	2,350.0	0.05
25	2,350.0	0.05

$\rho = 1.225 \text{ kg/m}^3$

For more information on the ENERCON power curve, please see the last page.

### Technical specifications E-82 E2

<b>Rated power:</b>	2,300 kW	<b>Drive train with generator</b>	Rigid
<b>Rotor diameter:</b>	82 m	<b>Hub:</b>	Double-row tapered/cylindrical roller bearings
<b>Hub height:</b>	78 m / 85 m / 98 m / 108 m / 138 m	<b>Main bearing:</b>	ENERCON direct-drive annular generator
<b>Wind zone (DIB):</b>	WZ III	<b>Generator:</b>	ENERCON inverter
<b>Wind class (IEC):</b>	IEC/NW1 IIA	<b>Grid feed:</b>	ENERCON pitch control systems
<b>WEC concept:</b>	Gearless, variable speed Single blade adjustment	<b>Brake systems:</b>	with emergency power supply - Rotor brake - Rotor lock
<b>Rotor</b>		<b>Yaw system:</b>	Active via yaw gear, load-dependent damping
<b>Type:</b>	Upwind rotor with active pitch control	<b>Cut-out wind speed:</b>	28–34 m/s (with ENERCON storm control*)
<b>Rotational direction:</b>	Clockwise	<b>Remote monitoring:</b>	ENERCON SCADA
<b>No. of blades:</b>	3		
<b>Swept area:</b>	5,281 m <sup>2</sup>		
<b>Blade material:</b>	GRP (epoxy resin); Built-in lightning protection		
<b>Rotational speed:</b>	Variable, 6–18 rpm		
<b>Pitch control:</b>	ENERCON single blade pitch system; one independent pitch system per rotor blade with allocated emergency supply		

\*For more information on the ENERCON storm control feature, please see the last page.

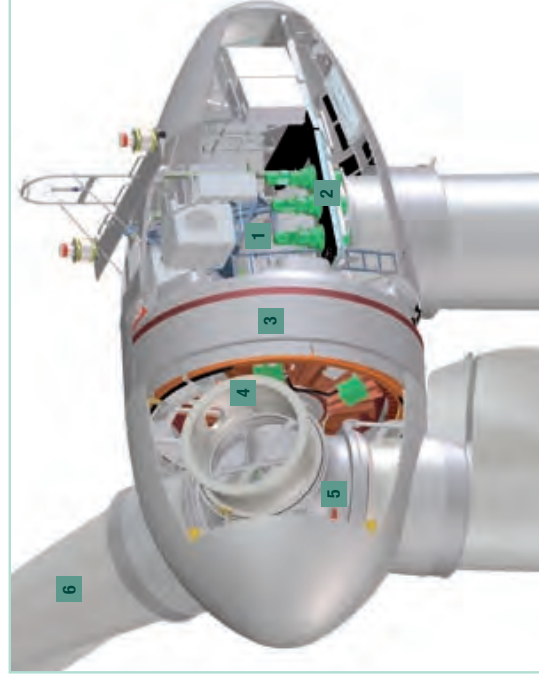

## WIND ENERGY CONVERTER CHARACTERISTICS

### E-82 E2 2.3MW

<b>Rotor</b>	
Type	E82 E2
Rotor diameter	82 m
Swept area	5281 m <sup>2</sup>
Power regulation	Pitch
RPM	6 – 18 min <sup>-1</sup>
Cut in wind	2,5 m/s
Cut out wind	28 – 34 m/s
Survival wind speed	59,5 m/s

<b>Gear Box</b>	
Not applicable	No gearbox

<b>Blades</b>	
Manufacturer	ENERCON
Blade length	38,8 m
Material	GRP (Epoxy)
Lightning protection	included

<b>Generator</b>	
Manufacturer	ENERCON
Nominal Power	2300 kW
Type (model)	Synchronous, direct-drive ringgenerator
Protection classification	IP 23
Insulation class	F

<b>Yaw System</b>	
Type	6 electrical motors
Yaw control	Active (based on wind vane signal)
Yaw rate	0,5°/sec

<b>Controller</b>	
Manufacturer	ENERCON
Type	microprocessor
Grid connection	Via ENERCON inverter
Remote communication	ENERCON Remote Monitoring System
UPS	included

<b>Braking System</b>	
Aerodynamic brake	<ul style="list-style-type: none"> <li>- three independent blade pitch systems with emergency supply</li> <li>- rotor brake</li> <li>- rotor lock, locking at 30°</li> </ul>

<b>Tower</b>					
Hub heights	78 m	85 m	98 m	108 m	138 m
Tower	Steel (4 + FS)	Steel + Prefab concrete (2 + 15)	Steel + Prefab concrete (2 + 18)	Steel + Prefab concrete (2 + 21)	Steel + Prefab concrete (2 + 21)
Design Wind Class	II	II	II	II	II

<b>Weights</b>	
Nacelle, excl. Rotor and hub	Approx. 18 to
Rotor incl. Hub/Main pin	Approx. 55 to
Generator	Approx. 62 to
<b>Total Weight</b>	<b>Approx. 135 to</b>

*Sources: Design Assessment, Manufacturers Certificate*

<b>Summary of Test Report</b>																
<b>(Measured hub height of 108 m) /1/</b>																
Basic sheet "Geräusche" (Noise), according to the																
"Technische Richtlinien für Windenergieanlagen, Teil 1: Bestimmung der Schallemissionswerte"																
(Technical Guidelines for Wind Energy Converters, Part 1: Determination of sound emission values)																
Rev. 18 of February 1, 2008 (Editor: Fördergesellschaft Windenergie e.V. Stresemannplatz 4, D-24103 Kiel)																
Extract of Test Report 209244-04.01 IEC																
on noise emission of wind energy converter of type E-82 E2																
General Data						Technical Data (manufacturer's specifications)										
Manufacturer of WEC:		Enercon GmbH				Rated power (generator):		2.300 kW								
Serial number:		82679				Diameter of rotor:		82 m								
Location of WEC (ca.):		26629 Großefehn				Hub height above ground:		108 m								
Geographic co-ordinates:		GK longitude: 34.15.287				Type of tower:		conical tube tower								
		GK latitude: 59.14.701				Power control:		Pitch								
Complementary rotor data (manufacturer's specifications)						Complementary data of gear unit and generator (manufacturer's specifications)										
Manufacturer of rotor blade:		Enercon				Manufacturer of gear unit:		not applicable								
Type of rotor blade:		E-82 E2				Type of gear unit:		not applicable								
Blade setting angle:		variable				Manufacturer of generator:		Enercon								
Number of rotor blades:		3				Type of generator:		E-82 E2								
Rotor speed range:		6 to 18 r.p.m. (mode OM I)				Generator speed range:		6 to 18 r.p.m. (mode OM I)								
Calculated Performance Chart ENERCON E-82 E2; calculated by ENERCON (Rev. 3.0)																
	Reference Point				Noise emission parameters	Observations										
	standardized wind speed in 10 m height		true electrical power													
sound power level $L_{WA,P}$	5 $ms^{-1}$		579 kW		96.4 dB(A)											
	6 $ms^{-1}$		1,089 kW		100.6 dB(A)											
	7 $ms^{-1}$		1,612 kW		102.5 dB(A)											
	8 $ms^{-1}$		2,032 kW		103.2 dB(A)											
	9 $ms^{-1}$		2,255 kW		103.3 dB(A)											
	10 $ms^{-1}$		2,300 kW		102.9 dB(A)											
tonal audibility $\Delta L_{a,k}$	5 $ms^{-1}$		kW		- 2.7 dB											
	6 $ms^{-1}$		kW		<- 3.0 dB											
	7 $ms^{-1}$		kW		- 1.8 dB											
	8 $ms^{-1}$		kW		- 0.7 dB											
	9 $ms^{-1}$		kW		0.2 dB											
	10 $ms^{-1}$		kW		- 0.4 dB											
impulse adjustment for small distances $K_{IN}$	5 $ms^{-1}$		kW		0 dB											
	6 $ms^{-1}$		kW		0 dB											
	7 $ms^{-1}$		kW		0 dB											
	8 $ms^{-1}$		kW		0 dB											
	9 $ms^{-1}$		kW		0 dB											
	10 $ms^{-1}$		kW		0 dB											
Third-octave band sound power level for $v_s = 5 ms^{-1}$ in dB(A)																
Frequency	50	63	80	100	125	160	200	250	315	400	500	630				
$L_{WA,P}$	74.1	76.5*	80.0	85.6	82.2	81.7	81.9	83.7	85.6	85.1	85.5	87.6				
Frequency	800	1,000	1,250	1,600	2,000	2,500	3,150	4,000	5,000	6,300	8,000	10,000				
$L_{WA,P}$	86.9	86.2	84.8	82.4	78.8	75.3	70.6	65.5	60.3*	60.3*	63.0	70.3				
Octave band sound power level for $v_s = 5 ms^{-1}$ in dB(A)																
Frequency	63		125		250		500		1,000		2,000		4,000		8,000	
$L_{WA,P}$	82.3		88.3		88.8		91.0		90.8		84.5		72.1		71.4	
Third-octave band sound power level for $v_s = 6 ms^{-1}$ in dB(A)																
Frequency	50	63	80	100	125	160	200	250	315	400	500	630				
$L_{WA,P}$	78.2**	79.1*	82.2	85.2	87.4	84.3	85.0	87.3	88.7	88.5*	89.5*	93.2				
Frequency	800	1,000	1,250	1,600	2,000	2,500	3,150	4,000	5,000	6,300	8,000	10,000				
$L_{WA,P}$	91.7	91.5	89.9	87.1	83.0	79.4	74.4	69.0	63.5	64.4	67.4	74.3				

Octave band sound power level for $v_s = 6 \text{ ms}^{-1}$ in dB(A)												
Frequency	63	125	250	500	1,000	2,000	4,000	8,000				
L <sub>WA,P</sub>	84.9*	90.6	92.0	95.7	95.9	89.0	75.8	75.4				
Third-octave band sound power level for $v_s = 7 \text{ ms}^{-1}$ in dB(A)												
Frequency	50	63	80	100	125	160	200	250	315	400	500	630
L <sub>WA,P</sub>	78.6**	79.8	82.7	84.8	90.8	86.2	86.0	89.7	91.0	92.5	91.7	93.9
Frequency	800	1,000	1,250	1,600	2,000	2,500	3,150	4,000	5,000	6,300	8,000	10,000
L <sub>WA,P</sub>	93.4	93.3	91.8	89.2	85.8	81.9	77.0	72.2	66.1	65.3	66.8	72.8
Octave band sound power level for $v_s = 7 \text{ ms}^{-1}$ in dB(A)												
Frequency	63	125	250	500	1,000	2,000	4,000	8,000				
L <sub>WA,P</sub>	85.5*	92.8	94.2	97.6	97.7	91.4	78.5	74.4				
Third-octave band sound power level for $v_s = 8 \text{ ms}^{-1}$ in dB(A)												
Frequency	50	63	80	100	125	160	200	250	315	400	500	630
L <sub>WA,P</sub>	77.4*	80.4	83.1	84.9	91.2	86.6	86.3	90.4	91.4	92.9	92.1*	94.8
Frequency	800	1,000	1,250	1,600	2,000	2,500	3,150	4,000	5,000	6,300	8,000	10,000
L <sub>WA,P</sub>	94.2	94.1	92.6	90.1	86.7	82.7	77.8	73.3	67.7	65.8	66.6	71.4
Octave band sound power level for $v_s = 8 \text{ ms}^{-1}$ in dB(A)												
Frequency	63	125	250	500	1,000	2,000	4,000	8,000				
L <sub>WA,P</sub>	85.6	93.2	94.6	98.2	98.5	92.2	79.4	73.4				
Third-octave band sound power level for $v_s = 9 \text{ ms}^{-1}$ in dB(A)												
Frequency	50	63	80	100	125	160	200	250	315	400	500	630
L <sub>WA,P</sub>	78.5	81.4	83.9	85.7	92.6	88.2	86.4	90.2	90.7	91.8	91.5*	93.9
Frequency	800	1,000	1,250	1,600	2,000	2,500	3,150	4,000	5,000	6,300	8,000	10,000
L <sub>WA,P</sub>	94.0	94.4	93.4	91.5	88.4	84.6	79.9	75.4	69.3	65.5*	66.4	71.5
Octave band sound power level for $v_s = 9 \text{ ms}^{-1}$ in dB(A)												
Frequency	63	125	250	500	1,000	2,000	4,000	8,000				
L <sub>WA,P</sub>	86.6	94.6	94.3	97.3*	98.7	93.8	81.5	73.4				
Third-octave band sound power level for $v_s = 10 \text{ ms}^{-1}$ in dB(A)												
Frequency	50	63	80	100	125	160	200	250	315	400	500	630
L <sub>WA,P</sub>	78.8	81.7	84.5	86.3	92.4	88.5	86.4	89.8	90.0*	91.2	90.9*	92.7*
Frequency	800	1,000	1,250	1,600	2,000	2,500	3,150	4,000	5,000	6,300	8,000	10,000
L <sub>WA,P</sub>	93.3	93.9	93.3	91.5	88.8	85.2	80.7	76.5	71.9	70.4	68.5	71.8
Octave band sound power level for $v_s = 10 \text{ ms}^{-1}$ in dB(A)												
Frequency	63	125	250	500	1,000	2,000	4,000	8,000				
L <sub>WA,P</sub>	87.0	94.6	93.7	96.5*	98.3	94.0	82.5	75.2				

This summary of the test report is valid only in combination with the certification of the manufacturer of 03/05/2010.

**These specifications do not replace the test report mentioned above (particularly for noise immission predictions).**

Observations: \* Difference between working and background noise < 6 dB, correction by 1.3 dB  
 \*\* Difference between working and background noise < 3 dB, values shall not be presented

/1/ Wind turbine generator systems – Part 11: Acoustic noise; measurement techniques (IEC 61400-11:2002 and A1:2006);  
 German version DIN EN 61400-11:2007

Measured by: KÖTTER Consulting Engineers  
 - Rheine -



Date: 08/02/2010

i. V. Dipl.-Ing. O. Bunk i. A. Dipl.-Ing. J. Weinheimer



## **ADJACENT WIND FARM**

Siemens states in an email (Youmans, 2011), “The enclosed noise test report [Windtest, 2005] for the SWT 2.3-93 has been used on other applications to demonstrate the lack of any tonal characteristics. A similar report will be issued for the SWT 2.3-101 in the near future, but in the meantime this report has been accepted for proof of tonality since both units share common gearbox, generator, and converter systems.”

Uncertainty in the tonal analysis is mentioned in section 3.6.3 (“Tonality”) of the Windtest (2005) report.

No tonal penalty has been applied to this turbine.

The 10 m broadband and octave band source sound power levels for the Siemens SWT-2.221-101 turbine under its power-reduced operation protocol for a hub height of 99.5 m are shown in Table 1. Note that the ‘Manufacturer’s emission levels’ were only provided for 6 and 8 ms<sup>-1</sup>. For 7-ms<sup>-1</sup>, octave band SPoLs have been interpolated; the 9 and 10-ms<sup>-1</sup> SPoLs have been set equal to the 8-ms<sup>-1</sup> SPoLs.

Table 1 Siemens SWT-2.221-101 – Wind turbine acoustic emissions summary.

<b>Make and Model: Siemens SWT-2.221-101</b>										
<b>Rating: 2,221 kW</b>										
<b>Hub height (m): 99.5</b>										
<b>Wind profile adjustment: summer night-time power-law wind shear coefficient = 0.45</b>										
	<b>Octave band sound power level (dB)</b>									
	<b>Manufacturer’s emission levels (10 m a.g.l.)</b>					<b>Adjusted emission levels (10 m a.g.l.)</b>				
<b>Wind speed (ms<sup>-1</sup>)</b>	<b>6.0</b>	<b>7.0</b>	<b>8.0</b>	<b>9.0</b>	<b>10.0</b>	<b>6.0</b>	<b>7.0</b>	<b>8.0</b>	<b>9.0</b>	<b>10.0</b>
<b>Frequency (Hz)</b>										
<b>63</b>	108.3	n/a	108.6	n/a	n/a	108.6	108.6	108.6	108.6	108.6
<b>125</b>	109.4	n/a	109.1	n/a	n/a	109.1	109.1	109.1	109.1	109.1
<b>250</b>	105.1	n/a	104.6	n/a	n/a	104.6	104.6	104.6	104.6	104.6
<b>500</b>	102.2	n/a	103.0	n/a	n/a	103.0	103.0	103.0	103.0	103.0
<b>1000</b>	99.1	n/a	100.1	n/a	n/a	100.1	100.1	100.1	100.1	100.1
<b>2000</b>	95.4	n/a	95.3	n/a	n/a	95.3	95.3	95.3	95.3	95.3
<b>4000</b>	87.8	n/a	88.6	n/a	n/a	88.6	88.6	88.6	88.6	88.6
<b>8000</b>	85.5	n/a	86.8	n/a	n/a	86.8	86.8	86.8	86.8	86.8
<b>A-weighted</b>	<b>104.5</b>	<b>105.0</b>	<b>105.0</b>	<b>105.0</b>	<b>105.0</b>	<b>105.0</b>	<b>105.0</b>	<b>105.0</b>	<b>105.0</b>	<b>105.0</b>

### 5.1.2 Siemens SWT-2.126-101

Siemens SWT-2.126-101 turbine broadband source sound power level data for 10-m a.g.l. wind speeds of 4 to 12 ms<sup>-1</sup> and octave band source sound power level data for 10-m a.g.l. wind speeds of 6 and 8 ms<sup>-1</sup> are listed in Siemens A/S documents

Table 2 Siemens SWT-2.126-101 – Wind turbine acoustic emissions summary.

<b>Make and Model: Siemens SWT-2.126-101</b>										
<b>Rating: 2,126 kW</b>										
<b>Hub height (m): 99.5</b>										
<b>Wind profile adjustment: summer night-time power-law wind shear coefficient = 0.45</b>										
	<b>Octave band sound power level (dB)</b>									
	<b>Manufacturer's emission levels (10 m a.g.o.)</b>					<b>Adjusted emission levels (10 m a.g.l.)</b>				
<b>Wind speed (ms<sup>-1</sup>)</b>	<b>6.0</b>	<b>7.0</b>	<b>8.0</b>	<b>9.0</b>	<b>10.0</b>	<b>6.0</b>	<b>7.0</b>	<b>8.0</b>	<b>9.0</b>	<b>10.0</b>
<b>Frequency (Hz)</b>										
<b>63</b>	108.8	n/a	108.4	n/a	n/a	108.4	108.4	108.4	108.4	108.4
<b>125</b>	109.7	n/a	108.6	n/a	n/a	108.6	108.6	108.6	108.6	108.6
<b>250</b>	104.7	n/a	103.4	n/a	n/a	103.4	103.4	103.4	103.4	103.4
<b>500</b>	100.5	n/a	101.7	n/a	n/a	101.7	101.7	101.7	101.7	101.7
<b>1000</b>	97.4	n/a	99.1	n/a	n/a	99.1	99.1	99.1	99.1	99.1
<b>2000</b>	94.8	n/a	94.3	n/a	n/a	94.3	94.3	94.3	94.3	94.3
<b>4000</b>	86.9	n/a	88.0	n/a	n/a	88.0	88.0	88.0	88.0	88.0
<b>8000</b>	84.6	n/a	86.2	n/a	n/a	86.2	86.2	86.2	86.2	86.2
<b>A-weighted</b>	<b>103.5</b>	<b>104.0</b>	<b>104.0</b>	<b>104.0</b>	<b>104.0</b>	<b>104.0</b>	<b>104.0</b>	<b>104.0</b>	<b>104.0</b>	<b>104.0</b>

## 5.2 SWEC Wind Turbines

### 5.2.1 Siemens SWT-2.221-101

The 10 m broadband and octave source sound power levels for the Siemens SWT-2.221-101 turbine with a hub height of 80 m are shown in Table 3. These values have been taken directly from the Summerhaven project (draft) Noise Study Report (Golder, 2010). It should be noted that Zephyr North has modified the ‘Adjusted’ octave band source sound power level values for 6 and 7 ms<sup>-1</sup> to match the remaining values at 8, 9 and 10 ms<sup>-1</sup>. It is believed that this will more accurately represent the turbine noise characteristics at the relatively higher hub-height wind speeds corresponding to the 10-m wind speeds which would be driven by the high (0.45) summer night-time wind shear.

Golder (2010) makes no mention of tonality with regard to this turbine. Since this turbine is the same power-derated version of the SWT2.3-101 described for the GREP project, it has been assumed for the purposes of this noise assessment report that there is no tonal noise associated with the Summerhaven turbines. No tonal penalty has been applied.

Golder (2010) reports that a summer night-time vertical wind shear of 0.42 was used for hub-height wind speed adjustments.

# V82-1.65 MW

Creating more from less



**Vestas**



## Optimised for low and medium winds

With its large rotor and powerful generator, the V82 outperforms any turbine in its megawatt class for sites with low and medium wind conditions. Our hydraulic Active-Stall® technology ensures that the rotor gathers the maximum power from the prevailing wind, while minimising loads and controlling output. Active-Stall® provides failsafe protection in all conditions and, at and above its rated wind speed, maintains a steady output of 1.65 MW. With the V82, we have designed a wind turbine that offers unparalleled performance at a cost-effective price.

## Low sound level

Vestas has made a concerted effort to reduce the sound level of the V82 dramatically – with audible results. The operating sound levels are among the lowest on the market,

regardless of wind speed. The V82 also comes with a two-speed generator, which makes it possible to cut sound even further to meet specific requirements, e.g. for night time or low-wind operations.

## Excellent grid compatibility

As wind turbines capture more of the electricity market each year, they have an increasingly significant role to play in grid management. Fortunately, the V82 meets even the most stringent grid demands, and with the installation of our advanced grid compliance system, the V82 will actually help stabilise a weak grid. Vestas grid support features full load and dynamic phase compensation to enhance reactive power regulation and thus keep the power factor in range. It has an uninterrupted backup power supply, too, so that auxiliary systems run at full capacity during grid disturbances. Moreover, our grid support provides continuous active and reactive power regulation to maintain voltage balance in the grid, as well as fault ride-through in the event of disturbances.

## High reliability

Det Norske Veritas (DNV) has certified the V82 as meeting the strictest standards in the wind industry. It has the capacity to tune up its own generator, which helps to give it a particularly high degree of operational availability. In addition, the nacelle is based on the thoroughly tested design of previous models. To date, more than 700 wind turbines featuring this platform design have been installed on sites with conditions ranging from arctic to tropical.

## Proven performance

Wind power plants require substantial investments, and the process can be very complex. To assist in the evaluation and purchasing process, Vestas has identified four factors that are critical to wind turbine quality: energy production, operational availability, power quality and sound level.

We spend months testing and documenting these performance areas for all Vestas turbines. When we are finally satisfied, we ask an independent testing organisation to verify the results – a practice we call Proven Performance. At Vestas we do not just talk about quality. We prove it.

## Technical specifications

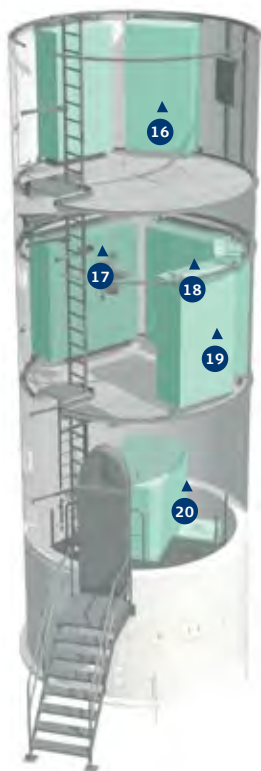
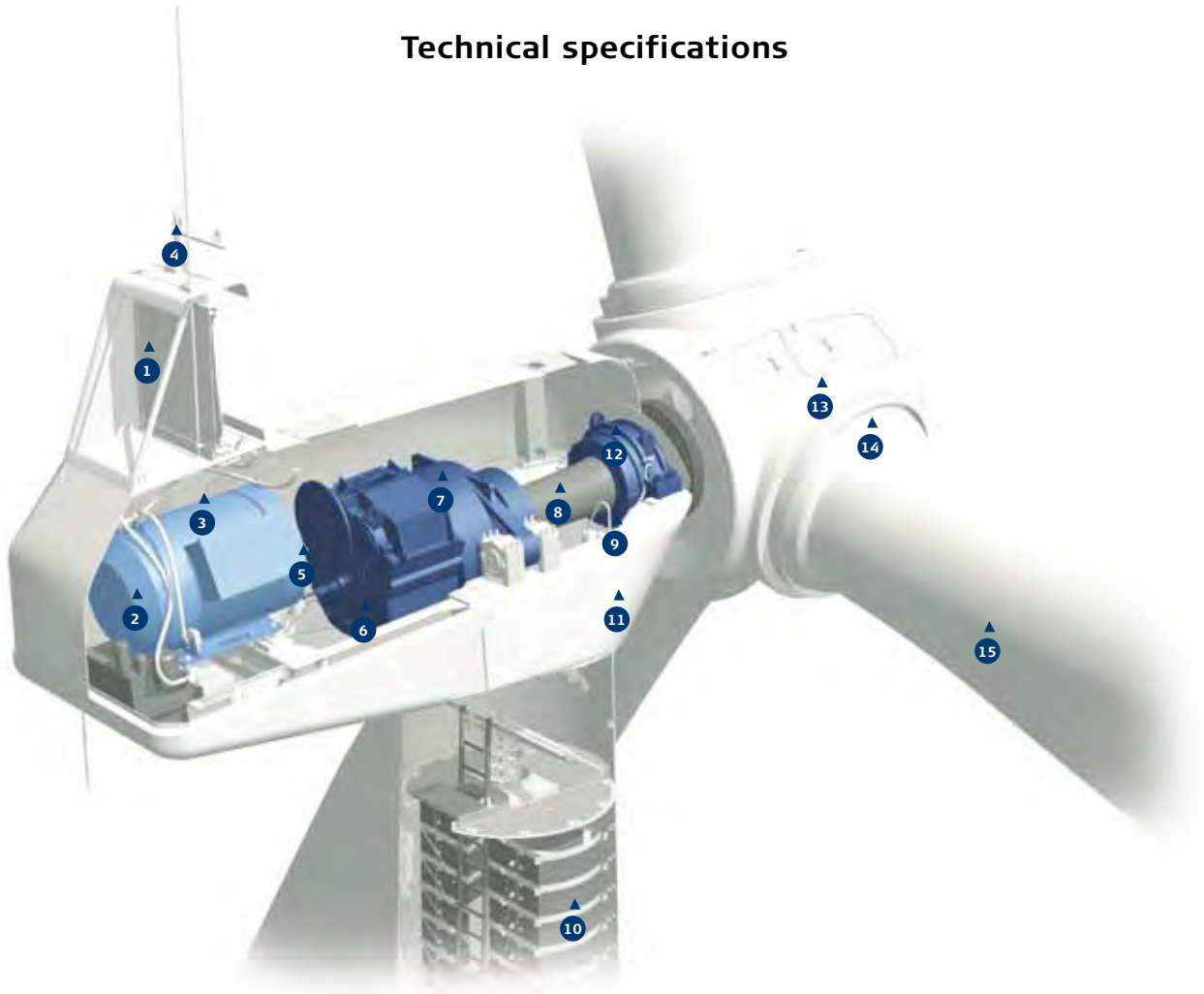

- |                        |  |
|------------------------|--|
| 1 Cooler               | 11 Machine foundation                    |
| 2 Generator            | 12 Main bearing                          |
| 3 Nacelle computer     | 13 Hub computer                          |
| 4 Anemometer windvanes | 14 Pitch system                          |
| 5 Coupling             | 15 Blade                                 |
| 6 Mechanical brake     | 16 Dynamic converter (option)            |
| 7 Gearbox              | 17 Main panel                            |
| 8 Main shaft           | 18 Phase compensation (full load option) |
| 9 Yaw gears            | 19 CPU                                   |
| 10 Tower damper        | 20 Transformer and switchgear            |

Example of tower internal configuration.



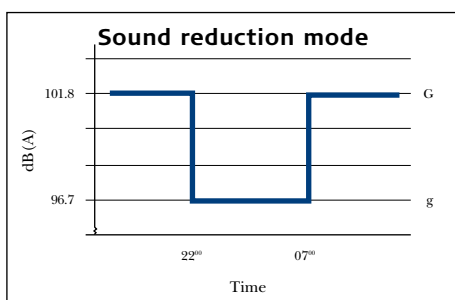
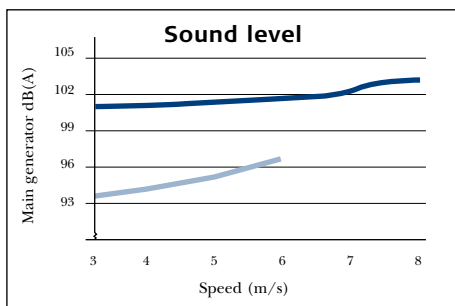
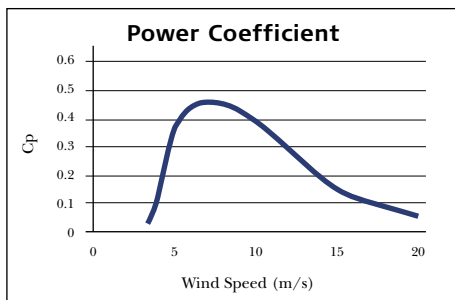
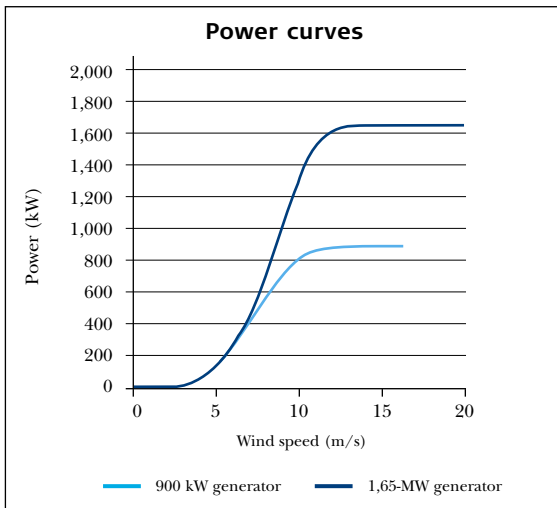

## Rotor

Diameter: 82 m  
 Area swept: 5,281 m<sup>2</sup>  
 Nominal revolutions: 14.4 rpm, 14.4/10.8 rpm  
 Number of blades: 3  
 Power regulation: Active-Stall®  
 Air brake: Full blade pitch by three separate hydraulic pitch cylinders

## Tower

Hub height (approx.): 59 m, 68.5 m, 70 m, 78 m

## Operational data

	IEC IIB: 1,650 kW	IEC IIB: 900 kW/1,650 kW
Cut-in wind speed:	3.5 m/s	2.5 m/s
Nominal wind speed:	13 m/s	13 m/s
Cut-out wind speed (10 minutes):	20 m/s	20 m/s
Cut-out wind speed (1 minute):	24 m/s	24 m/s
Cut-out wind speed (1 second):	32 m/s	32 m/s

## Generator

Type: Asynchronous  
 one or two speed generator water cooled  
 Nominal output: 1,650 kW  
 Operational data: 50/60 Hz  
 690 V

## Gearbox

Type: Planetary/helical stages

## Control

Type: Computer-based control of all turbine functions with the option of remote monitoring. Output regulation and optimisation via Active-Stall®.

## Weight

Nacelle 52 t  
 Rotor 43 t

Towers:  
 Hub height: IEC IIB  
 59 m 75 t  
 68.5 m 105 t  
 70 m 110 t  
 78 m 130 t

t = metric tonnes

All specifications subject to change without notice.

# Creating more from less



Ideally, it makes sense to generate electricity close to where it will be consumed so as to keep transmission, infrastructure and service costs low. However, since populous areas tend to have low winds and stringent requirements on sound levels, the wind industry often concentrates on coastal areas, deserted interiors and the open sea, where the wind is plentiful and sound restrictions are few.

With the V82 wind turbine, Vestas has made it easier to produce electricity close to where people live. Not only is the V82 extremely efficient in areas with low and medium winds, but it also provides the means to adjust sound levels

to suit local requirements. This means that a large number of previously marginal sites can now be exploited profitably – and quietly.

The V82 is an extremely competitive turbine in its class in areas with low and medium winds. A stall-regulated wind turbine, it has been optimised for sites with an average wind speed of just 6.5 m/s at hub height, while a breeze of as little as 2.5 m/s is all that is needed to start production. The V82 is available with either a one or a two-speed generator.

**Vestas Wind Systems A/S**

Alsvej 21  
8900 Randers  
Denmark  
Tel. +45 97 30 00 00  
Fax +45 97 30 00 01  
vestas@vestas.com  
www.vestas.com

To see a complete list of our  
sales and service units, visit  
[www.vestas.com](http://www.vestas.com)

## Kossowski, Julia

---

**From:** Hickey, Maurice <Maurice.Hickey@gdfsuezna.com>  
**Sent:** Wednesday, December 14, 2011 10:43 AM  
**To:** Kossowski, Julia; Gafur, Ansar  
**Cc:** Bultena, Carolyn  
**Subject:** RE: Mohawk Point Coordinates  
**Attachments:** A1-156508-MO-121-0100-Rev6-AsBuilt.pdf

Hi Julia

Please accept my apologies for not getting this to you sooner. It has been hectic as of late.

Please see the attached map with coordinates. The turbines at Mohawk are Vestas V 82-1.65Mw Mark IV 60 Hz units. They have a hub height of 80 meters.

If you need more info please feel free to let me know.

Maurice  
647-271-9753

-----Original Message-----

From: Kossowski, Julia [<mailto:Julia.Kossowski@stantec.com>]  
Sent: December-12-11 9:44 AM  
To: Gafur, Ansar  
Cc: Hickey, Maurice; Bultena, Carolyn  
Subject: RE: Mohawk Point Coordinates

Thank you for the follow-up, Ansar.

Maurice, Carolyn; I would be so thankful if you could provide the coordinates and make/model to me today.

Thanks in advance,  
Julia

Julia Kossowski  
Project Manager  
Stantec  
49 Frederick Street  
Kitchener ON N2H 6M7  
Ph: (519) 569-4338  
Fx: (519) 579-6733  
Cell: (226) 989-5259  
[julia.kossowski@stantec.com](mailto:julia.kossowski@stantec.com)  
[www.stantec.com](http://www.stantec.com)

The content of this email is the confidential property of Stantec and should not be copied, modified, retransmitted, or used for any purpose except with Stantec's written authorization. If you are not the intended recipient, please delete all copies and notify us immediately.

Please consider the environment before printing this email.



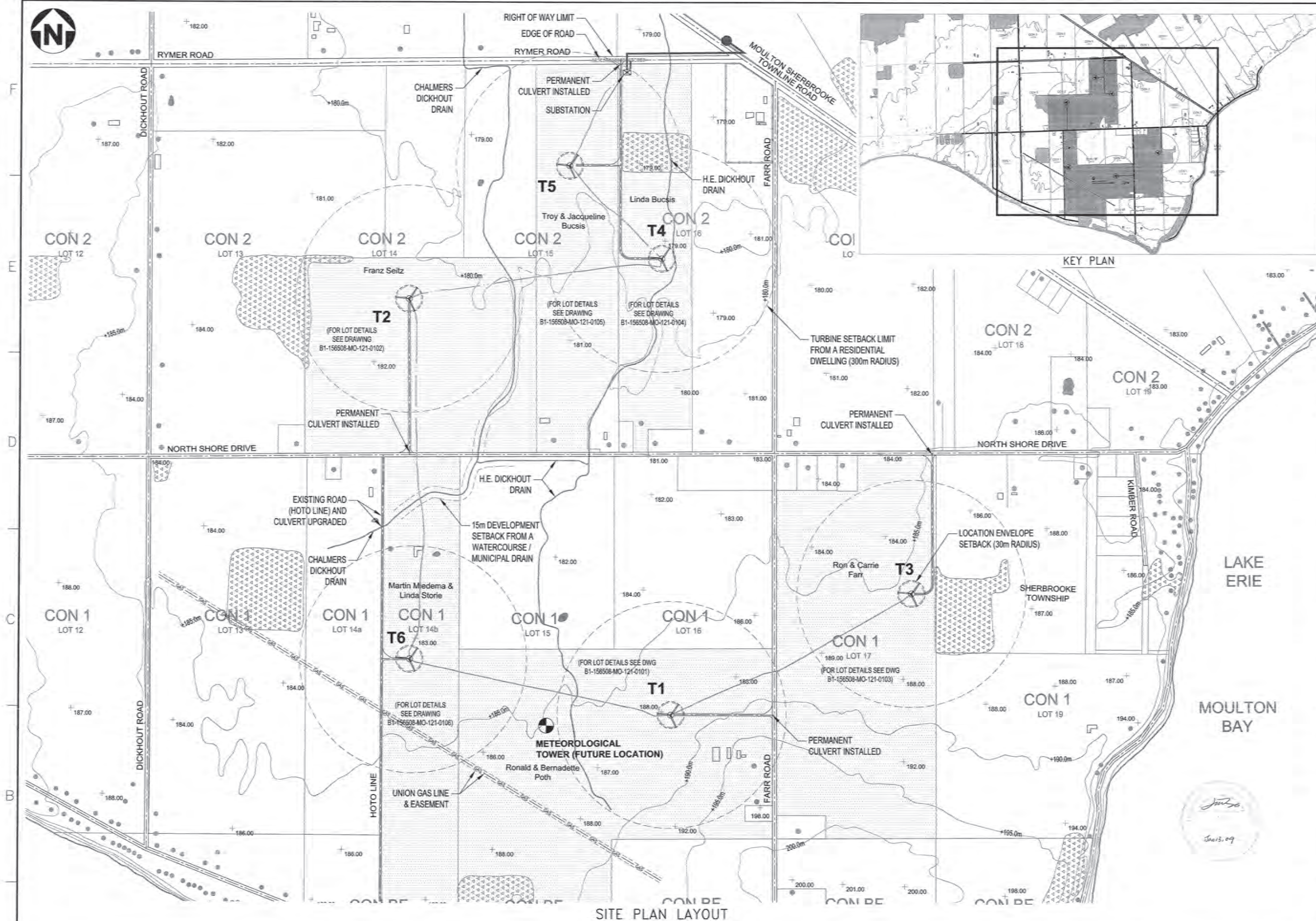

- NOTES:**
- GRID COORDINATES SHOWN ON THIS DRAWING ARE BASED ON NAD 83, ZONE 17.
  - TOPOGRAPHIC INFORMATION AND PROPERTY BOUNDARIES WAS DERIVED FROM MACVRO DRAWINGS #4877-G13A/B/C REV. F APRIL 29, 2005.
  - HOUSE LOCATIONS BASED ON LAYOUT FROM ZEPHYR NORTH RECEIVED ON JANUARY 25th, 2005, (LKE02-21).
  - TURBINE LOCATIONS ARE BASED ON COORDINATES IN EMAIL FROM AM POWER GEN. DATED JUNE 21st, 2007.

- LEGEND**
- TURBINE ACCESS ROAD
  - MAJOR ROADS
  - TURBINE
  - FARM BUILDING
  - EXIST. RESIDENTIAL DWELLING
  - EXISTING WOODED AREA
  - MUNICIPAL DRAIN
  - 27.6KV OVERHEAD COLLECTOR LINE TO EXISTING 27.6KV HONI OVERHEAD LINE
  - 27.6KV OVERHEAD COLLECTOR LINE & FIBRE OPTIC CABLE
  - 27.6KV UNDERGROUND & FIBRE OPTIC CABLE
  - 300m TURBINE SETBACK FROM AN OFF-SITE RESIDENTIAL DWELLING
  - SPOT HEIGHT ELEVATION

MOHAWK TURBINE COORDINATES	
TURBINE #	COORDINATES (E, N)
T1	E 623355, N 4745400
T2	E 622632, N 4746480
T3	E 623974, N 4745737
T4	E 623297, N 4746604
T5	E 623047, N 4746843
T6	E 622661, N 4745529



AMEC - BLACK & McDONALD  
JOINT VENTURE

**PowerGen Corporation**

AREA MO: LAKE ERIE S.O.C. PROJECTS  
MOHAWK POINT WIND FARM

SUBJECT: SITE PLAN LAYOUT

CLIENT DWG NO.:

DRAWING NO. A1-156508-MO-121-0100

REV. 6

REV	DATE	DESCRIPTION	ISS	CHK	APP	APP	APP	APP	ISS	DATE	DESCRIPTION	ISS	CHK	APP	APP	APP	APP	ISS	DATE	DESCRIPTION
6	13/01/09	AS BUILT								6	13/01/09	AS BUILT								
5	19/06/08	ISSUED FOR AS BUILT	MRH	SL	OG					5	19/06/08	OG								
4	14/05/08	ISSUED FOR AS BUILT	MRH	SL	OG					4	14/05/08	OG								
3	12/11/07	ISSUED FOR CONSTRUCTION	MRH	SL	OG					3	12/11/07	OG								
2	02/11/07	ISSUED FOR MUNICIPAL SITE PLAN APPROVAL	MRH	SL	OG					2	02/11/07	OG								
1	15/10/07	ISSUED FOR CONSTRUCTION	MRH	MP	OG					1	15/10/07	OG								
0	23/08/07	ISSUED FOR MUNICIPAL SITE PLAN APPROVAL	MRH	MP	OG					0	23/08/07	OG								

STAMP/SEAL

PROPRIETARY INFORMATION: THIS DRAWING IS THE PROPERTY OF AMEC AMERICAS, INC. AND IS NOT TO BE LOANED OR REPRODUCED IN ANY WAY WITHOUT THE PERMISSION OF AMEC AMERICAS, INC.

CLIENT PROJECT MGR. ENGINEERING MGR. PROJECT MGR.

PROJECT PHASE

PROJECT NO. 156508 ACTIVITY NO. PACKAGE CODE

SCALE 1:5000

BY: G.GRAHN D/M/Y JUNE '07

DRN: M.HALL



## 1.0 Wind Turbine Specifications Report

The HAF Wind Energy Project (“the Project”) is proposed to consist of five (5) Vestas V100-1.8MW turbines. The turbine model was selected based upon its technical performance, design characteristics, acoustic properties, power output, and site specific considerations.

The purpose of this report is to provide the technical information on the turbines to be used for the proposed Project. The Vineland Power Inc. is proposing a single Class 4 Wind Energy Facility consisting of five 1.8 MW wind turbines for a total nameplate capacity of 9.0 MW in the Township of West Lincoln in Niagara Region of the Province of Ontario.

### 1.1 Technical Specifications

The Vestas V100-1.8 MW wind turbine is a pitch regulated upwind turbine with active yaw and a three-blade rotor. The Vestas V100-1.8 MW turbine has a rotor diameter of 100 m with a generator rated at 1.8 MW. The turbine utilizes a microprocessor pitch control system called OptiTip®. With these features the wind turbine is able to optimize power output at different wind speeds.

A summary of the technical specifications is presented in **Table 1.1** with additional information provided by the manufacturer is included in **Appendix 1**.

Table 1.1a: Summary of Technical Specifications of the Vestas V100-1.8MW	
Specification	Vestas V100-1.8MW
Nameplate Capacity	1.8 Megawatt
Hub Height (above grade)	95 m
Rotator Diameter	100 m
Blade Length	49 m
Swept Area	7850 m <sup>2</sup>
Minimum Wind Speed (cut-in speed)	4.0 m/s
Maximum Wind Speed (cut-out speed)	20.0 m/s
Dynamic Rotational Speed Range	9.3 rpm to 16.6 rpm
Actual Rotational Speed	14.9 rpm

Each Vestas V100 turbine has a nameplate capacity of 1.8 MW and will be built to a hub height of 95 meters. The rotor diameter is 100 meters with swept area of 7850 m<sup>2</sup>.

The minimum operational wind speed (cut-in speed) is 4.0 m/s with a maximum operational speed (cut-out speed) of 20.0 m/s.

The V-100 Turbine is erected on a tabular steel tower which holds the nacelle at 95 meters above the ground. The nacelle houses the hub and electrical components. Each blade is constructed of light weight airfoil shells bonded to supporting beams



and connect to the hub forming a 100 meter rotor. The generator is asynchronous with wound rotor, slip rings and VCUS. The turbine’s operational envelope is -20° to +40° C.

**Table 1.1b** summarizes the Wind Turbine General Specifications.

<b>Table 1.1b: Wind Turbine General Specifications</b>	
	<b>Operational Envelope: -20° to +40° C</b>
<b>Rotor</b>	<b>Rotor Diameter: 100m</b>
	<b>Swept Area: 7850m<sup>2</sup></b>
	<b>Speed, Dynamic Operation Range: 9.3 - 16.6 rpm</b>
	<b>Rotational Direction: Clockwise (front view)</b>
<b>Tower</b>	<b>Type: tubular steel tower</b>
	<b>Hub: 95m</b>
<b>Electrical</b>	<b>Frequency: 60 Hz</b>
	<b>Rated Power: 1.8 MW</b>
	<b>Generator: Asynchronous with wound rotor, slip rings and VCUS</b>
<b>Blade</b>	<b>Type: airfoil shells bonded to supporting beam</b>
	<b>Length: 49m</b>
	<b>Max Chord: 3.9m</b>
<b>Nacelle</b>	<b>Height for Transport: 4.0 m</b>
	<b>Height Installed: 5.4 m</b>
	<b>Width: 3.4 m</b>
	<b>Length: 10.4 m</b>
<b>Hub</b>	<b>Material: cast ball shell hub</b>
	<b>Height: 95m</b>
	<b>Diameter: 3.3 m</b>

## 1.2 Acoustic Emissions Data

The V100 1.8 MW turbine model has a maximum sound power rating of **105.00 dBA**. Additional information on the acoustic data can be found in **Tables 1.2a, 1.2b, 1.2c, and 1.3**. These tables summarize the wind turbine specifications provided in the Manufacture Technical Details provided in **Appendix 1**.

**Table 1-2a** provides the Sound Power Level Ratings (dBA) for **Mode 0** at a Hub Height of **95 meters**. The table shows the conditions for sound power levels at speeds of **3 m/s to 13 m/s at 10 meters** with the corresponding wind speed at hub height (HH). The sound power rating does not exceed 105.00 dBA.

Table 1-2a: Sound Power Level Ratings for Mode 0		
Conditions for Sound Power Level	Hub Height 95 meters	Wind speed at hh [m/sec]
LwA @ 3 m/s (10 m above ground) [dBA]	93.8	4.3
LwA @ 4 m/s (10 m above ground) [dBA]	96.4	5.7
LwA @ 5 m/s (10 m above ground) [dBA]	100.7	7.2
LwA @ 6 m/s (10 m above ground) [dBA]	104.4	8.6
LwA @ 7 m/s (10 m above ground) [dBA]	105.0	10.0
LwA @ 8 m/s (10 m above ground) [dBA]	105.0	11.5
LwA @ 9 m/s (10 m above ground) [dBA]	105.0	12.9
LwA @ 10 m/s (10 m above ground) [dBA]	105.0	14.3
LwA @ 11 m/s (10 m above ground) [dBA]	105.0	15.8
LwA @ 12 m/s (10 m above ground) [dBA]	105.0	17.2
LwA @ 13 m/s (10 m above ground) [dBA]	105.0	18.6

**Table 1-2b** (below) provides the Sound Power Level Ratings (dBA) for **Mode 1** at a Hub Height of **95 meters**. The table shows the conditions for sound power levels at speeds of **3 m/s to 13 m/s at 10 meters** with the corresponding wind speed at hub height (HH). The sound power rating does not exceed 105.00 dBA.

Table 1-2b: Sound Power Level Ratings for Mode 1		
Conditions for Sound Power Level	Hub Height 95 meters	Wind speed at hh [m/sec]
LwA @ 3 m/s (10 m above ground) [dBA]	93.7	4.3
LwA @ 4 m/s (10 m above ground) [dBA]	95.7	5.7
LwA @ 5 m/s (10 m above ground) [dBA]	99.7	7.2
LwA @ 6 m/s (10 m above ground) [dBA]	103.4	8.6
LwA @ 7 m/s (10 m above ground) [dBA]	105.0	10.0
LwA @ 8 m/s (10 m above ground) [dBA]	105.0	11.5
LwA @ 9 m/s (10 m above ground) [dBA]	105.0	12.9
LwA @ 10 m/s (10 m above ground) [dBA]	105.0	14.3
LwA @ 11 m/s (10 m above ground) [dBA]	105.0	15.8
LwA @ 12 m/s (10 m above ground) [dBA]	105.0	17.2
LwA @ 13 m/s (10 m above ground) [dBA]	105.0	18.6

Table 1-2c provides the Sound Power Level Ratings (dBA) for **Mode 2** at a Hub Height of **95 meters**. The table shows the conditions for sound power levels at speeds of **3 m/s** to **13 m/s** at **10 meters** with the corresponding wind speed at hub height (HH). The sound power rating does not exceed 105.00 dBA.

Table 1-2c: Sound Power Level Ratings for Mode 2		
Conditions for Sound Power Level	Hub Height 95 meters	Wind speed at hh [m/sec]
LwA @ 3 m/s (10 m above ground) [dBA]	93.8	4.3
LwA @ 4 m/s (10 m above ground) [dBA]	96.4	5.7
LwA @ 5 m/s (10 m above ground) [dBA]	100.7	7.2
LwA @ 6 m/s (10 m above ground) [dBA]	103.0	8.6
LwA @ 7 m/s (10 m above ground) [dBA]	103.0	10.0
LwA @ 8 m/s (10 m above ground) [dBA]	103.0	11.5
LwA @ 9 m/s (10 m above ground) [dBA]	103.0	12.9
LwA @ 10 m/s (10 m above ground) [dBA]	103.0	14.3
LwA @ 11 m/s (10 m above ground) [dBA]	103.0	15.8
LwA @ 12 m/s (10 m above ground) [dBA]	103.0	17.2
LwA @ 13 m/s (10 m above ground) [dBA]	103.0	18.6

**Table 1-3** provides the Octave Band Spectra showing Octave in Hz from **16 Hz** to **8000 Hz** with the corresponding Sound Power Level in dB(A). Sound Power Level does not exceed **99.7 dB**.

Table 1-3: Octave Band Spectra												
Wind Speed@10m [m/s]	3	4	5	6	7	8	9	10	11	12	13	14
<b>16Hz [dB(A)]</b>	NaN	NaN	NaN	NaN	NaN	NaN	NaN	NaN	NaN	NaN	NaN	NaN
<b>31.5Hz [dB(A)]</b>	NaN	NaN	NaN	NaN	NaN	NaN	NaN	NaN	NaN	NaN	NaN	NaN
<b>63Hz [dB(A)]</b>	NaN	NaN	NaN	85.2	87.4	87.1	86.7	86.6	NaN	NaN	NaN	NaN
<b>125Hz [dB(A)]</b>	NaN	NaN	NaN	89.6	92	91.7	91.3	91.4	NaN	NaN	NaN	NaN
<b>250Hz [dB(A)]</b>	NaN	NaN	NaN	93	94.7	94.2	93.6	93.5	NaN	NaN	NaN	NaN
<b>500Hz [dB(A)]</b>	NaN	NaN	NaN	95.4	97.1	96.7	96.1	96.1	NaN	NaN	NaN	NaN
<b>1000Hz [dB(A)]</b>	NaN	NaN	NaN	98.2	99.7	99.5	99	99.1	NaN	NaN	NaN	NaN
<b>2000Hz [dB(A)]</b>	NaN	NaN	NaN	96.6	98.2	98.4	98.2	98.2	NaN	NaN	NaN	NaN
<b>4000Hz [dB(A)]</b>	NaN	NaN	NaN	94.6	96.6	97.2	98.7	98.6	NaN	NaN	NaN	NaN
<b>8000Hz [dB(A)]</b>	NaN	NaN	NaN	85.4	89.8	90.3	91.4	92.3	NaN	NaN	NaN	NaN

**Table 1-3 Notes:**

1. "NaN" indicates data not available due to insufficient data collection at this wind speed.
2. Disclaimers from Vestas: The values are valid for the A-weighted sound power levels  
Octave band values must be regarded as informative  
Site specific values are not warranted
3. Measurement standard ICE 6140011:2002, using amendments procedure above 95% RP

### 1.3 Qualifications and Limitations

This summary report was produced, in part, to fulfill the requirements for the Turbine Specifications Report for the Renewable Energy Approval (REA). The contents of this document have been produced using the requirements outlined in O.Reg 359/09 as well as other applicable Acts and Regulations governing these projects.

Morrison Hershfield Limited's assessment was made in accordance with guidelines, regulations and procedures believed to be current at this time. Changes in guidelines, regulations and policies can occur at the discretion of the government and such changes could affect this report.

Morrison Hershfield Limited and the consulting team retained for this Project have prepared this report in accordance with information provided by its Client and their representatives. While we may have referred to and made use of this information and reporting, we assume no liability for the accuracy of this information.



Search

- Wind Energy
- Wind Farms
- Municipalities
- Media Centre
- Conference & Events
- About Us



WIND FARMS MENU

- Overview
- Planning a Wind Farm
- List of Wind Farms in Canada
- Wind Projection
- Spread the Word
- Case Studies

Wind Farms

home > wind farms

Dunnville Wind Turbine

Date Installed: 2006/10

Turbines: 1x Pfleiderer 650 kW

Total Installed Capacity (MW): 0.6500

Company: Rosa Flora Limited

Address: , Dunneville, ON, , Canada

**Description:** "At Rosa Flora we are constantly working towards reducing our fossil fuel requirements. We have achieved significant energy savings by implementing the latest green technologies. By switching from natural gas boilers to biomass-fueled boilers, we have minimized the net carbon dioxide produced, as the biomass is a carbon dioxide neutral fuel. We also have a co-generation system and wind turbine, which provide us with alternative sources of electricity, reducing our reliance on fossil fuels."

In early 2006, we investigated the possibility of installing a wind turbine for our operations. Our interest in green energy technologies coupled with rising electricity prices prompted us to pursue a wind turbine that was the right size and fit. In February 2006, we purchased a brand new German engineered wind turbine - PWE650. By September 2006, we had the turbine commissioned and were producing 615 kW of electricity per kWh. The electricity is delivered directly into the Rosa Flora system and offsets electricity required from the Ontario grid."

Map

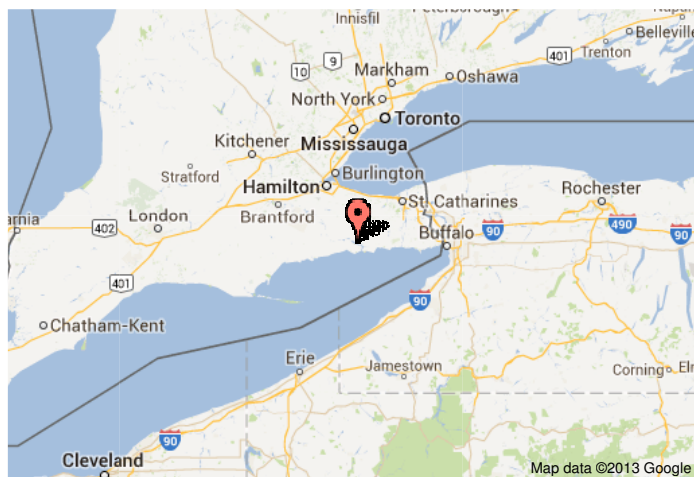

**Stay Informed**  
Knowledge is power! CanWEA delivers news on the latest developments in the Canadian wind energy industry. [Learn more.](#)

**Did you know?**  
Migratory routes of birds are taken into account when siting wind farms.



*WindSight Spring 2013*  
Answering questions about wind energy

**Table F1 Wind Turbine Sound Emission Summary**

**Make and Farm: German engineered wind turbine - PWE650 - Rosa Flora (See Attachment)**

**Model: PWE650**

**Electrical Rating: 650 kW**

**Hub Height: 75 m**

**Data Source: CANWEA; taken higher sound level than three time the power capacity turbine E82 (2.3 MW) Model**

**Octave Band Sound Power Level (dB ref. 10<sup>-12</sup> Watts)**

		Manufacturer's Emission Level					Adjusted Emission Level				
10m Height Wind Speed (m/s)		6	7	8	9	10	6	7	8	9	10
Frequency (Hz)	63	n/a	n/a	n/a	n/a	n/a	113.8	113.8	113.8	113.8	113.8
	125	n/a	n/a	n/a	n/a	n/a	111.3	111.3	111.3	111.3	111.3
	250	n/a	n/a	n/a	n/a	n/a	102.9	102.9	102.9	102.9	102.9
	500	n/a	n/a	n/a	n/a	n/a	100.3	100.3	100.3	100.3	100.3
	1000	n/a	n/a	n/a	n/a	n/a	98.9	98.9	98.9	98.9	98.9
	2000	n/a	n/a	n/a	n/a	n/a	93.4	93.4	93.4	93.4	93.4
	4000	n/a	n/a	n/a	n/a	n/a	82.1	82.1	82.1	82.1	82.1
	8000	n/a	n/a	n/a	n/a	n/a	76.9	76.9	76.9	76.9	76.9
Overall (dBA ref. 10 <sup>-12</sup> Watts)		--	--	--	--	--	103.5	103.5	103.5	103.5	103.5



## WIND TURBINE SPECIFICATION REPORT

### 1.0 Wind Turbine Specifications Report

The Wainfleet Wind Energy Project (“the Project”) is proposed to consist of five (5) Vestas V100-1.8MW turbines. The turbine model was selected based upon its technical performance, design characteristics, acoustic properties, power output, and site specific considerations.

The purpose of this report is to provide the technical information on the turbines to be used for the proposed Project. The Wainfleet Wind Energy Inc. is proposing a single Class 4 Wind Energy Facility consisting of five 1.8 MW wind turbines for a total nameplate capacity of 9.0 MW in the Township of Wainfleet in Niagara Region of the Province of Ontario.

#### 1.1 Technical Specifications

The Vestas V100-1.8 MW wind turbine is a pitch regulated upwind turbine with active yaw and a three-blade rotor. The Vestas V100-1.8 MW turbine has a rotor diameter of 100 m with a generator rated at 1.8 MW. The turbine utilizes a microprocessor pitch control system called OptiTip®. With these features the wind turbine is able to optimize power output at different wind speeds.

A summary of the technical specifications is presented in **Table 1.1** with additional information provided by the manufacturer is included in **Appendix 1**.

<b>Table 1.1a: Summary of Technical Specifications of the Vestas V100-1.8MW</b>	
<b>Specification</b>	<b>Vestas V100-1.8MW</b>
Nameplate Capacity	1.8 Megawatt
Hub Height (above grade)	95 m
Rotator Diameter	100 m
Blade Length	49 m
Swept Area	7850 m <sup>2</sup>
Minimum Wind Speed (cut-in speed)	4.0 m/s
Maximum Wind Speed (cut-out speed)	20.0 m/s
Dynamic Rotational Speed Range	9.3 rpm to 16.6 rpm
Actual Rotational Speed	14.9 rpm

Each Vestas V100 turbine has a nameplate capacity of 1.8 MW and will be built to a hub height of 95 meters. The rotor diameter is 100 meters with swept area of 7850 m<sup>2</sup>.

The minimum operational wind speed (cut-in speed) is 4.0 m/s with a maximum operational speed (cut-out speed) of 20.0 m/s.

The V-100 Turbine is erected on a tubular steel tower which holds the nacelle at 95 meters above the ground. The nacelle houses the hub and electrical components. Each blade is constructed of light weight airfoil shells bonded to supporting beams

WIND TURBINE SPECIFICATION REPORT

and connect to the hub forming a 100 meter rotor. The generator is asynchronous with wound rotor, slip rings and VCUS. The turbine's operational envelope is -20° to +40° C.

**Table 1.1b** summarizes the Wind Turbine General Specifications.

<b>Table 1.1b: Wind Turbine General Specifications</b>	
	<b>Operational Envelope: -20° to +40° C</b>
<b>Rotor</b>	<b>Rotor Diameter: 100m</b>
	<b>Swept Area: 7850m<sup>2</sup></b>
	<b>Speed, Dynamic Operation Range: 9.3 - 16.6 rpm</b>
	<b>Rotational Direction: Clockwise (front view)</b>
<b>Tower</b>	<b>Type: tubular steel tower</b>
	<b>Hub: 95m</b>
<b>Electrical</b>	<b>Frequency: 60 Hz</b>
	<b>Rated Power: 1.8 MW</b>
	<b>Generator: Asynchronous with wound rotor, slip rings and VCUS</b>
<b>Blade</b>	<b>Type: airfoil shells bonded to supporting beam</b>
	<b>Length: 49m</b>
	<b>Max Chord: 3.9m</b>
<b>Nacelle</b>	<b>Height for Transport: 4.0 m</b>
	<b>Height Installed: 5.4 m</b>
	<b>Width: 3.4 m</b>
	<b>Length: 10.4 m</b>
<b>Hub</b>	<b>Material: cast ball shell hub</b>
	<b>Height: 95m</b>
	<b>Diameter: 3.3 m</b>

## 1.2 Acoustic Emissions Data

The V100 1.8 MW turbine model has a maximum sound power rating of **105.00 dBA**. Additional information on the acoustic data can be found in **Tables 1.2a, 1.2b, 1.2c, and 1.3**. These tables summarize the wind turbine specifications provided in the Manufacture Technical Details provided in **Appendix 1**.

**Table 1-2a** provides the Sound Power Level Ratings (dBA) for **Mode 0** at a Hub Height of **95 meters**. The table shows the conditions for sound power levels at speeds of **3 m/s to 13 m/s at 10 meters** with the corresponding wind speed at hub height (HH). The sound power rating does not exceed 105.00 dBA.

Table 1-2a: Sound Power Level Ratings for Mode 0		
Conditions for Sound Power Level	Hub Height 95 meters	Wind speed at hh [m/sec]
LwA @ 3 m/s (10 m above ground) [dBA]	93.8	4.3
LwA @ 4 m/s (10 m above ground) [dBA]	96.4	5.7
LwA @ 5 m/s (10 m above ground) [dBA]	100.7	7.2
LwA @ 6 m/s (10 m above ground) [dBA]	104.4	8.6
LwA @ 7 m/s (10 m above ground) [dBA]	105.0	10.0
LwA @ 8 m/s (10 m above ground) [dBA]	105.0	11.5
LwA @ 9 m/s (10 m above ground) [dBA]	105.0	12.9
LwA @ 10 m/s (10 m above ground) [dBA]	105.0	14.3
LwA @ 11 m/s (10 m above ground) [dBA]	105.0	15.8
LwA @ 12 m/s (10 m above ground) [dBA]	105.0	17.2
LwA @ 13 m/s (10 m above ground) [dBA]	105.0	18.6

**Table 1-2b** (below) provides the Sound Power Level Ratings (dBA) for **Mode 1** at a Hub Height of **95 meters**. The table shows the conditions for sound power levels at speeds of **3 m/s to 13 m/s at 10 meters** with the corresponding wind speed at hub height (HH). The sound power rating does not exceed 105.00 dBA.

WIND TURBINE SPECIFICATION REPORT

Table 1-2b: Sound Power Level Ratings for Mode 1		
Conditions for Sound Power Level	Hub Height 95 meters	Wind speed at hh [m/sec]
LwA @ 3 m/s (10 m above ground) [dBA]	93.7	4.3
LwA @ 4 m/s (10 m above ground) [dBA]	95.7	5.7
LwA @ 5 m/s (10 m above ground) [dBA]	99.7	7.2
LwA @ 6 m/s (10 m above ground) [dBA]	103.4	8.6
LwA @ 7 m/s (10 m above ground) [dBA]	105.0	10.0
LwA @ 8 m/s (10 m above ground) [dBA]	105.0	11.5
LwA @ 9 m/s (10 m above ground) [dBA]	105.0	12.9
LwA @ 10 m/s (10 m above ground) [dBA]	105.0	14.3
LwA @ 11 m/s (10 m above ground) [dBA]	105.0	15.8
LwA @ 12 m/s (10 m above ground) [dBA]	105.0	17.2
LwA @ 13 m/s (10 m above ground) [dBA]	105.0	18.6

Table 1-2c provides the Sound Power Level Ratings (dBA) for **Mode 2** at a Hub Height of **95 meters**. The table shows the conditions for sound power levels at speeds of **3 m/s** to **13 m/s** at **10 meters** with the corresponding wind speed at hub height (HH). The sound power rating does not exceed 105.00 dBA.

Table 1-2c: Sound Power Level Ratings for Mode 2		
Conditions for Sound Power Level	Hub Height 95 meters	Wind speed at hh [m/sec]
LwA @ 3 m/s (10 m above ground) [dBA]	93.8	4.3
LwA @ 4 m/s (10 m above ground) [dBA]	96.4	5.7
LwA @ 5 m/s (10 m above ground) [dBA]	100.7	7.2
LwA @ 6 m/s (10 m above ground) [dBA]	103.0	8.6
LwA @ 7 m/s (10 m above ground) [dBA]	103.0	10.0
LwA @ 8 m/s (10 m above ground) [dBA]	103.0	11.5
LwA @ 9 m/s (10 m above ground) [dBA]	103.0	12.9
LwA @ 10 m/s (10 m above ground) [dBA]	103.0	14.3
LwA @ 11 m/s (10 m above ground) [dBA]	103.0	15.8
LwA @ 12 m/s (10 m above ground) [dBA]	103.0	17.2
LwA @ 13 m/s (10 m above ground) [dBA]	103.0	18.6

WIND TURBINE SPECIFICATION REPORT

**Table 1-3** provides the Octave Band Spectra showing Octave in Hz from **16 Hz** to **8000 Hz** with the corresponding Sound Power Level in dB(A). Sound Power Level does not exceed **99.7 dB**.

Wind Speed@10m [m/s]	3	4	5	6	7	8	9	10	11	12	13	14
<b>16Hz [dB(A)]</b>	NaN	NaN	NaN	NaN	NaN	NaN	NaN	NaN	NaN	NaN	NaN	NaN
<b>31.5Hz [dB(A)]</b>	NaN	NaN	NaN	NaN	NaN	NaN	NaN	NaN	NaN	NaN	NaN	NaN
<b>63Hz [dB(A)]</b>	NaN	NaN	NaN	85.2	87.4	87.1	86.7	86.6	NaN	NaN	NaN	NaN
<b>125Hz [dB(A)]</b>	NaN	NaN	NaN	89.6	92	91.7	91.3	91.4	NaN	NaN	NaN	NaN
<b>250Hz [dB(A)]</b>	NaN	NaN	NaN	93	94.7	94.2	93.6	93.5	NaN	NaN	NaN	NaN
<b>500Hz [dB(A)]</b>	NaN	NaN	NaN	95.4	97.1	96.7	96.1	96.1	NaN	NaN	NaN	NaN
<b>1000Hz [dB(A)]</b>	NaN	NaN	NaN	98.2	99.7	99.5	99	99.1	NaN	NaN	NaN	NaN
<b>2000Hz [dB(A)]</b>	NaN	NaN	NaN	96.6	98.2	98.4	98.2	98.2	NaN	NaN	NaN	NaN
<b>4000Hz [dB(A)]</b>	NaN	NaN	NaN	94.6	96.6	97.2	98.7	98.6	NaN	NaN	NaN	NaN
<b>8000Hz [dB(A)]</b>	NaN	NaN	NaN	85.4	89.8	90.3	91.4	92.3	NaN	NaN	NaN	NaN

Table 1-3 Notes:

1. "NaN" indicates data not available due to insufficient data collection at this wind speed.
2. Disclaimers from Vestas: The values are valid for the A-weighted sound power levels  
Octave band values must be regarded as informative  
Site specific values are not warranted
3. Measurement standard ICE 6140011:2002, using amendments procedure above 95% RP

### 1.3 Qualifications and Limitations

This summary report was produced, in part, to fulfill the requirements for the Turbine Specifications Report for the Renewable Energy Approval (REA). The contents of this document have been produced using the requirements outlined in O.Reg 359/09 as well as other applicable Acts and Regulations governing these projects.

Morrison Hershfield Limited's assessment was made in accordance with guidelines, regulations and procedures believed to be current at this time. Changes in guidelines, regulations and policies can occur at the discretion of the government and such changes could affect this report.

Morrison Hershfield Limited and the consulting team retained for this Project have prepared this report in accordance with information provided by its Client and their representatives. While we may have referred to and made use of this information and reporting, we assume no liability for the accuracy of this information.

## **TRANSFORMER BARRIER COORDINATES**



COORDINATE ARE BASE ON ACAD  
SURVEY DRAWING  
E=621960.000  
N=4761728.000

E=621952.906  
N=4761722.650

E=621952.906  
N=4761733.350

E=621967.206  
N=4761722.650

E=621967.206  
N=4761733.350

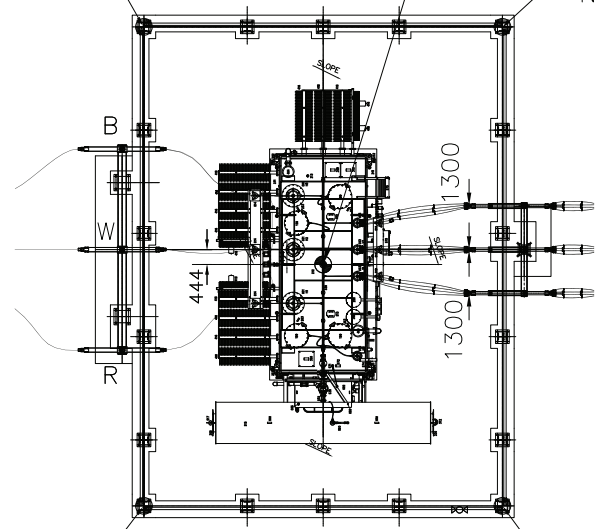

NORTH STATION  
SCALE 1:200

E=622831.650  
N=4754686.237

E=622837.000  
N=4754679.000

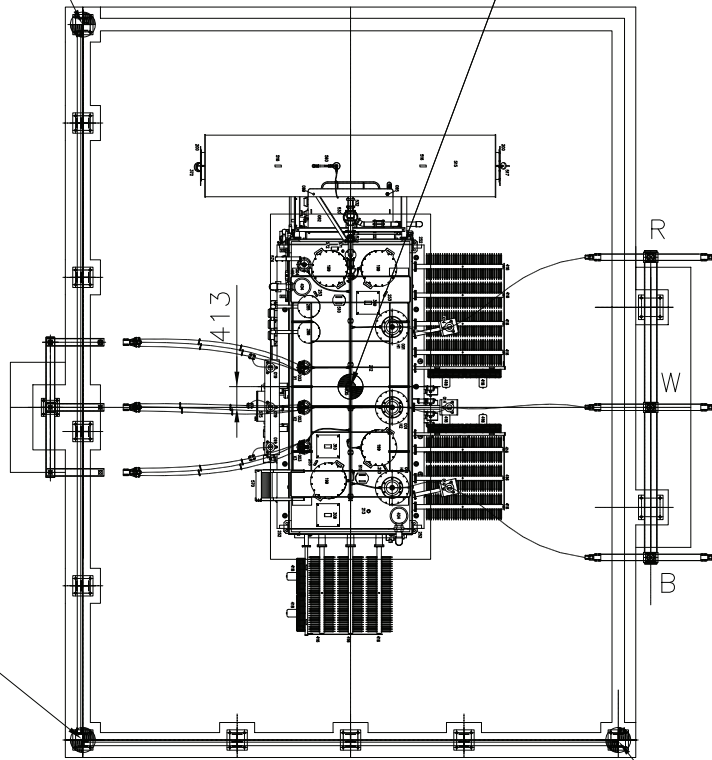

E=622831.650  
N=4754671.937

E=622842.350  
N=4754671.937

SOUTH STATION  
SCALE 1:150

1. Substation ST1 (100/133/166 ONAN/ONAF/ONAF MVA Transformer noise source modeled at a height of 3.7m with UTM Coordinates 621960, 4761728) will require a four sided barrier of 5 metres in height above grade. Barrier corner coordinates are:

***Four sided barrier's 4 corner points are provided below***

<b>4 corners</b>	<b>Easting [m]</b>	<b>Northing [m]</b>
<b>Corner 1</b>	621957	4761731
<b>Corner 2</b>	621957	4761723
<b>Corner 3</b>	621964	4761723
<b>Corner 4</b>	621964	4761732

2. Substation ST2 (100/133/166 ONAN/ONAF/ONAF MVA Transformer noise source modeled at a height of 3.7m with UTM Coordinates 622837, 4754679) will require a two sided barrier of 5 metres in height above grade. This barrier should be placed on south and west side of the transformer and extended at least 2 meters beyond the transformer such that noise flanking is negligible. Barrier corner coordinates are:

***Two sided barrier's 3 corner points are provided below***

<b>3 corners</b>	<b>Easting [m]</b>	<b>Northing [m]</b>
<b>Corner 1</b>	622832	4754687
<b>Corner 2</b>	622832	4754670
<b>Corner 3</b>	622842	4754671

## **Appendix G Response to Ministry of the Environment Technical Review Comments**

---

*Note: Appendix Provided in September 2014, AAR provided without edits*

G1 – Verification of Specific Noise Receptors

G2 – Supplemental Information to Address MOE Comments

G3 – Sound Power Level Rationale

G4 – Supplemental MOECC Receptor Verification Comments

**Appendix G1 – Verification of Specific Noise Receptors**

During the Ministry of the Environment (MOE) Technical Review process and through correspondence received through the 60-day Environmental Bill of Rights (EBR) comment period for this Project, specific noise receptors were identified as requiring additional rationale to justify their location and / or classification in the noise model. These specific receptors were identified, reviewed and discussed with the MOE.

As appropriate, additional information was provided to the MOE to rationalize each of the noise receptors. Where amendments were required, the noise model and associated mapping was updated accordingly. The responses provided below summarize the result of discussions with the MOE.

The following information provides a summary of the issues raised regarding specific noise receptors identified for this Project and the rationale and resulting actions taken to either support or amend the Noise Assessment Report (NAR). Copies of applicable correspondence with the MOE and others in regards to these items are attached:

**Info Request 3: Eric Gillespie Letters**Concern:

Correspondence received from Mr. Eric Gillespie dated January 28, 2014 (see attached) indicated that at least 2 dwellings have been omitted from the maps in the NAR.

Response:

Stikeman Elliot, on behalf of NRWC, responded on January 31, 2014 (see attached) requesting further information about the location of potential noise receptors suggested to be missing from the Noise Assessment Report. A response was received from Mr. Gillespie dated February 11, 2014 (see attached) stating that at least two houses were omitted from the maps within the northeast portion of the Study Area, although the location of these dwellings was not provided citing a “lack of necessary equipment” and rationale for it being “impossible ... to pinpoint the exact coordinates of these dwellings”.

Further attempts to contact Mr. Gillespie via email (February 12<sup>th</sup> and February 27<sup>th</sup>, 2014) (see attached) by Stikeman Elliot, as well as verbal discussions and phone messages, have not been successful and no further information has been provided as to the location of these omitted dwellings.

In the absence of further information, several supplemental reviews of the existing information were completed by Stantec to confirm the presence of any additional noise receptors within the Study Area.

Areas within the 40 dBA noise contour and the 550 m setback, which were determined to be the most sensitive area, were targeted for more detailed review. Aerial photographs, GIS parcels comparisons and information provided by the area municipalities with respect to new building permits or Planning Act approvals prior to the issuance of the draft site plan in August 2012 were reviewed. The results of this review identified no additional noise receptors within the 40 dBA contour or within 550m of a proposed turbine.

Further, 2 receptors were identified within 1.5 km of the proposed turbines that were not previously identified, including receptor O\_4001 (described below under Info Request 6) and receptor V\_4000, which is located on a vacant property along the west side of Caistor Gainsborough Rd. in the Township of West Lincoln.

The predicted noise level at receptor V\_4000 is 36.5 dBA and the nearest turbine (T08) is located 928 m from this receptor. As discussed below, O\_4001 is located 780 m from the closest turbine (T27) and the noise level at this receptor is 38.7 dBA. Both of these receptors are below the 40.0 dBA threshold and more than 550 m from the nearest turbine, and meet the requirements in accordance with O. Reg. 359/09.

Action:

Two new receptors have been added to the noise model and summarized in the NAR. There are no impacts on the location of the proposed turbines as a result of these new receptors as they comply with the setbacks and noise thresholds established in O. Reg. 359/09.

**Info Request 4: Receptor 1750**

Concern:

Concerns were raised by the landowner that the existing residence on the property was not identified as such in the NAR. The landowner noted that a dwelling exists on the property, which is part of an operational farm, and that the turbine is located closer to the dwelling than what is identified in the NAR.

Response:

Through site investigations, this property was initially identified as a commercial operation and it was determined to be unclear whether the structure in question was used as a residence or as part of the commercial operation. While commercial operations are exempt from assessment, this structure was conservatively identified as a point of reception (POR) and classified as V\_1750 (i.e. “vacant or future, if not currently” considered a receptor) and included in the noise model.

Despite the conflict in naming convention, the POR representing this structure was placed at the exact location of this dwelling. The predicted noise level at this receptor is 39.7 dBA and the nearest turbine (T06) is located at 697 m from the receptor. As such, the minimum REA setback of 550m has been accommodated for this structure and the noise model demonstrates that the sound level was predicted to be less than 40.0 dBA.

See correspondence dated February 12, 2014 (attached).

Action:

Based on the supplemental information provided by the landowner, this receptor label has been amended from V\_1750 to O\_1750 to recognize the existing residential use on the property. There are no impacts to the Project since this receptor complies with the minimum setback and noise threshold requirements under O. Reg. 359/09.



**Info Request 5: Receptor 3582 and 3583**Concern:

Concerns were raised by the landowner with respect to the placement of the receptors on the subject property. The landowner claimed that the existing barn, while not currently a dwelling, could be converted to a residential use and therefore should be recognized as a noise receptor. The landowner also claimed that they intend to build a new house on the subject property at a location different than where receptor V\_3583 is located.

Response:

The subject property consists of two distinct parcels, one of which consists of an agricultural field and the other as a former rail line. Receptor V\_3583 is located on the former rail line parcel, while V\_3582 is identified on the property to the east where the existing barn is located. Both receptors are identified as vacant lot receptors as there are no dwellings constructed, or approved for construction, on the subject property.

The existing barn structure does not meet the definition of a noise receptor under O. Reg. 359/09, based on the size, shape and orientation of the structure and surrounding gravel parking area, construction equipment and outside storage containers. Further, the landowner and Township of West Lincoln have acknowledged that the structure is not currently used as a dwelling. In order to be converted to permit a residential use, the structure would have to be changed to comply with the Building Code and approved through the issuance of a building permit, which has not been completed to date (or prior to the issuance of the draft site plan).

The vacant lot receptor (V\_3582) located on this parcel was located between the barn and the road, consistent with the pattern of the area (i.e. houses are typically located between the road and the barn, not behind) and in line with the existing dwelling to the east, in accordance with the MOE Noise Guidelines. It is also located in proximity to a second access to the property. While the landowner may claim to have future plans for a house elsewhere on the property, there is no rationale for this alternate location over others nor an approved building permit or planning approvals for this work (as confirmed by the landowner).

In the absence of a building permit confirming the location of an approved dwelling prior to issuance of the draft site plan, the location of Receptor 3582 reflects a location where a building would “reasonably” be expected to be located, having regard to the existing zoning by-laws and the typical building pattern of lots in the area, in accordance with the requirements of O. Reg. 359/09 and MOE Noise Guidelines.

Further, the location of Turbine T93 complies with all applicable property line and waterbody setback distances defined under O. Reg. 359/09, as illustrated in the supporting REA technical reports under separate cover. See correspondence dated February 12, 2014 (attached). See correspondence dated February 13, 2014, April 17, 2014, April 23, 2014 and May 9, 2014 (attached).

Action:

No amendments to the NAR or no revision of model are required. Confirmation of the information summarized above and included in the attached correspondence has been requested through a *Freedom of Information Act* request to the Township of West Lincoln. This

request is being process at the time of the preparation of this report, and once available, this will be provided to the MOE.

**Info Request 6: Receptors 735, 794, 1762, 582, 674 and 148**

***V\_735 – Regional Road 65, West Lincoln***

Concern:

Concern was raised that this lot was incorrectly identified as a vacant property.

Response:

During the site investigations, this property was identified as a potential commercial property and it was determined to be unclear whether the structure in question was used as a residence or as part of the commercial operation. While commercial operations are exempt from assessment, this structure was conservatively identified as a point of reception (POR) and classified as V\_735 (i.e. “vacant or future, if not currently” considered a receptor) and included in the noise model.

Despite the conflict in naming convention, the POR representing this structure was placed at the exact location of this dwelling. The predicted noise level at this receptor is 36.9 dBA and the nearest turbine (T54) is located at 920 m from the receptor. As such, the minimum REA setback of 550m has been accommodated for this structure and the noise model demonstrates that the sound level was predicted to be less than 40.0 dBA. See correspondence dated March 6, 2014 (attached).

Action:

Based on the supplemental information provided by the landowner, this receptor label has been amended from V\_735 to O\_735 to recognize the existing residential use on the property. There are no impacts to the Project since this receptor complies with the minimum setback and noise threshold requirements under O. Reg. 359/09.

***V\_794 – Regional Road 65, West Lincoln***

Concern:

Concern was raised that this lot was incorrectly identified as a vacant property.

Response:

Based on our review of the current aerial photography, field verification during the initial development of the noise model to identify POR's, and review of building permits prior to issuance of the draft site plan, this property is a correctly identified as a vacant property. There is no existing dwelling on this property and no dwelling was approved prior to the issuance of the draft site plan. Receptor V\_794 was appropriately located on the subject property within the noise model. See correspondence dated March 6, 2014 (attached).

Action:

No change to the noise model is required.

***V\_1762 – Concession Road 4, West Lincoln***Concern:

Concern was raised that this lot was incorrectly identified as a vacant property.

Response:

The subject property is located at the intersection of 2 unopened road allowances - Concession 4 (running east-west along the south side of the property) and Dengo Road (running north-south along 2 the east side of the property). The property is also entirely comprised of significant woodland and wetland with no open areas. There is no existing dwelling on the subject property. However, a vacant lot receptor was conservatively identified in the noise model for the subject property.

It is possible that questions arising regarding the location of V\_1762 may be in regards to its location relative to a potential dwelling located on the property to the north. While this adjacent property is represented in the noise model by receptor O\_1758, a second structure is visible at the south of the property closer to V\_1762.

Through air photo interpretation, this second structure could be a dwelling; however verification of this structure was not possible through the physical verification process due to property access and isolation of the property. It appears to be accessible only from a private road that extends from Dengo Rd. at the north of the property and is not visible from a municipal right of way.

While not identified in the noise model, this structure was recognized during the development of the project layout and the appropriate receptor setback and noise threshold were maintained. This structure is located 780 m from the closest turbine (T27) and the noise level at this receptor is 38.7 dBA, which is below the 40.0 dBA threshold. See correspondence dated March 6, 2014 (attached).

Action:

No change is required to the location of V\_1762. However, in recognition of the information provided through the EBR and upon further review of the aerial photography, an additional receptor (O\_4001) has been added to the noise model to reflect the location of the apparent dwelling and the NAR has been updated accordingly.

***O\_148 – Concession 4 Road, West Lincoln***Concern:

Concerns were raised as to the proximity of this receptor to the closest proposed turbine, which was suggested to be Turbine T08.

Response:

This receptor is correctly positioned on an existing dwelling that fronts onto Concession 4. Turbine T81 is correctly identified as the closest turbine to receptor O\_148 at a distance of approximately 1,180 m. Turbine T08 is not even the second closest turbine to this receptor, as Turbines T52 and T53 are closer. Turbine T08 is located approximately 2,806 m from receptor O\_148. See correspondence dated March 6, 2014 (attached).

Action:

No change is required to the NAR tables.

***O\_582 and O\_674 – Elcho Road, West Lincoln***

Concern:

Concerns were raised as to the proximity of this receptor to the closest proposed turbine, which was suggested to be Turbine T08.

Response:

The location of receptor O\_582 and O\_674 are correctly positioned on exiting dwellings fronting onto Elcho Rd. The closest turbine to these receptors is confirmed to be Turbine T07, which is located 612 m and 558 m away, respectively. See correspondence dated March 6, 2014 (attached).

Action:

No changes are required to the NAR tables.

**Info Request 7: Alleged Receptor between Receptors 1481 and 1598**

Concern:

Concern was raised that an occupied home between receptors 1481 and 1598 is that is not shown on the maps or included in the NAR reports as a receptor.

Response:

Upon further reviewing the aerial photographs, property mapping and site photographs of the various structures along this stretch of Regional Rd. 20, all parcels between Receptors 1481 and 1598 are represented by a noise receptor and there are no “occupied homes” that have been missed in the noise model.

See correspondence dated March 13, 2014 (attached).

Action:

No changes to the noise model or NAR are required.



**ERIC K. GILLESPIE PROFESSIONAL CORPORATION**  
**BARRISTERS & SOLICITORS**

Eric K. Gillespie, LL.B.  
 Direct Tel: 416.703.6362  
 Email: [egillespie@gillespie-law.ca](mailto:egillespie@gillespie-law.ca)

**FACSIMILE TRANSMISSION**

TO	FIRM	FACSIMILE NO.
President	Niagara Region Wind Corporation	416-314-8452

**From:** ERIC K. GILLESPIE  
**Firm:** ERIC K. GILLESPIE PROFESSIONAL CORPORATION  
**Date:** January 28, 2014  
**Re:** Niagara Region Wind Farm – Unidentified Noise Receptors  
**Our File No.:** 00717

**PAGES (including cover sheet):** 2

If you do not receive all pages, please phone Sarah Qulldon at (416) 703-5400

---

**MESSAGE:** Our letter dated January 28, 2014

---

This material is intended for use only by the individual or entity to whom it is addressed and should not be read by, or delivered to, any other person. This material may contain privileged or confidential information, the disclosure or other use of which by other than the intended recipient may result in the breach of certain laws or the infringement of rights of third parties. If you have received this facsimile in error, please telephone us immediately (collect if necessary) so that we can make arrangements for the return of this facsimile and any confirmation copy which you may receive by mail, at our expense.

10 King Street East, Suite 600, Toronto, Ontario M5C 1C3, Canada  
 TEL: 416.703.5400 | FAX: 416.703.9111



**ERIC K. GILLESPIE PROFESSIONAL CORPORATION  
BARRISTERS & SOLICITORS**

Eric K. Gillespie, LL.B.  
Direct Tel: 416.703.6362  
Email: [egil@giljespie@kijlaw.ca](mailto:egil@giljespie@kijlaw.ca)

January 28, 2014

**By Post**

President  
Niagara Region Wind Corporation  
277 Lakeshore Road East, Suite 211  
Oakville, Ontario  
L6J 6J3

Dear Sir or Madam:

**Re: Niagara Region Wind Farm – Unidentified Noise Receptors  
Our File No. 00717**

We have been retained by individuals concerned with the improper identification of noise receptors in the Niagara Region Wind Farm (the "Project") as required under the Guidelines for Renewable Energy Approval Applications and under Ontario Regulation 359/09. Specifically the maps made publically available for the Project do not include at least two noise receptors that were in existence long prior to the publication of the Notice of Draft Site Plan and as such as considered dwellings for the purposes of the Renewable Energy Approval Application. As a result it is impossible to properly calculate the required noise levels and setback distances for these dwellings and for the Project as a whole.

We look forward to your prompt response to these concerns.

Yours truly,

**ERIC K. GILLESPIE  
PROFESSIONAL CORPORATION**

Eric K. Gillespie  
EKG/ga

cc Sarah Raetsen, Senior Program Support Coordinator, Ministry of the Environment, Fax: 416-314-8452

10 King Street East, Suite 600, Toronto, Ontario M5C 1C3, Canada  
TEL: 416.703.5400 | FAX: 416.703.9111



# STIKEMAN ELLIOTT

Stikeman Elliott LLP Barristers & Solicitors

5300 Commerce Court West, 199 Bay Street, Toronto, Canada M5L 1B9  
Tel: (416) 869-5500 Fax: (416) 947-0866 www.stikeman.com

Direct: (416) 869-5257  
Fax: (416) 947-0866  
E-mail: pduffy@stikeman.com

**BY E-MAIL**  
(egillespie@gillespielaw.ca)

January 31, 2014  
File No.: 130367-1001

Mr. Eric Gillespie  
Eric K. Gillespie Professional Corporation  
Barristers and Solicitors  
10 King Street East, Suite 600  
Toronto, ON M5C 1C3

Dear Sirs/Mesdames:

**Re: Niagara Region Wind Farm - Unidentified Noise Receptors**

We are the solicitors for Niagara Region Wind Corporation ("NRWC") and write with respect to your letter of January 28, 2014. Your letter provides insufficient information for NRWC to address the concerns your clients have raised. Please provide us with further information about the potential noise receptors that you believe qualify as dwellings for the purposes of Regulation 359/09. At a minimum, we require municipal addresses for each of the potential receptors. Any additional information you could provide about the potential receptors (i.e. a description of the dwelling, photographs, etc.) would also be helpful.

We ask that you provide the requested information as soon as possible so that NRWC can respond to these concerns in a timely manner.

Yours truly,



Patrick Duffy

PD/il

c.c.: Jim Harbell, *Stikeman Elliott LLP*  
Sarah Raetsen, *Ministry of Environment, (via fax (416) 314-8452)*

TORONTO

MONTREAL

OTTAWA

CALGARY

VANCOUVER

NEW YORK

LONDON

SYDNEY



**ERIC K. GILLESPIE PROFESSIONAL CORPORATION  
BARRISTERS & SOLICITORS**

Eric K. Gillespie, LL.B.  
Direct Tel: 416.703.6362  
Email: [egillespie@gillespielaw.ca](mailto:egillespie@gillespielaw.ca)

February 11, 2014

**By Facsimile**

Sarah Raetsen  
Senior Program Support Coordinator  
Environmental Approvals Branch, Ministry of the Environment  
2 St. Clair Avenue West, Floor 12 A  
Toronto, Ontario M4V 1L5  
Fax: (416) 314-8452

Dear Ms. Raetsen:

**Re: Niagara Region Wind Farm – Unidentified Noise Receptors  
Our File No. 00717**

Thank you for your letter of January 29, 2014. Our clients are aware of at least two houses located within the block bounded by Regional Road 69 to the north, Regional Road 24/Victoria Avenue to the east, and Regional Road 20 to the west and south in the West Lincoln area that have been omitted from the maps made publicly available and, presumably, submitted to the Ministry as part of Niagara Region Wind Corporation's Renewable Energy Approval application package. These dwellings were in existence for a number of years prior to the beginning of this project and, as a result, there does not appear to be any reason why they should have been omitted from the maps. Not having the necessary equipment, it is impossible for our clients to pinpoint the exact coordinates of these dwellings. However, we look forward to hearing from you regarding Niagara Region Wind Corporation's response to these omissions and the results of their review of the project's receptor location maps.

Yours truly,

**ERIC K. GILLESPIE  
PROFESSIONAL CORPORATION**

Eric K. Gillespie  
EKG/ga

## Powell, Chris

---

**From:** Patrick Duffy <PDuffy@stikeman.com>  
**Sent:** Thursday, February 27, 2014 12:39 PM  
**To:** 'egillespie@gillespielaw.ca'  
**Cc:** Jim Harbell  
**Subject:** RE: NRWC re Unidentified Noise Receptors  
**Attachments:** NRWC - Letter to Gillespie re Unidentified Noise Receptors (Dated Jan 31,....pdf)

Eric – Further to my emails below, please get back to us as soon as possible with details of the potential noise receptors referenced in your letter of January 28.

**Patrick Duffy**  
Tel : (416) 869-5257  
[pduffy@stikeman.com](mailto:pduffy@stikeman.com)

---

**From:** Patrick Duffy  
**Sent:** Wednesday, February 12, 2014 12:38 PM  
**To:** 'egillespie@gillespielaw.ca'  
**Cc:** Jim Harbell  
**Subject:** RE: NRWC re Unidentified Noise Receptors

Eric - I appreciate you have a few other things going on this week, but can you get back to us on the attached letter as soon as possible. If there is someone else in our office we should be dealing with on this matter, just let me know. Thanks.

**Patrick Duffy**  
Tel : (416) 869-5257  
[pduffy@stikeman.com](mailto:pduffy@stikeman.com)

---

**From:** Ivy C Lee **On Behalf Of** Patrick Duffy  
**Sent:** Friday, January 31, 2014 2:57 PM  
**To:** 'egillespie@gillespielaw.ca'  
**Cc:** Jim Harbell; Patrick Duffy  
**Subject:** NRWC re Unidentified Noise Receptors

Dear Mr. Gillespie,

Please see attached.

Regards,  
Ivy

**Ivy Lee**  
Legal Administrative Assistant to Patrick Duffy  
Tel : (416) 869-5569  
[ilee@stikeman.com](mailto:ilee@stikeman.com)

## Powell, Chris

---

**From:** Powell, Chris  
**Sent:** Thursday, March 06, 2014 1:45 PM  
**To:** Miller, Denton (ENE)  
**Cc:** Raetsen, Sarah (ENE); Darren Croghan; Leggett, Al; Patrick Duffy  
**Subject:** RE: NWCF Info Request - 3b MOE ref file # 1175-972NB9

Denton,

To my knowledge, there has been no response to the letter sent to Mr. Gillespie's office regarding this issue dated January 31, 2014. However, I will follow-up with NRWC to confirm if any further contact has been made with / received from Mr. Gillespie's office and will advise you as soon as possible with an update.

Sincerely,

Chris

**Chris Powell, M.A.**  
Project Manager, Environmental Planner  
Associate, Environmental Services  
Stantec Consulting Ltd.

Office: (519) 585-7416  
Cell: (519) 501-2368  
[chris.powell@stantec.com](mailto:chris.powell@stantec.com)

---

**From:** Miller, Denton (ENE) [Denton.Miller@ontario.ca]  
**Sent:** March 6, 2014 12:58 PM  
**To:** Powell, Chris  
**Cc:** Raetsen, Sarah (ENE)  
**Subject:** RE: NWCF Info Request - 3b MOE ref file # 1175-972NB9

Hello Chris

Did you receive a response from Eric Gillespie re our Jan 30, 2014 e-mail info request 3 to your office ?

Attached is a letter that EAB received from Eric Gillespie addressing the same issue .

*Regards*  
*Denton Miller*  
*416-314-8310*

---

**From:** Powell, Chris [<mailto:Chris.Powell@stantec.com>]  
**Sent:** January 31, 2014 3:39 PM  
**To:** Raetsen, Sarah (ENE); Miller, Denton (ENE)  
**Cc:** Leggett, Al; 'mervcroghan@nrwc.ca'; 'darrenc@nrwc.ca'; 'sberriman@nrwc.ca'; 'pduffy@stikeman.com'; 'JHarbell@stikeman.com'  
**Subject:** Fw: Niagara Region Wind Farm Information request - 3 MOE ref file # 1175-972NB9

Sarah / Denton,

In regards to the letter from Mr. Gillespie, NRWC has followed up with his firm to seek clarification on the location of the referenced noise receptors (see attached).

We will keep you informed of any response and once confirmed, will advise of the outcome.

Chris

Chris Powell, M.A.  
Project Manager  
Environmental Planner  
Stantec  
Cell: (519) 501-2368

Sent from my Blackberry

---

**From:** Patrick Duffy [<mailto:PDuffy@stikeman.com>]  
**Sent:** Friday, January 31, 2014 02:56 PM  
**To:** 'egillespie@gillespielaw.ca' <[egillespie@gillespielaw.ca](mailto:egillespie@gillespielaw.ca)>  
**Cc:** Jim Harbell <[JHarbell@stikeman.com](mailto:JHarbell@stikeman.com)>; Patrick Duffy <[PDuffy@stikeman.com](mailto:PDuffy@stikeman.com)>  
**Subject:** NRWC re Unidentified Noise Receptors

Dear Mr. Gillespie,

Please see attached.

Regards,  
Ivy

**Ivy Lee**  
Legal Administrative Assistant to Patrick Duffy  
Tel : (416) 869-5569  
[ilee@stikeman.com](mailto:ilee@stikeman.com)

**STIKEMAN ELLIOTT LLP** Barristers & Solicitors  
5300 Commerce Court West, 199 Bay Street, Toronto, ON, Canada M5L 1B9  
[www.stikeman.com](http://www.stikeman.com)

---

TORONTO MONTREAL OTTAWA CALGARY VANCOUVER NEW YORK LONDON SYDNEY

---

This e-mail is confidential and may contain privileged information. If you are not an intended recipient, please delete this e-mail and notify us immediately. Any unauthorized use or disclosure is prohibited.

## **Appendix G2 – Supplemental Information to Address MOE Comments**

During the Ministry of the Environment (MOE) Technical Review process and through correspondence received through the 60-day Environmental Bill of Rights (EBR) comment period for this Project, additional information was requested by the MOE to complete their technical review of the NAR.

The following information provides a summary of the additional information requested by the MOE for this Project and the corresponding response from the project team. Copies of applicable correspondence with the MOE and others in regards to these items are attached:

### **Munich Higher Regional Court's Decision**

Concern:

MOE requested comments from Enercon on the following court decision identified via an EBR comment:

The Munich Higher Regional Court's decision pertinent to impulsive sound from Enercon E-82 wind turbines in a wind farm located in Rennertshofen in the district of Neuburg-Schrobenhausen. Judgment OLG München 14.08.2012

Response:

The following comments were provided by Enercon, the manufacturer of the E-82 turbine, in response to MOE's request for information on this issue:

The article referenced is in regard to a claim and subsequent ruling which has been made against Enercon regarding the impulsivity of E-82 turbines in one of its wind parks near Munich, Germany. Enercon is in full disagreement with the ruling and are launching a full appeal against the region.

In response, as per the official comments from Enercon GmbH made on this issue:  
"for us, this ruling is completely incomprehensible", says Felix Rehwald, Spokesperson for Europe's largest wind turbine manufacturer Enercon.

He continues to comment that Enercon manufactures, sells and guarantees its turbines worldwide against tonality (in accordance with the IEC standards) and furthermore that Enercon's own specialists in sound power have yet to yield any measurements which would indicate impulsivity of the turbines and as such, Enercon is launching counter-proceedings in the way of an appeal against the ruling.

The court case in Germany is not related to the NRWC project from a technical and environmental permitting perspective. See correspondence dated April 16, 2014 (attached).



Action:

The noise model has been completed in accordance with the sound power level information provided by Enercon, as supported by Kotter. No adjustments are required.

**Rosa Flora Turbine**

Concern:

The source data for the Rosa Flora turbine described in the NAR and as identified in the supporting Cadna files provided to the MOE reference different sound power levels for this existing turbine.

Response:

The Rosa Flora turbine is a 0.65 MW (650 kW) turbine located approximately 3,500 m from the nearest NRWC turbine. The maximum sound power level for this turbine as used in the noise model is 103.5 dBA, as noted in Section 3.3 (page 3.9). This is further confirmed in the sample calculation and Cadna/A input/outputs table provided in Appendix E of the NAR and in the adjusted emission level for the Rosa Flora turbine identified in Table F1 of Appendix F of the NAR. This value was rounded to 104 dBA in Table 3.8 of the NAR.

Further, the version of the Cadna file that was provided to the MOE as part of the technical review process consisted a lower number. The correct version of this file representing the 103.5 dBA sound pressure level, as used in the noise model for this Project, was provided to the MOE. See correspondence dated April 16, 2014 (attached).

Action:

To avoid confusion, Table 3.8 has been amended to illustrate a maximum sound power level of 103.5 dBA, as used in the noise model for this individual turbine. No changes to the tables in Appendix C, E or F of the NAR are required.

## Powell, Chris

---

**From:** Miller, Denton (ENE) <Denton.Miller@ontario.ca>  
**Sent:** Thursday, February 13, 2014 10:40 AM  
**To:** Powell, Chris  
**Cc:** Raetsen, Sarah (ENE)  
**Subject:** RE: NRW Information request - 4 MOE ref file # 1175-972NB9

Hello Chris

We are satisfied with your explanation.

NRWC will be required to update the current noise study (or submit an amendment) addressing the noted oversights in the September 2013 noise study.

Regards

DM

---

**From:** Powell, Chris [<mailto:Chris.Powell@stantec.com>]  
**Sent:** February 10, 2014 2:57 PM  
**To:** Miller, Denton (ENE)  
**Cc:** Raetsen, Sarah (ENE); Ganesh, Kana; Leggett, Al; Darren Croghan; Merv Croghan; Shiloh Berriman ([sberriman@nrwc.ca](mailto:sberriman@nrwc.ca))  
**Subject:** RE: NRW Information request - 4 MOE ref file # 1175-972NB9

Denton,

We have looked into this request and offer the following rationale for the identification of this receptor as identified in the Noise Assessment Report:

During the initial development of the noise model, and identification of receptors (POR's), our field crews reviewed each of the potential POR's to confirm and verify the appropriate classification of these structures. Based on their site investigations, our field crew identified this particular property as "potentially commercial" due to several exhaust fans and dust collector style structures within the property. The following are two photographs of the subject property, with Receptor 1750 visible in both photos (behind trees in photo 1, more visible in photo 2):

Photo 1:



Photo 2:



The guidelines for wind farms suggest the following:

*For the purpose of approval of new sources, including verifying compliance with section 9 of the Environmental Protection Act, the Point of Reception may be located on any of the following existing or zoned for future use premises: permanent or seasonal residences, hotels/motels, nursing/retirement homes, rental residences,*

hospitals, camp grounds, and noise sensitive buildings such as schools and places of worship. A point of receptor is defined as a sensitive land use.

Typically, commercial properties are exempted from assessment, however, it was not possible to verify whether this structure was in fact commercial or supporting a residential use. Therefore, we conservatively identified this structure as a receptor (1750). Our initial thought was to identify this structure as "Other", but later decided to have a "V\_" suffix applied to this structure to mean "vacant or future, if not currently" considered a receptor.

Despite the conflict in naming convention, the POR representing this structure was placed at the exact location as the current location of this house. The predicted noise level at this POR is 39.7 dBA and the nearest turbine (T06) is located at 697 m from the receptor. As such, the minimum REA setback of 550m has been accommodated for this structure and the model demonstrates that the sound level was predicted to be less than 40.0 dBA

We trust that this clarifies the question from the public and for your consideration during the technical review process.

If you have any further questions, please do not hesitate to ask.

Sincerely,

Chris

---

**From:** Miller, Denton (ENE) [<mailto:Denton.Miller@ontario.ca>]  
**Sent:** Monday, February 03, 2014 11:02 AM  
**To:** Powell, Chris  
**Cc:** Raetsen, Sarah (ENE)  
**Subject:** RE: NRW Information request - 4 MOE ref file # 1175-972NB9

Hi Chris

We have been approached by the owner of the lot that contains V\_1750 ( re: your Sept 30 , 2013 noise report). He has made the following assertion:

I am the OPERATIONAL FARM that has been in business since 1958 and I am marked as VACANT and the turbine is much closer than what NRWC has submitted.

The following is additional information about V\_1750 as noted in the Sept 30 , 2013 noise report .

Receiver ID	Night (dBA)	Height (m)	Coordinates		
			X (m)	Y (m)	Z (m)
V_1750	39.7	4.5	623,336.69	4,766,590.11	189.5

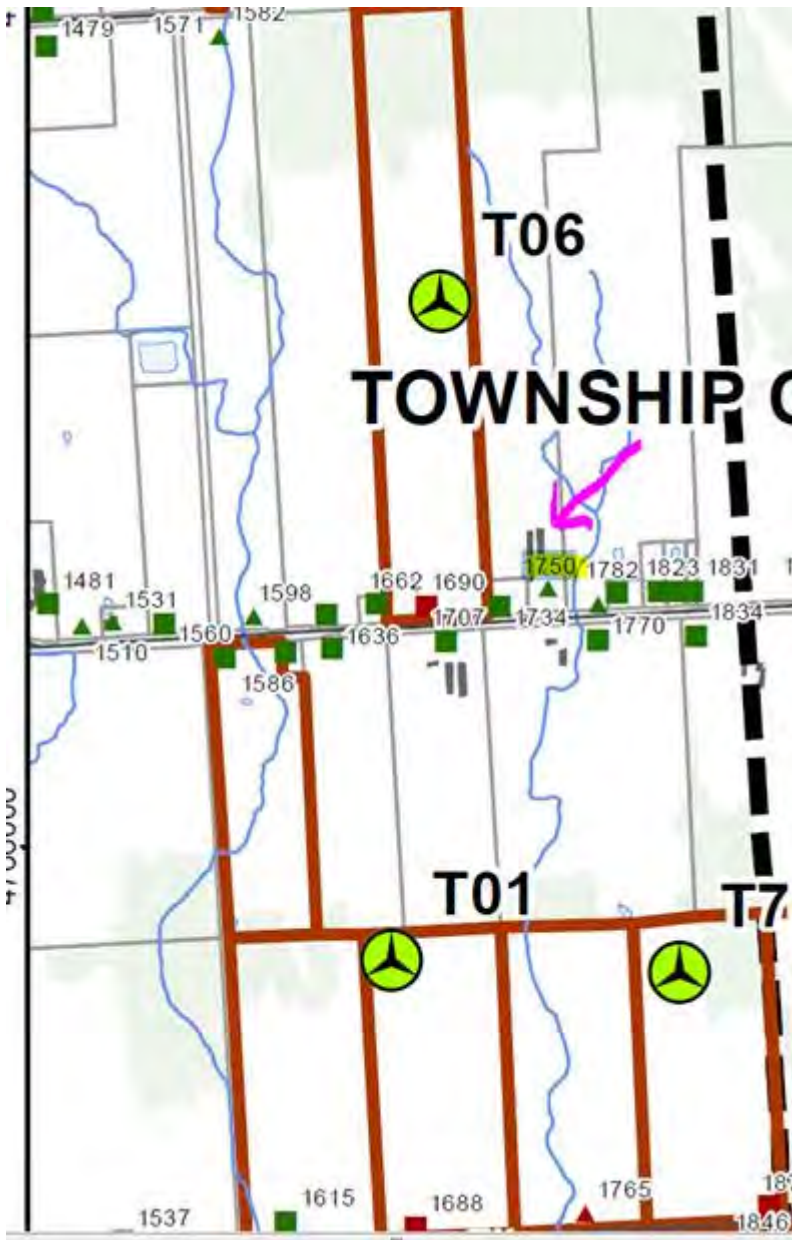

Please provide rationale why this receptor was deemed to be a vacant lot.

*Regards*  
*Denton Miller*  
*416-314-8310*

## Powell, Chris

---

**From:** Powell, Chris  
**Sent:** Thursday, February 13, 2014 2:16 PM  
**To:** 'Miller, Denton (ENE)'  
**Cc:** Raetsen, Sarah (ENE); Leggett, Al; Darren Croghan  
**Subject:** RE: NRWC info request -5 Letter dated Jan 22, 2014 Receptor 3583  
**Attachments:** Attachment 1 - Subject Properties.jpg; Attachment 2 - Aerial of Barn Building.jpg; Attachment 3 - BarnBldgNearT93.jpg

Denton,

The property on which receptor V\_3583 is located is a former rail line, which extends from Concession 4 to Silver Street. This property is a separate parcel from the one immediately to the east where the barn is located (see Attachment 1). These properties may be under common ownership, however remain as two distinct parcels. As such, we have identified two distinct receptors on these parcels (V\_3583 and V\_3582), both fronting onto Concession 4. V\_3583 is located on the former rail line parcel, while V\_3582 is identified on the property to the east where the barn is located.

For the purpose of approval of new sources, including verifying compliance with section 9 of the Environmental Protection Act, the Point of Reception may be located on any of the following existing or zoned for future use premises:

- permanent or seasonal residences;
- hotels/motels;
- nursing/retirement homes;
- rental residences;
- hospitals;
- camp grounds; and
- noise sensitive buildings such as schools and places of worship.

The existing barn does not satisfy any of these criteria.

This barn was reviewed by our field staff when verifying the presence and location of Points of Reception for this project. During their surveys, the following observations were made specific to the barn:

1. The size of the building is larger than a 'typical house' (see Attachment 2 - aerial imagery);
2. The shape of the building resembles that of a barn and not of a dwelling (see Attachment 3 – building photograph);
3. The orientation of the building was perpendicular to Concession 4, while houses typically (but not always) face the road; and
4. The building is also surrounded on all sides by gravel, construction equipment and outside storage containers, which are atypical of a residential use (see Attachment 3 – building photograph).

Based on these observations, we concluded this building could be a barn or a similar structure and does not meet the criteria for a residential dwelling.

Correspondence received from this landowner between September 2012 and February 2013, after issuance of the draft site plan, confirmed that there was no dwelling on the property but they intended to build a dwelling on the property in the future. As part of our due diligence in preparing the draft site plan, we consulted in advance with the Township to confirm whether any building permits had been issued for this property, and others in the Project study area. It was confirmed that no building permit was issued by the Township of West Lincoln for a residence or residential use on the subject property prior to the issuance of the draft site plan in August 2012.



The future potential conversion of a barn is not considered as a residential use or structure, and this barn structure did not contain an existing residential use at the time the draft site plan was issued. As noted by this landowner in the information attached to your email, "there is no dwelling on the property", and while the Township has informed this landowner that the upper floor could be converted to a residential use, it would require "changes ... to comply with the building code".

Vacant Lots are defined as receptors that have been zoned by the local municipality to permit residential or similar noise-sensitive uses. The receptor location, if unknown at the time of the proposal (i.e. no building permit issued for construction), shall be based on a 1 hectare (10,000 m<sup>2</sup>) building envelope within the vacant lot property that would reasonably be expected to contain the use, and that conforms with the municipal zoning by-laws in effect. The specific receptor location for assessment purposes should be assumed to be 4.5 m above grade and:

1. consistent with the typical building pattern in the area, or
2. at the centre of the 1 hectare building envelope.

Since there is a barn on the property (and no existing receiver), vacant lot receptor V\_3582 is located between the barn and the road consistent with the pattern of the area, and in line with the existing dwelling to the east. It is not typical to have receivers behind a barn in the entire study area.

Therefore, while this landowner may not agree with the location of the vacant lot receptor on the subject property, it has been identified and appropriately located in accordance with the requirements of O. Reg. 359/09.

We trust that this supports the Noise Assessment Report and clarifies any questions you may have in this regard. If you have any further questions, please do not hesitate to ask.

Sincerely,

Chris

**Chris Powell, M.A.**

Project Manager, Environmental Planner  
Stantec  
49 Frederick Street Kitchener ON N2H 6M7  
Phone: (519) 585-7416  
Cell: (519) 501-2368  
Fax: (519) 579-6733  
Chris.Powell@stantec.com



The content of this email is the confidential property of Stantec and should not be copied, modified, retransmitted, or used for any purpose except with Stantec's written authorization. If you are not the intended recipient, please delete all copies and notify us immediately.

 Please consider the environment before printing this email.

---

**From:** Miller, Denton (ENE) [mailto:Denton.Miller@ontario.ca]  
**Sent:** Thursday, February 13, 2014 8:28 AM  
**To:** Powell, Chris  
**Cc:** Raetsen, Sarah (ENE); Leggett, Al; Darren Croghan  
**Subject:** RE: NRWC info request -5 Letter dated Jan 22, 2014 Receptor 3583

Hello Chris

Further to my previous E-mail ( info request -5) of Wednesday, February 12, 2014 1:57 PM , please also consider the following set back distance issues noted in the following excerpt from an e-mail I received yesterday from the owner of the lot identified with the vacant lot receptor ID 3583.

Thank You

Regards  
Denton Miller  
416-314-8310

---

**From:** XXXXX  
**Sent:** February 12, 2014 8:28 PM  
**To:** Miller, Denton (ENE)  
**Subject:** Re: FW: Re: Letter dated Jan 22, 2014 XXXXXXXX

Hello Mr. Miller

My property is the one with the number 3583 under the green triangle, immediately west of the property where T 93 is proposed. The western property line (the gray diagonal line) is a former railroad right-of-way. Our property is 32.61 acres, zoned A 2 agricultural, with provision for one private residence. I do not know what the green triangle on the right-of-way represents. Does it refer to our barn? The barn is 66 meters (216 feet) from the front property line and 23 meters (75 feet) from the west side property line.

XXXXXXXXXX

The green square 542, is a privately owned natural gas pumping station that is not currently pumping. XXXXXXXXXX

T93 is less than **70 meters** from the property line and approximately **440 meters** (1445 feet) from the site of our proposed house. The future house location was set in 2005 and all the infrastructure on the property was built to suit our choice of house site. There is a raised filter bed for the septic system for the barn which is fully plumbed and drained. The building has natural gas which supplies the boiler for the in-floor radiant heating and the furnace to heat the upper floor.

Due to the [septic bed location and the gas line location](#), it is impossible to build a house where NRWC says we should build it. There is a driveway, installed in 2005, that is 50 feet from the property line. Do I build the house on the driveway? How do I get to the barn? As you can see, not one clear thinking person has even physically looked at our property.

Putting a rural home 15 meters from a gravel road is absurd for a family that is trying to escape the noise and congestion of Mississauga. Not one home built in the last few years in West Lincoln on a property one acre or more, has been built 15 m (50 ft) from the road.

Between the two driveways, there are berms installed that slope away from the roadway to allow for drainage for the fruit and nut trees we intend to plant there. The slope drains into a swale that empties into the watercourse that runs along the eastern side of the property.

If you view aerial photos of the property, you can clearly see how we have prepared the property to accommodate a house that will **be at least 320 feet from the road**.

I have provided all this information to show that the building of the house was to be the culmination of a well thought out plan that predates the Green Energy Act., the Niagara Region Wind Corporation and this industrial Wind Turbine Proposal.

Our plan allowed for a sustainable and enhanced use of this property to keep employing the land for agricultural purposes while also having an energy efficient residence.

If there are any further questions or if you need more information, do not hesitate to contact me.

With Thanks

XXXXXXXXXX

*Regards*  
*Denton Miller*  
*416-314-8310*

---

**From:** Powell, Chris [<mailto:Chris.Powell@stantec.com>]  
**Sent:** February 12, 2014 2:51 PM  
**To:** Miller, Denton (ENE)  
**Cc:** Raetsen, Sarah (ENE); Leggett, Al; Darren Croghan  
**Subject:** RE: NRWC info request -5 Letter dated Jan 22, 2014 Receptor 3583

Denton,

We are familiar with these two properties and consulted with this landowner during the REA process. We will prepare a response to this comment and send it to you shortly.

Chris

---

**From:** Miller, Denton (ENE) [<mailto:Denton.Miller@ontario.ca>]  
**Sent:** Wednesday, February 12, 2014 1:57 PM  
**To:** Powell, Chris  
**Cc:** Raetsen, Sarah (ENE)  
**Subject:** NRWC info request -5 Letter dated Jan 22, 2014 Receptor 3583

Hello Chris

We have been approached by the owner of the lot that contains vacant lot receptor 3583 ( re: your Sept 30 , 2013 noise report; see diagram below). He has made the following assertion:

There is currently no dwelling on the property , although there is a new barn. The Township of West Lincoln now says can have the upper floor used as a dwelling, provided that changes are made to comply with the building code. The center of the existing building, erected in 2007 is 513 meters from the proposed turbine {T 93}. This building was built by us long before there was an NRWC.

All of the infrastructure on this property was placed there by us after taking possession on January 15, 2004.

Please refer to the attached document for a detailed description of all the noise issues identified by the owner of the lot and provide EAB with a response.

Your response should also address the definition of dwelling as defined Ontario Regulation 359/09 and how it applies to the existing barn on the subject property.

Thank You

DM



**Denton Miller** | Senior Review Engineer | Team 5 | Environmental Approvals Branch | Ministry of the Environment  
2 St. Clair Ave W. 12a Floor Toronto, Ontario, M4V 1L5 | Phone: 416-314-8310 | [Denton.Miller@ontario.ca](mailto:Denton.Miller@ontario.ca)



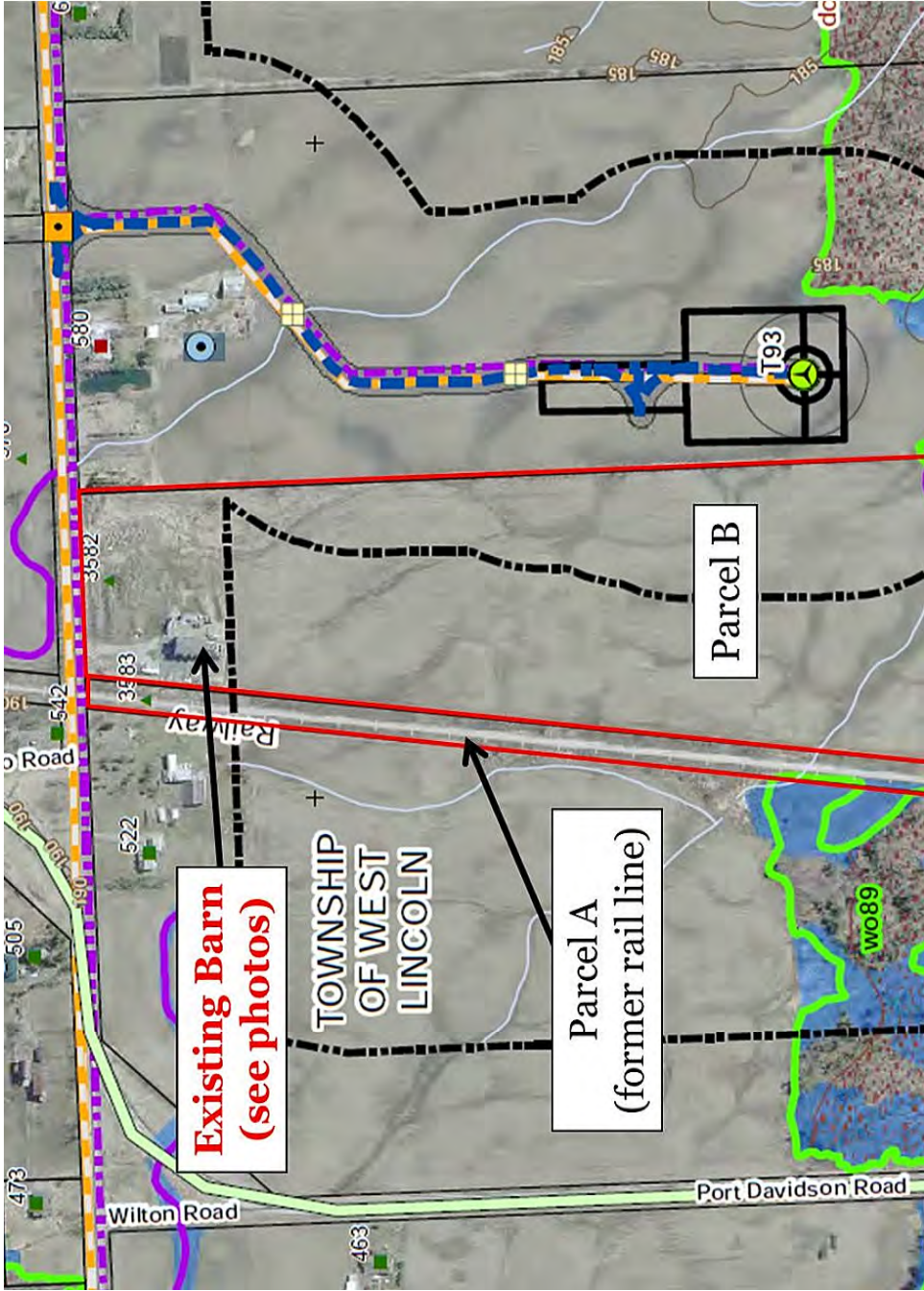





Google earth

© 2012 Google

Image © 2013 GeoEye





## Powell, Chris

---

**From:** Powell, Chris  
**Sent:** Thursday, April 17, 2014 4:43 PM  
**To:** Denton.Miller@ontario.ca; Raetsen, Sarah (ENE)  
**Cc:** Darren Croghan; Merv Croghan; Shiloh Berriman (sberriman@nrwc.ca); Leggett, Al (Al.Leggett@stantec.com); Ganesh, Kana  
**Subject:** FW: Building Permit in West Lincoln - (RE: NRWC info request -5 Letter dated Jan 22, 2014 Receptor 3583)  
**Attachments:** let\_FOI\_for\_6374\_Conc\_4\_West\_Lincoln\_2014\_03\_20.pdf; 2 - Twp - FOI Update\_04apr14.pdf; 3 - Janzen Google Streetview - June 2012.pdf; 4 - MOE - 5a - Receptor 3583\_12feb14.pdf  
**Importance:** High

Denton / Barbara,

Further to our call on April 9, 2014, the purpose of this email is to follow up on the status of our Freedom of Information Act (FOI) and to provide additional information with respect to the setbacks and receptor location identified for the subject property. Previous responses to this string of emails were provided to the MOE on February 13, March 20 and March 27, 2014 and should be read in conjunction with the following information.

### Freedom of Information Act Request

A copy of the Freedom of Information Act (FOI) request sent to the Township on March 25, 2014 is attached. Also attached is the response we received from the Township of West Lincoln with respect to our FOI request for the building permit for 6374 Concession Road 4, West Lincoln (i.e. property west of T93). This response indicates that they may not be able to respond to our request within the timeframe allotted by the MOE, and beyond that will be subject to potential further delays awaiting confirmation from the landowner who will be provided the opportunity to object to the release of the requested information in accordance with the Freedom of Information Act. To date, we have not received the requested information from the Township in this regard.

As soon as a copy of the building permit information is available, we will forward it to your attention. However, based on the FOI process currently underway with the Township, it may not be possible to provide the MOE with a copy of the building permit by the requested deadline of April 17, 2014.

### Existing Barn Structure

Stantec, on behalf of NRWC, has undertaken to clarify that the existing structure on the subject property is not a dwelling, and was not a dwelling at the time of crystallization (August 2012). We have incorporated observations of current site conditions into the identification of noise receptors, have corresponded with the landowner during the REA consultation process, and have discussed this specific property with Township staff. We have also provided supporting information to the MOE during the review for completeness and further during the technical review process, all of which suggests that the existing structure is not a dwelling, including comments received from the landowner (per your email dated February 12, 2014) confirming that "there is currently no dwelling on the property, although there is a new barn" (see attached).

While we currently do not have a copy of the building permit issued for the construction of the barn, we have requested this information from the Township and will continue to follow up with them to obtain this information. We have discussed this issue on several occasions with Brian Treble from the Township of West Lincoln who has verbally confirmed that the existing structure is not permitted for a residential use and would be subject to further building permits and approvals in order to convert this structure to permit a residential use.

No evidence has been presented by the landowner confirming that the existing barn structure is in fact a dwelling, and by identifying a desire to construct a dwelling elsewhere on the property suggests his intent is not to use the existing structure as a dwelling. While their long term plans may be to establish a residential structure on the subject property, either utilizing the existing structure or constructing a new dwelling on the property, to our knowledge no building permits have been issued permitting a residential structure on the subject property, or permitting use of the existing structure as a dwelling. This will be confirmed through the Township of West Lincoln FOI request.

### **Location of Receptor 3583**

*For the purposes of defining the location of a noise receptor on vacant land, the applicant must specify the position on the lot where a building would reasonably be expected to be located, having regard to the existing zoning by-laws and the typical building pattern of lots in the area (MOE, 2012).* Rationale for the location of Receptor 3583 was discussed in our email dated February 13, 2014.

Further to that email, questions have been raised as to the existence of a second driveway entrance to the property and its influence on determining the location of a vacant lot receptor on the subject property. We acknowledge that a secondary entrance to the property existed at the time the draft site plan was issued, as illustrated in the attached photograph (dated June 2012), however there is no evidence that a gravel driveway existed prior to the issuance of the draft site plan for this Project (August 2012). The location of Receptor 3583 is in proximity to this secondary entrance, which could accommodate a proposed future dwelling subject to the issuance of Building Permit.

While there is evidence of grading on the subject property, as visible in the available aerial photography, there is no obvious building location evident based on the information available. While the landowner may have future plans for a house on the property to be located 320 feet (97.5m) from the front of the property, there is no rationale for this location over others nor approved building permits (as confirmed by the landowner) that would support this location.

Furthermore, we suggest that the existence of Turbine T93 would not preclude the landowner from building a house at this location at some point in the future. While minimum setbacks apply for turbines being proposed in proximity to existing and/or approved dwellings, similar setbacks do not apply for proposed dwellings in proximity to existing and/or approved turbine locations. As such, the location of T93 would not preclude construction of a house on the subject property.

The test of an applicant for determining what is "reasonable" in terms of the location of a vacant lot receptor is not based on the future plans of a landowner but rather documentation approved by a municipality to justify the proposed location, such as an approved Building Permit, Site Plan or Planning Act approval. Taking into account all existing property entrances, driveways or farm access lanes when siting vacant lot receptors would be unreasonable.

In the absence of a building permit confirming the location of an approved dwelling prior to issuance of the draft site plan, the location of Receptor 3583 reflects a location where a building would reasonably be expected to be located, having regard to the existing zoning by-laws and the typical building pattern of lots in the area.

### **Summary**

We trust that this update will address your concerns in regards to Receptor 3583 pending resolution of the FOI request currently in front of the Township of West Lincoln.

Please do not hesitate to give me a call on my cell phone if you have any questions or would like to discuss this further.

Sincerely,

Chris

**Chris Powell, M.A.**

Project Manager, Environmental Planner  
Stantec  
49 Frederick Street Kitchener ON N2H 6M7  
Phone: (519) 585-7416  
Cell: (519) 501-2368  
Fax: (519) 579-6733  
Chris.Powell@stantec.com



The content of this email is the confidential property of Stantec and should not be copied, modified, retransmitted, or used for any purpose except with Stantec's written authorization. If you are not the intended recipient, please delete all copies and notify us immediately.

 Please consider the environment before printing this email.

---

**From:** Miller, Denton (ENE) [<mailto:Denton.Miller@ontario.ca>]  
**Sent:** Thursday, April 03, 2014 3:12 PM  
**To:** Slattery, Barbara (ENE); Kossowski, Julia  
**Cc:** Powell, Chris; Raetsen, Sarah (ENE)  
**Subject:** RE: Building Permit in West Lincoln,

Hi Julia

Could you please provide this information by April 17, 2014.

Thank you

*Regards*  
*Denton Miller*  
*416-314-8310*

---

**From:** Slattery, Barbara (ENE)  
**Sent:** April 3, 2014 3:04 PM  
**To:** Kossowski, Julia ([Julia.Kossowski@stantec.com](mailto:Julia.Kossowski@stantec.com))  
**Cc:** [Chris.Powell@stantec.com](mailto:Chris.Powell@stantec.com); Miller, Denton (ENE)  
**Subject:** Building Permit in West Lincoln,  
**Importance:** High

Julia, I was wondering whether you have obtained a copy of the building and septic system permits for the property in question in West Lincoln to enable the completion of our review of the circumstances for Receptor 3583?



49 Frederick St.  
Kitchener, ON  
N2H 6M7

March 24, 2014  
File: 160950269

**Attention: Ms. Carolyn Langley, Clerk**  
Township of West Lincoln, Clerk's Department  
318 Canborough St, PO Box 400  
Smithville, ON  
LOR 2A0

Dear Ms. Langley,

**Reference: Freedom of Information Request –Approvals re: 6374 Concession Road 4**

On behalf of the Niagara Region Wind Corporation, I would like to submit this request for access to records under the Freedom of Information and Protection of Privacy Act. Specifically, I would like to request a copy of any land use approvals, building permits, building permit applications and supporting documentation relating to existing and/or proposed structures or land uses on the property located at 6374 Concession Road 4, in the Township of West Lincoln.

More specifically, we are requesting any and all building permits, building permit applications and supporting documentation for the following:

- Existing barn, believed to have been issued in 2006 (or after 2004). Specifically, any documentation that confirms the intended and/or approved use of the existing structure;
- Renewal of the 2006 building permit, believed to have been issued in 2007 (or after 2004);
- Any existing / proposed septic beds, including size, date of approval, construction date, etc.;
- Any entrance driveway, including size, date of approval, construction date, etc.; and
- Any other structures or land uses relating to the subject property since 2004.

A figure illustrating the location of the subject property is attached.

Please find enclosed a personal cheque for \$5 for the cost of this request. The documentation would be preferred to be received via email, if possible, or alternatively by regular mail. Please contact me at the number below if you require further information.

Regards,

**Stantec Consulting Ltd.**

Julia Kossowski, P.Eng.  
Project Manager - Power  
Phone: 519 569 4338  
Julia.kossowski@stantec.com

c. Darren Croghan, NRWC, Chris Powell, Stantec

jk m:\01609\active\160950269\planning\correspondence\municipalities\west lincoln\let\_foi\_for\_6374\_conc\_4\_west\_lincoln\_2014\_03\_20.docx



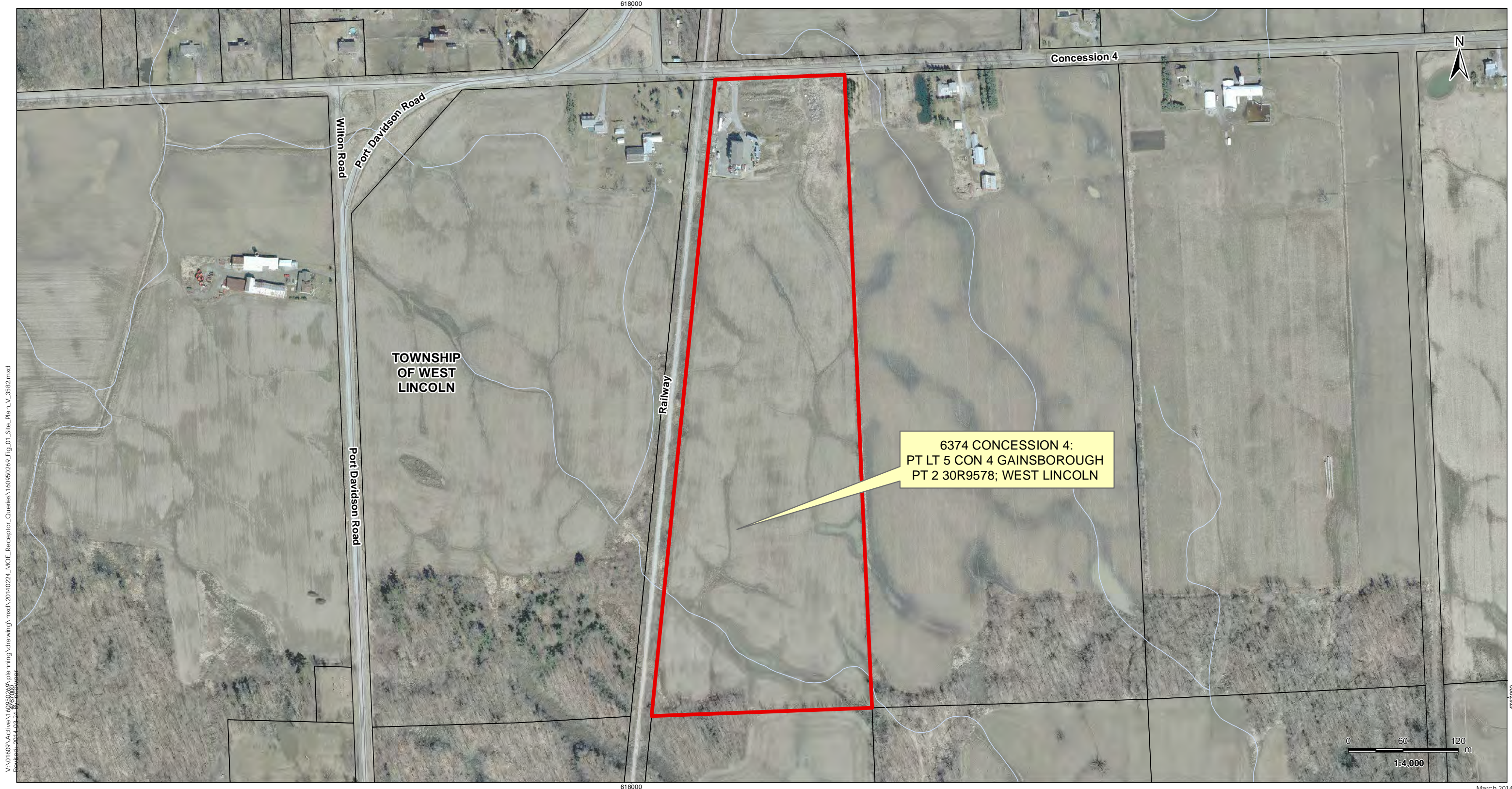

V:\01609\Active\160950269\Planning\Drawing\mxd\20140224\_MOE\_Receptor\_Queries\160950269\_Fig\_01\_Site\_Plan\_V\_3582.mxd  
Revised: 2014.03.04 by [unreadable]

4767000

March 2014  
160950269



- Legend**
- Property Boundary
  - Existing Features**
  - Road
  - Abandoned Railway
  - Watercourse (MNR)
  - Property Boundary

- Notes**
1. Coordinate System: NAD 1983 UTM Zone 17N
  2. Base features produced under license with the Ontario Ministry of Natural Resources © Queen's Printer for Ontario, 2013.
  3. Orthomagery © First Base Solutions, 2010.

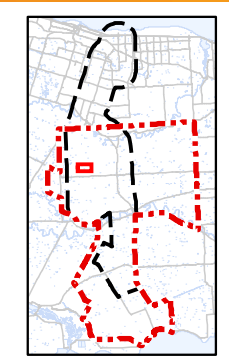

Client/Project  
Niagara Region Wind Corporation

1 PRELIMINARY

6374 Concession 4



## Powell, Chris

---

**From:** Kossowski, Julia  
**Sent:** Friday, April 04, 2014 5:31 PM  
**To:** Powell, Chris; Leggett, Al  
**Subject:** Fw: FOI Request for building permit information

Chris. See email below. Please forward to Darren and MOE if you feel it necessary.

Julia

---

**From:** Carolyn Langley [<mailto:clangley@westlincoln.ca>]  
**Sent:** Friday, April 04, 2014 03:16 PM Mountain Standard Time  
**To:** Kossowski, Julia  
**Cc:** Brian Treble <[btreble@westlincoln.ca](mailto:btreble@westlincoln.ca)>  
**Subject:** RE: FOI Request for building permit information

Dear Julia:

Thank you for your email.

I have been gathering information in order to respond to your FOI request. I am sorry but I cannot confirm if I will be able to meet your April 15<sup>th</sup> deadline as I am still reviewing the information. Also, I must advise you that if my decision is to release the documents to you that you have requested, I will have to notify the owner of the property who will have the opportunity to appeal my decision which may further delay the provision of documentation to you.

With respect to releasing the documents to the MOE, please be advised that, in this instance, the MOE would be required to follow the same FOI request procedure that you are following.

**Carolyn Langley, Clerk**

Township of West Lincoln  
318 Canborough Street  
P.O. Box 400  
Smithville, Ontario.  
L0R 2A0

Tel: (905) 957-3346 ext. 6720

Fax: (905) 957-3219

\*\*\*\*\*

This email may contain confidential and/or privileged information for the sole use of the intended recipient. Any review, disclosure, or distribution by others is strictly prohibited. If you have received this email in error, please contact the sender immediately and delete all copies.

---

**From:** Kossowski, Julia [<mailto:Julia.Kossowski@stantec.com>]  
**Sent:** April-04-14 9:29 AM  
**To:** Carolyn Langley; Brian Treble  
**Cc:** Powell, Chris  
**Subject:** FOI Request for building permit information

Good Morning Brian and Carolyn,

I am just following up on my FOI request submitted last week for 6374 Concession Road 4. This information has been requested so that we can respond to questions from the Ministry of Environment. The MOE has now

placed a deadline for us to submit the information by April 15<sup>th</sup>. Would it be possible for you to provide us with the information before this date? Alternatively, did you have any luck acquiring approval from your lawyers to provide the information directly to the MOE?

Regards,  
Julia

**Julia Kossowski, P. Eng.**  
Project Manager - Power  
Stantec  
49 Frederick Street  
Kitchener ON N2H 6M7  
Ph: (519) 569-4338  
Fx: (519) 579-4239  
Cell: (226) 989-5259  
[julia.kossowski@stantec.com](mailto:julia.kossowski@stantec.com)

The content of this email is the confidential property of Stantec and should not be copied, modified, retransmitted, or used for any purpose except with Stantec's written authorization. If you are not the intended recipient, please delete all copies and notify us immediately.



Secondary Entrance at 6374 Concession Road 4, West Lincoln (Source: Google Streetview, Photo Taken June 2012)

## Powell, Chris

---

**From:** Miller, Denton (ENE) <Denton.Miller@ontario.ca>  
**Sent:** Wednesday, February 12, 2014 1:57 PM  
**To:** Powell, Chris  
**Cc:** Raetsen, Sarah (ENE)  
**Subject:** NRWC info request -5 Letter dated Jan 22, 2014 Receptor 3583  
**Attachments:** EBR Comment re por 3583.docx

Hello Chris

We have been approached by the owner of the lot that contains vacant lot receptor 3583 ( re: your Sept 30 , 2013 noise report; see diagram below). He has made the following assertion:

There is currently no dwelling on the property , although there is a new barn. The Township of West Lincoln now says can have the upper floor used as a dwelling, provided that changes are made to comply with the building code. The center of the existing building, erected in 2007 is 513 meters from the proposed turbine {T 93}. This building was built by us long before there was an NRWC .

All of the infrastructure on this property was placed there by us after taking possession on January 15, 2004.

Please refer to the attached document for a detailed description of all the noise issues identified by the owner of the lot and provide EAB with a response.

Your response should also address the definition of dwelling as defined Ontario Regulation 359/09 and how it applies to the existing barn on the subject property.

Thank You

DM





## Powell, Chris

---

**From:** Powell, Chris  
**Sent:** Thursday, March 06, 2014 12:08 PM  
**To:** Denton.Miller@ontario.ca  
**Cc:** Raetsen, Sarah (ENE); Leggett, Al; Ganesh, Kana; Darren Croghan  
**Subject:** RE: NRWC Info Request 6 MOE ref file # 1175-972NB9  
**Attachments:** Attachments 1 to 4.pdf; Photo 1 - 5648 Regional Road 65.PNG; Photo 2 - V794 Property.jpg

Denton,

In response to your email below, our GIS and noise leads have reviewed the receptor and turbine information contained in the REA reports to generate a response to the EBR suggestions about the accuracy of individual noise receptors. The following information is provided in regards to receptors V\_735, V\_794 and V\_1762:

1. **V\_735** – Property: 5648 Regional Road 65 (Silver Street in MNR data and Bismark Road in Niagara Explorer), West Lincoln (see Attachment 1).

During the initial development of the noise model, and identification of receptors (POR's), our field crews reviewed each of the potential POR's to confirm and verify the appropriate classification of existing structures. Based on their site investigations, our field crew identified this particular property as "potentially commercial – similar to a nursery" due to the presence of similar structures within the property. The location of the receptor is correct, however, the designation could be revised. Regardless, this residence is located 920 m from the closest turbine (T54) and the noise level at this receptor is 36.9 dBA, which is below the 40.0 dBA threshold. A photograph of the subject property is attached for reference (see Photo 1).

Action: The designation of this existing structure will be revised from "vacant" to "existing" in order to reflect the existing dwelling.

2. **V\_794** – Property: No specific mailing address exists for this property, which is located on Regional Road 65 (Silver Street in MNR data and Bismark Road in Niagara Explorer), West Lincoln – east of V\_735 discussed above (see Attachment 1).

Based on our review of the current aerial photography, field verification during the initial development of the noise model to identify POR's, and review of building permits prior to issuance of the draft site plan, this property is a vacant property. Based on our information, there is no existing dwelling on this property (see Photo 2) and no dwelling was approved prior to the issuance of the draft site plan. As such, a vacant lot receptor (V\_794) was appropriately located on the subject property within the noise model. The existing dwelling to the east of receptor V\_794 is located on a separate parcel of land and represented by receptor O\_3887. Both receptors comply with the minimum distance from a turbine and the noise threshold.

Action: Additional information regarding the alleged location of an existing dwelling on the subject property is requested, if available. Otherwise, our information confirms that there is no existing dwelling on the subject property and no approved dwelling prior to the issuance of the draft site plan.

3. **V\_1762** – Property: No specific mailing address exists for this property, which is located on Concession Road 4, West Lincoln (see Attachment 2).

The subject property is located at the intersection of 2 unopened road allowances - Concession 4 (running east-west along the south side of the property) and Dengo Road (running north-south along

the east side of the property. The property is also entirely comprised of significant woodland and wetland with no open areas. There is no existing dwelling on the subject property, however, a vacant lot receptor was identified for the purposes of the noise model.

It is possible that questions arising regarding the location of V\_1762 may be in regards to its location relative to a potential dwelling located on the property to the north (2090 Dengo Road, West Lincoln). This property is represented in the noise model by receptor O\_1758 (2090 Dengo Road, West Lincoln coordinate 623376.46; 623376.46), which is located at the north of the property adjacent to the open portion of Dengo Rd.

Through air photo interpretation, a second structure is also located at the south of this property (i.e. closer to V\_1762 but on the adjacent parcel) (see Attachment 2). This second structure could be a dwelling, however verification of this structure was not possible through the physical verification process due to property access and isolation of the property. It appears to be accessible only from a private road that extends from the end of the opened section of Dengo Rd. at the north of the property and is not visible from a municipal right of way.

Nonetheless, this structure was recognized during the development of the noise model and project layout. While not confirmed as a receptor in the noise model, our noise team ensured that it remained outside of the appropriate setbacks and below the noise threshold. As a result, this structure is located 780 m from the closest turbine (T27) and the noise level at this receptor is 38.7 dBA, which is below the 40.0 dBA threshold.

Action: We defer to the MOE as to how to address this potential second noise receptor on the property (i.e. shift location O\_1958, or add an additional receptor to the model). In terms of V\_1762, our information confirms that there is no existing dwelling on that property or no approved dwelling prior to the issuance of the draft site plan.

The following information is provided in regards to the closest turbine to receptors O\_148, O\_582 and O\_674:

4. **O\_148** – Property 7057 Concession 4 Road, West Lincoln (see Attachment 3).

This receptor is correctly positioned on an existing dwelling that fronts onto Concession 4. As illustrated on Attachment 3, Turbine T81 is correctly identified as the closest turbine to receptor O\_148 (distance = approx. 1,180 m). Despite the EBR comments below, Turbine T08 is not even the second closest turbine to this receptor (Turbines T52 and T53 are the next nearest). Turbine T08 is located approximately 2806 m from receptor O\_148.

5. **O\_582** – Property: 6367 Elcho Road, West Lincoln (see Attachment 4).  
**O\_674** – Property: 6227 Elcho Road, West Lincoln (see Attachment 4).

Both of these receptors are correctly positioned on existing dwellings fronting onto Elcho Rd. As illustrated on Attachment 4, the closest turbine to these receptors is Turbine T07, located 612 m and 558 m away, respectively.

These responses are based on the information collected during the preparation of the noise model and project layout, including existing mapping, air photo interpretation, site investigations and consultation with the Township of West Lincoln to identify newly approved / potentially unconstructed dwellings or other possible noise receptors.

We trust that this additional information addresses the comments provided in the EBR comment below.

If you have any further questions, please do not hesitate to let us know.

Sincerely,

Chris

**Chris Powell, M.A.**

Project Manager, Environmental Planner  
Stantec  
49 Frederick Street Kitchener ON N2H 6M7  
Phone: (519) 585-7416  
Cell: (519) 501-2368  
Fax: (519) 579-6733  
Chris.Powell@stantec.com



The content of this email is the confidential property of Stantec and should not be copied, modified, retransmitted, or used for any purpose except with Stantec's written authorization. If you are not the intended recipient, please delete all copies and notify us immediately.

 Please consider the environment before printing this email.

---

**From:** Miller, Denton (ENE) [<mailto:Denton.Miller@ontario.ca>]  
**Sent:** Friday, February 21, 2014 2:49 PM  
**To:** Powell, Chris  
**Cc:** Raetsen, Sarah (ENE)  
**Subject:** NRWC Info Request 6 MOE ref file # 1175-972NB9

Hello Chris

Comments via the EBR allege that the following three lots were incorrectly identified as vacant lots (existing dwellings are alleged to be present) .

1. 735,
2. 794 and
3. 1762

The correspondence further states that following three receptors are not correctly referenced from a distance perspective to the closest proposed turbine.

1. 582,
2. 674 and
3. 148

Please review the above issues and respond to this E-mail by **March 7, 2014**.

The EBR comment is copied below for your reference (yellow highlight).

Thank you

*Regards*  
*Denton Miller*  
416-314-8310

---

**From:** XXXXXXXX

**Sent:** February 17, 2014 6:03 PM

**To:** XXXXXX

**Cc:** XXXXXX

**Subject:** Fw: Mistakes

Ladies

It is difficult to respect and support the role that the MOE is taking in the supervisory role of the two wind projects in West Lincoln. I refer of course to the HAF/IPC project and the pending NRWC project. (012-0613). Several years ago MOE guidelines which we have respected were written to guide the big business wind enterprises that would invade our province. The only problem which is evidencing itself now is that those guidelines can have numerous exceptions in favour of the wind companies....they can BE changed, omitted, redirected or ignored. ALL those guidelines were supposedly developed to protect rural Ontario. Rural residents can no longer demand respect from the bullies you call Wind Companies.

There have been five infractions during the HAF/IPC development. I have already listed these for you in a previous e-mail dated February 9th, 2014. The most recent mistake....the positioning of 3 out of 5 turbines too close to non host property lines is the ultimate mistake. Unfortunately.... the wind developer is not prepared to correct his mistakes. The MOE is prepared to allow the company to correct their errors retroactively. The non host property owners may have to take the company to further litigation in a court of law.

Also the MOE did not complete due diligence in the Burnaby Skydiving facility in Wainfleet when IWTs were approved so close to a functioning skydiving business. This tells me that the provincial government MOE agency just slides along and shows neglect instead of working in a supervisory capacity.

Does the MOE not appreciate that the lives of rural Ontarians are in the hands of this supervisory division??? The outline of rules and regulations devised by the MOE with regard to monitoring BIG WIND COMPANIES appears to have evolved into a complete waste of time. Like all policing efforts.... rules mean nothing if they are not enforced. You break the rules. You pay the cost. In the case of HAF/IPC the non compliant wind turbines MUST come down or be moved!!! The decision is simple. The solution is simple.

The residents of West Lincoln living in the area for the proposed NRWC project have made a commitment and mission (beyond all others) to find all the mistakes within the project. I am reluctant to help the MOE complete it's job. I would assume that the NRWC proposal is checked by the MOE for inaccuracies. There are hundreds of mistakes. Most recently we have found so many properties marked as Vacant in the Stantec/NRWC paperwork. In actuality these are occupied Non Host properties. This raises many additional questions about mistakes. How many more properties marked Vacant are really occupied properties??? They will not have been measured for accurate distances from the proposed wind turbines. (For example ....Receptors 1750, 735, 794 and 1762) Other indicated non host properties have incorrect distances from turbines. (For

example...Receptors 582 and 674 in relation to each other and T07.....and Receptor 148 is actually closest to T08 but Stantec says T81) And so on it goes.....

The supervising, monitoring and correcting tasks involved in the NRWC project are not the responsibilities of the residents of West Lincoln. These are the responsibilities of the MOE. If the NRWC wind turbines are erected without caution....the MOE will be facing numerous challenges to correct the whiffle and waffle and mess which should have been corrected long before the project was approved. I think that the MOE will find that when true coordinates are found and accurate locations are indicated, the NRWC project of 77-80 3MW IWTs may not fit into our community. And all future corrections and manoeuvring of the MOE will never make it work.

It is the task of the MOE to check everything the residents of West Lincoln have questioned ...the Natural Heritage details, distances, noise/decibel inaccuracies, the safety of our children, turbine locations, receptor inaccuracies. It is the task of the MOE to respond with due diligence.

The alternative is to cancel this project 012-0613.

Thank you,  
XXXXXX

---

Vacant Lot 735 & 794

# TOWNSHIP OF WEST LINCOLN

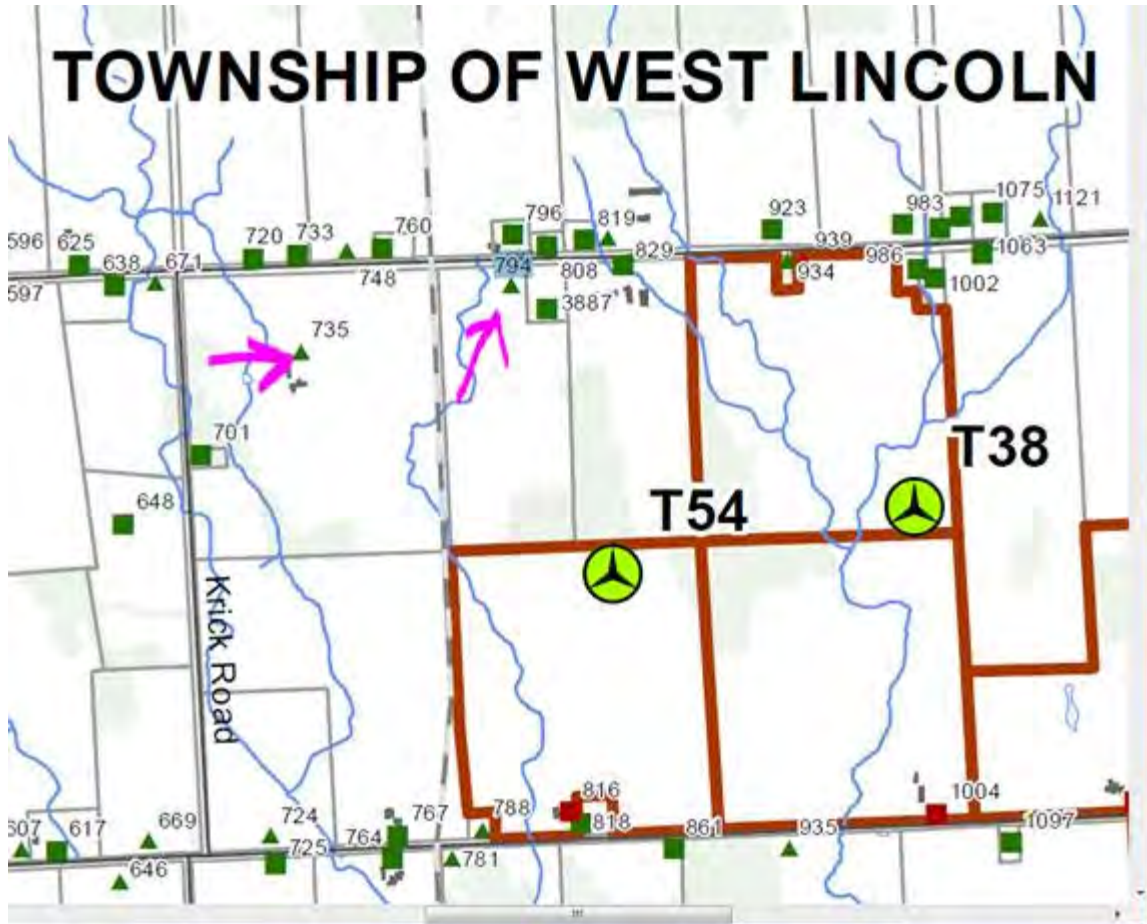

Vacant Lot 1762



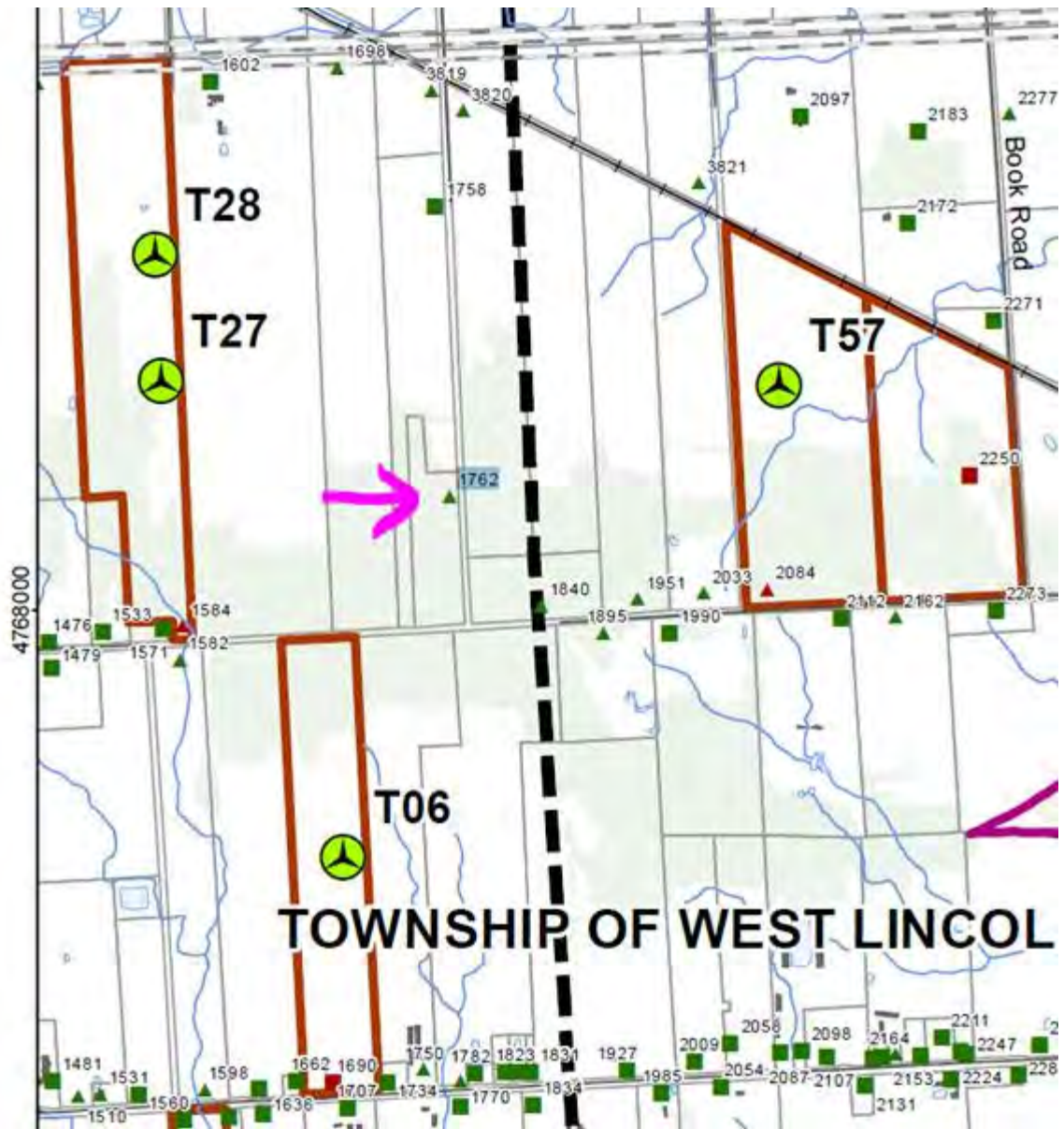



V:\01609\Active\160950269\planning\drawing\mxd\20140224\_MOE\_Receptor\_Queries\160950269\_Fig\_01\_Site\_Plan.mxd  
Revised: 2014-03-05 By: bcowper



**Legend**

- |                                    |                                    |
|------------------------------------|------------------------------------|
| Project Study Area                 | Sound Level Contours 40dBA         |
| <b>Proposed Project Components</b> | <b>Non-participating Receptors</b> |
| Proposed Turbine Location          | Occupied                           |
|                                    | Vacant                             |
| <b>Existing Features</b>           |                                    |
| Road                               |                                    |
| Abandoned Railway                  |                                    |
| Watercourse (MNR)                  |                                    |
| Property Boundary                  |                                    |

**Notes**

1. Coordinate System: NAD 1983 UTM Zone 17N).
2. Base features produced under license with the Ontario Ministry of Natural Resources © Queen's Printer for Ontario, 2011.
3. Orthoimagery source: First Base Solutions, Date Spring 2010.

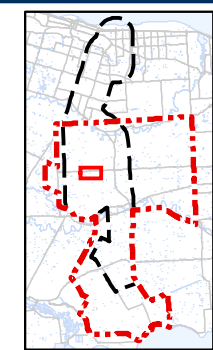

Client/Project  
Niagara Region Wind Corporation

---

Figure No.  
1

---

Title  
**Attachment 1**



March, 2014  
160950269



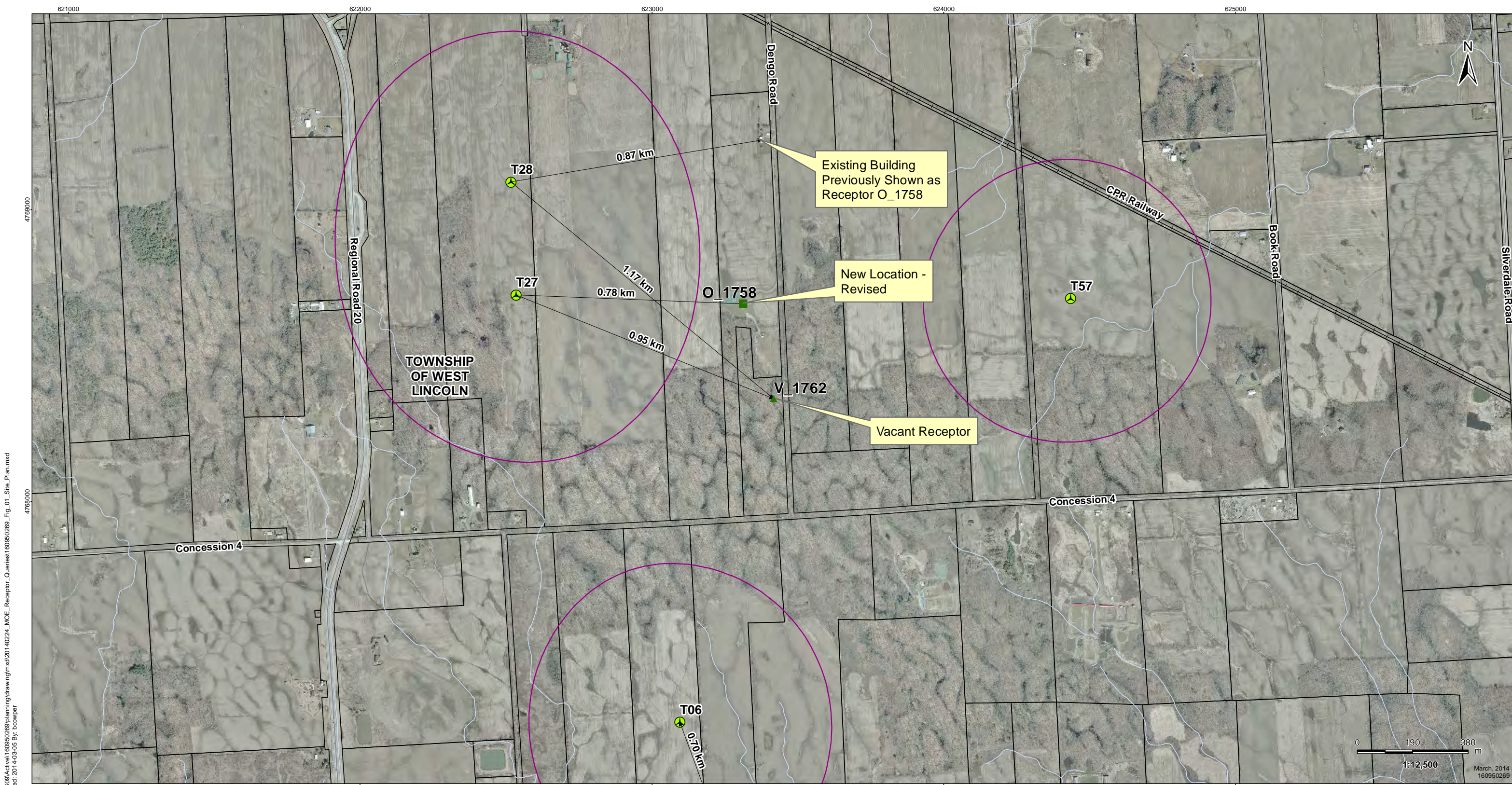

V:\01609\Active\160950269\planning\drawing\mxd\20140224\_MOE\_Receptor\_Queries\160950269\_Fig\_01\_Site\_Plan.mxd  
 Revised: 2014-03-05 By: bcowper



**Legend**

- |                             |                             |
|-----------------------------|-----------------------------|
| Project Study Area          | Sound Level Contours 40dBA  |
| Proposed Project Components | Non-participating Receptors |
| Proposed Turbine Location   | Occupied                    |
| Existing Features           | Vacant                      |
| Road                        |                             |
| Active Railway              |                             |
| Watercourse (MNR)           |                             |
| Property Boundary           |                             |

**Notes**

1. Coordinate System: NAD 1983 UTM Zone 17N).
2. Base features produced under license with the Ontario Ministry of Natural Resources © Queen's Printer for Ontario, 2011.
3. Orthoimagery source: First Base Solutions, Date Spring 2010.

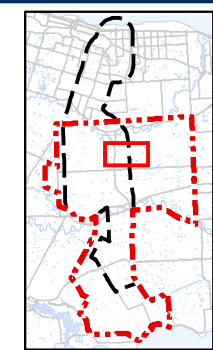

Client/Project  
 Niagara Region Wind Corporation

---

Figure No.  
 2

---

Title  
**Attachment 2**

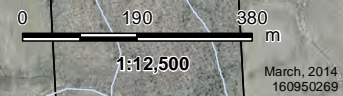



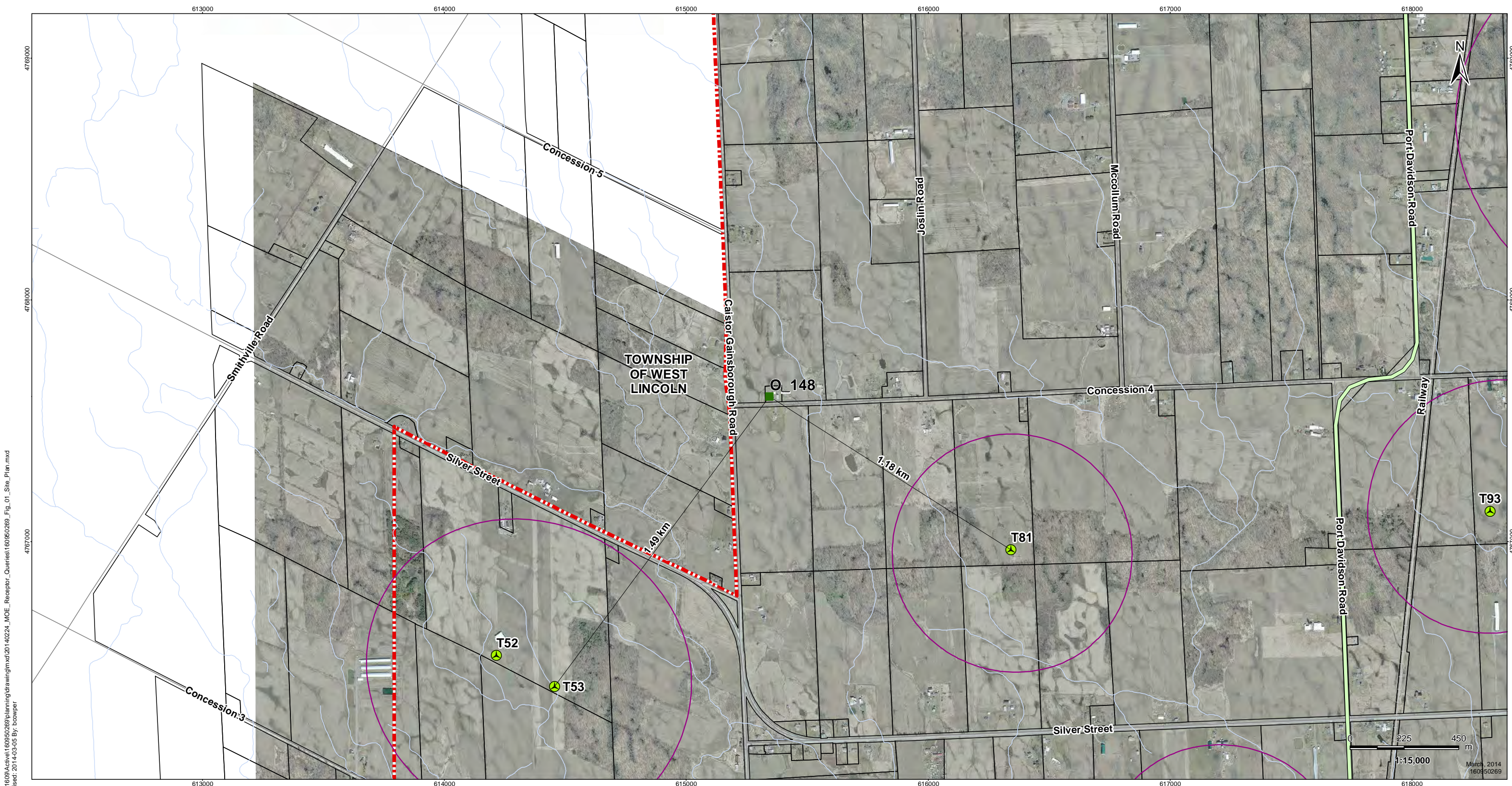

V:\01609\Active\160950269\planning\drawing\mxd\20140224\_MOE\_Receptor\_Queries\160950269\_Fig\_01\_Site\_Plan.mxd  
 Revised: 2014-03-05 By: bcowper



**Legend**

- |                                    |                                    |
|------------------------------------|------------------------------------|
| Project Study Area                 | Sound Level Contours 40dBA         |
| <b>Proposed Project Components</b> | <b>Non-participating Receptors</b> |
| Proposed Turbine Location          | Occupied                           |
| Preferred Transmission Line Route  | Vacant                             |
| <b>Existing Features</b>           |                                    |
| Road                               |                                    |
| Abandoned Railway                  |                                    |
| Watercourse (MNR)                  |                                    |
| Property Boundary                  |                                    |

**Notes**

1. Coordinate System: NAD 1983 UTM Zone 17N).
2. Base features produced under license with the Ontario Ministry of Natural Resources © Queen's Printer for Ontario, 2011.
3. Orthomagery source: First Base Solutions, Date Spring 2010.

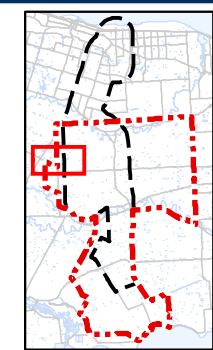

Client/Project  
Niagara Region Wind Corporation

---

Figure No.  
3

---

Title  
**Attachment 3**



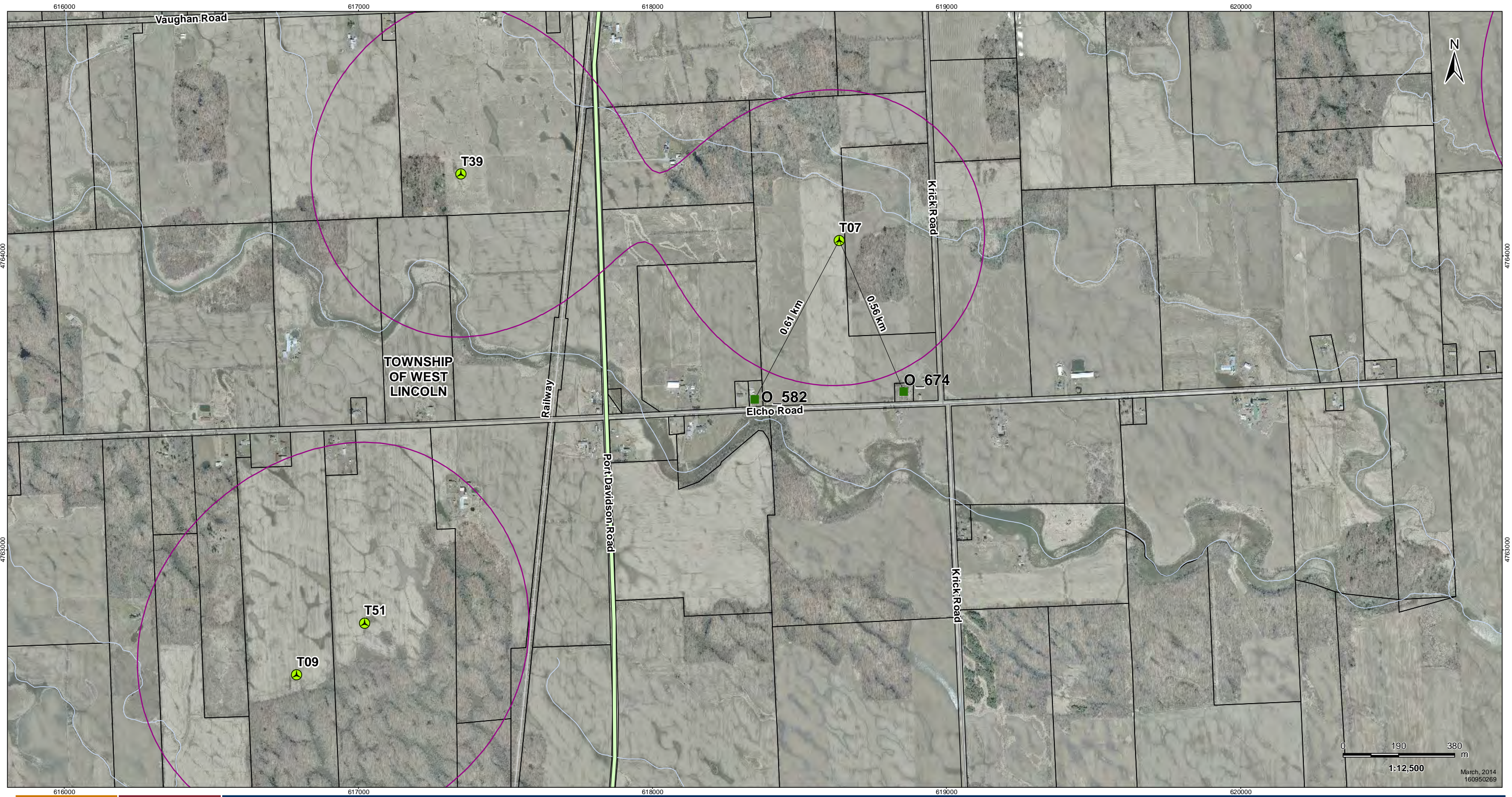

V:\01609\Active\160950269\planning\drawing\mxd\20140224\_MOE\_Receptor\_Queries\160950269\_Fig\_01\_Site\_Plan.mxd  
 Revised: 2014-03-05 By: bcowper



**Legend**

- |                                    |                                    |
|------------------------------------|------------------------------------|
| Project Study Area                 | Sound Level Contours 40dBA         |
| <b>Proposed Project Components</b> | <b>Non-participating Receptors</b> |
| Proposed Turbine Location          | Occupied                           |
| Preferred Transmission Line Route  | Vacant                             |
| <b>Existing Features</b>           |                                    |
| Road                               |                                    |
| Abandoned Railway                  |                                    |
| Watercourse (MNR)                  |                                    |
| Property Boundary                  |                                    |

**Notes**

1. Coordinate System: NAD 1983 UTM Zone 17N).
2. Base features produced under license with the Ontario Ministry of Natural Resources © Queen's Printer for Ontario, 2011.
3. Orthimagery source: First Base Solutions, Date Spring 2010.

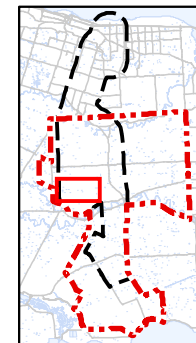

Client/Project  
Niagara Region Wind Corporation

Figure No.  
4

Title  
**Attachment 4**

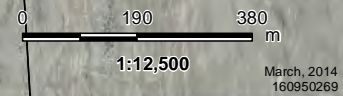









11 X

Report a problem

© 2014 Google - Image Date: August 2012

## Powell, Chris

---

**From:** Powell, Chris  
**Sent:** Thursday, March 13, 2014 6:04 PM  
**To:** Denton.Miller@ontario.ca  
**Cc:** Raetsen, Sarah (ENE); Darren Croghan; Leggett, Al (Al.Leggett@stantec.com); Ganesh, Kana  
**Subject:** Re: NRWC Info request 7  
**Attachments:** Receptors 1481 to 1598 - Fig 2-27.jpg; Photo 1560.png; Photo\_1510\_1531.png

Denton,

The following noise receptors are identified between Receptors 1481 and 1598 in the noise model and on the site plan figures (see attached screen capture from Figure 2.27 of the PDR):

Receptor	Noise	Setback to Turbine	Closest Turbine	Description (see attached photos)
V_1510	37.1 dBA	1039 m	T01	"Photo 1510_1531" – large house like building (similar to a hotel or Bed and Breakfast) at left of photo;
V_1531	37.4 dBA	998 m	T01	"Photo 1510_1531" – existing building with garages
O_1560	37.9 dBA	927 m	T01	"Photo 1560" – existing dwelling

All of these receivers satisfy the noise threshold of 40.0 dBA and are setback a minimum of 550m from the nearest turbine in accordance with O. Reg. 359/09.

Upon further reviewing our information for this area, we can confirm that all parcels between Receptors 1481 and 1598 are represented by a noise receptor and that there are no "occupied homes" that have been missed in the noise model.

We trust this addresses the comment from the public with respect the apparent missing occupied home in this area.

Sincerely,

Chris

---

**From:** Miller, Denton (ENE) [<mailto:Denton.Miller@ontario.ca>]  
**Sent:** Thursday, March 13, 2014 1:50 PM  
**To:** Powell, Chris  
**Cc:** Raetsen, Sarah (ENE)  
**Subject:** NRWC Info request 7

Hello Chris

Please review the e-mail below and :

Comment on the statement;

Between receptors 1481 and 1598, there is an occupied home that is not shown on their diagrams at all nor is it included in the NRWC reports as a receptor.

Please provide your comments by March 28, 2014.

Thank you

*Regards*  
*Denton Miller*  
*416-314-8310*

---

From:  
Sent: March 12, 2014 12:00 PM  
To: Garcia-Wright, Agatha (ENE)  
Subject: Fwd: Fw: Fwd: Letter Response- Ms. Shellie Correia- Dated March 6, 2014

Ms. Garcia-Wright,

I am in receipt of your response to my letter. However, I note that you did not comment on the MOE's processes or your intentions with regard to the errors that residents are finding in the NRWC application. I have pasted two paragraphs from my original letter in red below. What does the MOE intend to do about the abundance of errors that we have found and that we continue to find?

---

Mothers Against Wind Turbines and many Niagara residents have written to the MOE about gaps and errors in the application of the Niagara Region Wind Corporation (NRWC) project documents. We continue to find more and more errors in the NRWC documents and that is of great concern since these are the first 3MW wind turbines proposed for Ontario. Further to the issues/errors that have already been reported to you about the NRWC application, it would seem that additional mistakes have been made with respect to their "vacant" designations and some of these have already been reported to you. We have been finding more with alarming regularity and quite easily. Again, that brings into question the diligence of the MOE as well as that of the wind developers and the accuracy of their applications. As a sample, receptors 1750, 735, 794 and 1762 are all occupied homes within the definition contained in the regulations yet they show as vacant in the NRWC's reports. **Between receptors 1481 and 1598, there is an occupied home that is not shown on their diagrams at all nor is it included in the NRWC reports as a receptor.** We have other examples as well and we will continue to explore other parts of the project area to identify additional errors. Considering that we have barely initiated this exercise, it is appalling that we have already detected this many errors. Shouldn't that be the MOE's role?

It would also appear that inaccuracy in measuring distances is another issue that is common among wind developers. Mothers Against Wind Turbines is well aware of the correspondence sent to you by a resident of our community regarding the errors in the NRWC application whereby geocoded address data was used to estimate distances. Significant errors were pointed out to you in that correspondence and we will be following the MOE response and reaction in that regard. It, is yet another example of the arrogance and disrespect that wind developers display and that the MOE ignores. Why does the MOE permit this type of engineering sloppiness and why has the process been set up so that wind developers can so readily submit inaccurate data in error and by design?











## Powell, Chris

---

**From:** Powell, Chris  
**Sent:** Wednesday, April 16, 2014 9:46 AM  
**To:** Denton.Miller@ontario.ca; Raetsen, Sarah (ENE)  
**Cc:** Darren Croghan; Merv Croghan; Shiloh Berriman (sberriman@nrwc.ca); Leggett, Al (Al.Leggett@stantec.com); Ganesh, Kana; Hung, Timothy; Hassan.Shahriar@enercon.de  
**Subject:** FW: Niagara Region Wind Farm Info Request - 2e , 8 and 9 MOE ref file # 1175-972NB9  
**Attachments:** Letter regarding Sound Power Levels.pdf; Sound Power Level E-101 NRWC 140415.pdf; Sound Power Level E-82 NRWC 140415.pdf; KCE measurement excerpts E-101.pdf; KCE measurement excerpt E-82.pdf  
**Importance:** High

Denton,

In response to your email dated April 3, 2014, and further to our conference calls over this past week, we provide the following information to address your comments:

1. Info Request 2e - Sound Power Levels of the Subject Turbines

Based on follow-up discussions with Enercon, a more definitive statement confirming the use of the 104.8 dBA noise data for the E101 turbines proposed for the NRWC Project has been obtained from Enercon. Attached to this email are the following documents confirming the use of the appropriate data in the noise assessment report for this Project:

a. Letter from Enercon entitled *Sound Power Level (SPL) documents of the ENERCON Wind Energy Converters (WECs) E-101 3.0MW and the E-82 2.3MW for Niagara Region Wind Corporation (NRWC)* dated April 15, 2014, and corresponding attachments.

- 1) Sound Power Level E-101 NRWC dated April 15, 2014
- 2) KÖTTER measurement excerpts dated April 23, 2013 and March 13, 2013
- 3) Sound Power Level E-82 NRWC dated April 15, 2014
- 4) KÖTTER measurement excerpt dated February 8, 2010

This letter provides the additional confirmation requested in your last email and greater certainty with respect to the sound power level information for the turbines being proposed for the NRWC Project.

2. Info Request 8 – Munich Higher Regional Court's Decision pertinent to impulsive sound from Enercon E-82 wind turbines

The following comments have been provided by Enercon in response to MOE's request for information on this issue:

*The article referenced is in regard to a claim and subsequent ruling which has been made against ENERCON regarding the impulsivity of E-82 turbines in one of its wind parks near Munich, Germany.*

*ENERCON is in full disagreement with the ruling and are launching a full appeal against the region. In response, as per the official comments from ENERCON GmbH made on this issue.*

*"for us, this ruling is completely incomprehensible", says Felix Rehwald, Spokesperson for Europe's largest wind turbine manufacturer Enercon.*

*He continues to comment that ENERCON manufactures, sells and guarantees its turbines worldwide against tonality (in accordance with the IEC standards) and furthermore that Enercon's own specialists in sound power have yet to yield any measurements which would indicate impulsivity of the turbines and as such, Enercon is launching counter-proceedings in the way of an appeal against the ruling.*

*The court case in Germany is not related to the NRWC project from a technical and environmental permitting perspective.*

3. Info Request 9 – Cadna files for Existing Rosa Flora Turbine

In regards to the questions raised pertaining to the Cadna files, we will circulate the correct Cadna files to the MOE under a separate email, which will be available via an FTP site for your review. The Cadna file will illustrate the correct sound power level (103.5 dBA) for the Rosa Flora Turbine, as it was used in the noise model to generate the results in the Noise Assessment Report dated September 2013.

The Cadna file previously provided on March 17, 2014 identifying a sound power level for this turbine of 101 dBA (correction factor of -2.5 dBA) was not used in the modelling exercise for this Project.

The Rosa Flora turbine is a 0.65 MW turbine located approximately 3,500 m from the nearest NRWC turbine. As per the Noise Assessment Report, the maximum sound power level for this turbine used in the model was 103.5 dBA (Section 3.3, page 3.9), which was rounded to 104 in Table 3.8. This is further confirmed in the sample calculation and Cadna/A input/outputs table provided in Appendix E and in the adjusted emission level for the Rosa Flora turbine identified in Table F1 of Appendix F of the Noise Assessment Report (Stantec, September 2014).

Based on the above, we trust that the above information is sufficient to address MOE's concerns as expressed in your email dated April 3, 2014.

If you have any questions, please do not hesitate to call.

Sincerely,

Chris

**Chris Powell, M.A.**

Project Manager, Environmental Planner  
Stantec  
49 Frederick Street Kitchener ON N2H 6M7  
Phone: (519) 585-7416  
Cell: (519) 501-2368  
Fax: (519) 579-6733  
Chris.Powell@stantec.com



The content of this email is the confidential property of Stantec and should not be copied, modified, retransmitted, or used for any purpose except with Stantec's written authorization. If you are not the intended recipient, please delete all copies and notify us immediately.

Please consider the environment before printing this email.

---

**From:** Miller, Denton (ENE) [<mailto:Denton.Miller@ontario.ca>]

**Sent:** Thursday, April 03, 2014 1:40 PM

**To:** Kossowski, Julia

**Cc:** Raetsen, Sarah (ENE); Powell, Chris; Ganesh, Kana; Leggett, Al; [darrenc@nrwc.ca](mailto:darrenc@nrwc.ca); Shiloh Berriman; [mervcroghan@nrwc.ca](mailto:mervcroghan@nrwc.ca); Hung, Timothy

**Subject:** FW: Niagara Region Wind Farm Info Request - 2e , 8 and 9 MOE ref file # 1175-972NB9

Hi Chris / Julia

Below are:

1. Additional comments to info request 2 ( Sound Power Levels of the subject turbines) ,
2. Two new information requests ( 8 & 9), and
3. A summary of the information requests to date ( attached).

---

### 1. Additional comments to Info Request 2

With respect to Enercon's attached document, I still have concerns with their specification of the applicable sound power level {RE: Section 6.2.2. of Noise Guidelines for Wind Farms}.

Specifically the use of the word suggests is problematic. ( reference copied below) .

The 104.8 dBA as presented in the Kotter document dated April 23, 2013 coincides with the Sound Power Level guarantee (95% rated power or higher) provided by ENERCON to the Niagara Region Wind Corporation. As such, ENERCON suggests that this document is more applicable to the Niagara Region Wind Corporation facility as opposed to the estimated 106 dBA presented in the ENERCON document.

Consequently, in the absence of a definitive statement from Enercon , I will be contacting you next week to discuss how my review will address this issue.

---

### 2. Info Request 8

Please ask Enercon to comment on the following court decision identified via an EBR comment:

*The Munich Higher Regional Court's decision pertinent to impulsive sound from Enercon E-82 wind turbines in a wind farm located in Rennertshofen in the district of Neuburg-Schrobenhausen. Judgment OLG München 14.08.2012*

Specifically;

1. What was the issue?
2. What was the outcome? and
3. How is this issue related to the turbines proposed in the NRWC

Please provide comments by April 17, 2014.

---

### 3. Info Request 9:

The Cadna files note the following sound power level (101.0 dBA) for Rosa Flora Turbine:



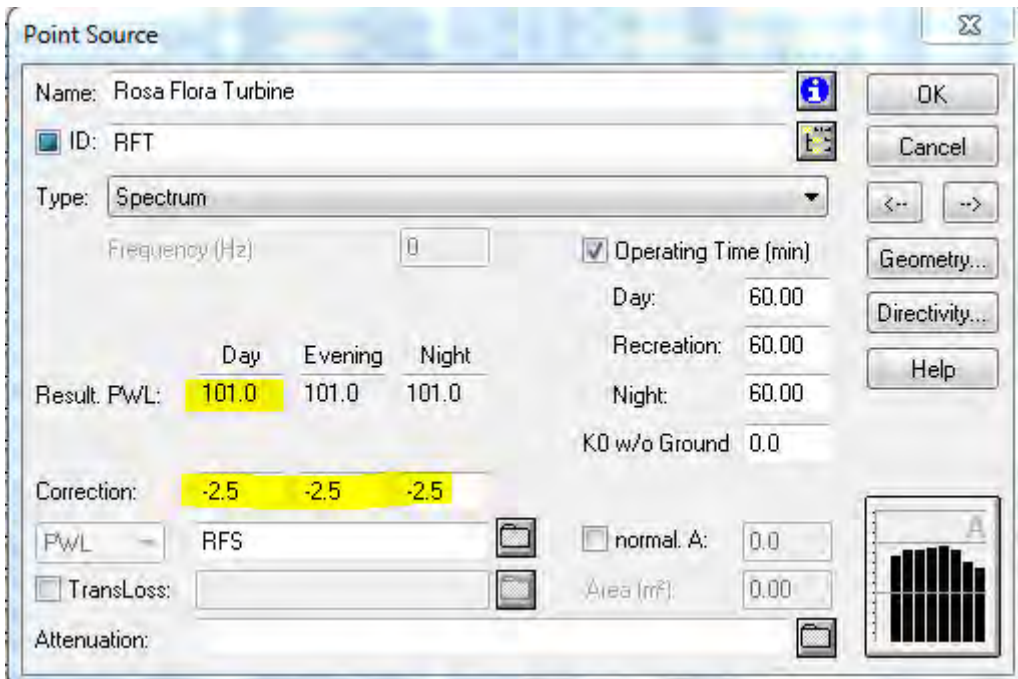

The Noise Report notes the following sound power level (104 dBA) for the same turbine .

**Table 3.8 Assessed Noise Sources Associated with Adjacent or Proposed Wind Farms within 5 km**

Source ID	Source Description	Sound Power Level [dBA]	UTM Coordinates		
			X [m]	Y [m]	Z [m]
RF	Rosa Flora Turbine	104	615270	4756417	75

Please comment on the oversight between both sources of data, and the potential impact on the calculated sound pressure levels.

Please provide comments by April 17, 2014.

*Regards*  
*Denton Miller*  
 416-314-8310

---

**From:** Kossowski, Julia [<mailto:Julia.Kossowski@stantec.com>]  
**Sent:** March 25, 2014 4:35 PM  
**To:** Miller, Denton (ENE)  
**Cc:** Raetsen, Sarah (ENE); Powell, Chris; Ganesh, Kana; Leggett, Al; [darrenc@nrwc.ca](mailto:darrenc@nrwc.ca); Shiloh Berriman ([sberriman@nrwc.ca](mailto:sberriman@nrwc.ca)); [mervcroghan@nrwc.ca](mailto:mervcroghan@nrwc.ca); Hung, Timothy  
**Subject:** FW: Niagara Region Wind Farm Info Request -2e MOE ref file # 1175-972NB9

Hello Denton,

On behalf of Chris Powell and NRWC, please find attached ENERCON's request to your email below dated March 17, 2014.

Please contact us if you require additional information.

Kind Regards,  
Julia

**Julia Kossowski, P. Eng.**  
Project Manager - Power  
Stantec  
49 Frederick Street  
Kitchener ON N2H 6M7  
Ph: (519) 569-4338  
Fx: (519) 579-4239  
Cell: (226) 989-5259  
[julia.kossowski@stantec.com](mailto:julia.kossowski@stantec.com)

The content of this email is the confidential property of Stantec and should not be copied, modified, retransmitted, or used for any purpose except with Stantec's written authorization. If you are not the intended recipient, please delete all copies and notify us immediately.

---

**From:** Miller, Denton (ENE) [<mailto:Denton.Miller@ontario.ca>]  
**Sent:** Monday, March 17, 2014 02:37 PM  
**To:** Powell, Chris; Raetsen, Sarah (ENE) <[Sarah.Raetsen@ontario.ca](mailto:Sarah.Raetsen@ontario.ca)>; Hung, Timothy  
**Cc:** Ganesh, Kana; Leggett, Al; 'darrenc@nrwc.ca' <[darrenc@nrwc.ca](mailto:darrenc@nrwc.ca)>; 'sberriman@nrwc.ca' <[sberriman@nrwc.ca](mailto:sberriman@nrwc.ca)>; 'mervcroghan@nrwc.ca' <[mervcroghan@nrwc.ca](mailto:mervcroghan@nrwc.ca)>  
**Subject:** RE: Niagara Region Wind Farm Info Request -2e MOE ref file # 1175-972NB9

Thank you for your response Chris.

**Summary :**

ENERCON considers the measurements values to be satisfactory representative values of the E-101 3,050 kW and E-82 E2 2,300 kW noise levels.

Frequency (Hz)	Octave band sound power level in dB(A)							
	63	125	250	500	1,000	2,000	4,000	8,000
E-101 3,050 kW @ 8.3m/s	86.3	91.6	98.6	100.8	98.3	92.8	85.9	73.3
E-82 E2 2,300 kW @ 9 m/s	86.6	94.6	94.3	97.3	98.7	93.8	81.5	73.4

**ISSUE:**

Unfortunately the response from Enercon (satisfactory representative) is not definitive enough for our review purposes. It is requested that Enercon explain why they have published at least two different data sheets for the

same equipment ( E-101), that have different values for the 95% rated capacity sound power levels (106 dBA and 104.8 dBA)?

It is also requested that Enercon explain why the above sound power levels for the E-101 are applicable to the Niagara Region Wind Corporation facility as opposed to the 106 dBA data that was referenced in a previous e-mail ?

Please provide a response by **March 25, 2014**.

*Regards*  
*Denton Miller*  
*416-314-8310*

---

**From:** Powell, Chris [<mailto:Chris.Powell@stantec.com>]  
**Sent:** March 17, 2014 1:25 PM  
**To:** Miller, Denton (ENE); Raetsen, Sarah (ENE); Hung, Timothy  
**Cc:** Ganesh, Kana; Leggett, Al; 'darrenc@nrwc.ca'; 'sberriman@nrwc.ca'; 'mervcroghan@nrwc.ca'  
**Subject:** RE: Niagara Region Wind Farm Info Request -2d MOE ref file # 1175-972NB9

Denton,

The attached information has been provided by Enercon in response to your email dated March 12, 2014. The values contained in the attachment provide the A-weighted values for the E-101 and E-82 turbines to 95% rated capacity, while the values included in Table 3.2 of the Noise Assessment Report (as attached to your email) are linear weighted values. The A-weighted values provided by Enercon in the attached table are consistent with the information provided previously by Enercon to Stantec for use in the noise model. These values were converted to linear weighted values following standard conversion methods and incorporated accordingly into the noise model and Noise Assessment Report.

In regards to your second comment, the requested Cadna-A file has been provided under a separate email earlier today for your review.

We trust that this information will be sufficient. If you have any further questions, please do not hesitate to ask.

Sincerely,

Chris

**Chris Powell, M.A.**  
Project Manager, Environmental Planner  
Associate, Environmental Services  
Stantec Consulting Ltd.

Office: (519) 585-7416  
Cell: (519) 501-2368  
[chris.powell@stantec.com](mailto:chris.powell@stantec.com)

---

**From:** Miller, Denton (ENE) [[Denton.Miller@ontario.ca](mailto:Denton.Miller@ontario.ca)]  
**Sent:** March 12, 2014 12:22 PM  
**To:** Powell, Chris; Raetsen, Sarah (ENE); Hung, Timothy  
**Cc:** Ganesh, Kana; Leggett, Al; 'darrenc@nrwc.ca'; 'sberriman@nrwc.ca'; 'mervcroghan@nrwc.ca'  
**Subject:** RE: Niagara Region Wind Farm Info Request -2d MOE ref file # 1175-972NB9

Thank you for your response Chris

**Summary:**

In accordance with Section 6.2.2 of the Noise Guidelines for Wind Farms your firm was requested to provide the sound power levels, frequency spectra in octave bands (63 to 8000 Hz), and tonality at integer wind speeds from 6 to 10 m/s for the subject wind turbines. ( E-82 & E-101)

Your firm responded (para-phrased) that this information is not necessary, as your analysis based on the 95% rated capacity sound power levels of the turbines. (This approach is acceptable to MOE.)

Enercon further notes (Mar 7, 2014 e-mail) that the SPL of the E-82 and the E-101 Wind Energy Converters (WECs) do not exceed beyond the values at 95% rated capacity for hub heights specified in its [Sound Power Level documents](#).

**Issue:**

There are several different Enercon documents noting different values for the 95% rated capacity sound power levels. For example:

1. There is a April 2013 Enercon document (attached) noting that the 95% rated capacity sound power level for the E-101 3050 kW turbine is **106 dBA**. ( NRWC report states this value to be **104.8 dBA**) {it is acknowledged that the ratings differ by 50 kW, Niagara turbines are smaller}
2. There is a April 2010 Enercon document (attached) noting that the 95% rated capacity sound power level for the E-82 2000 kW turbine is 103.5 dBA; (NRWC report states this value to be 103.3 dBA) {it is acknowledged that the ratings differ by 300 kW – Niagara turbines are larger}

**Requests:**

1. Please provide by **March 20, 2014**, a written statement from Enercon confirming that the values noted in Table 3.2 of your Report ( Sept 30, 2013) are accurate. (For reference the table is copied below.)

**Table 3.2 Highest Wind Turbine Sound Emission Corresponding to 95% or above Rated Electrical Output Power**

Description	Octave Band Sound Power Level (dB ref. 10-12 Watts)								dB/dBA
	63	125	250	500	1k	2k	4k	8k	
ENERCON model E101 model at 8.3 m/s	112.5	107.7	107.2	104.0	98.3	91.6	85	74.4	113.9/ 104.8
ENERCON model E82 model at 9 m/s	112.8	110.8	103	100.5	98.7	92.6	80.5	74.5	115.5/ 103.3

2. Please also forward the cadna A file (s) to this office.

*Regards*  
*Denton Miller*  
*416-314-8310*

---

**From:** Powell, Chris [<mailto:Chris.Powell@stantec.com>]

**Sent:** March 7, 2014 4:17 PM

**To:** Miller, Denton (ENE); Raetsen, Sarah (ENE); Hung, Timothy

**Cc:** Ganesh, Kana; Leggett, Al; 'darrenc@nrwc.ca'; 'sberriman@nrwc.ca'; 'mervcroghan@nrwc.ca'

**Subject:** RE: Niagara Region Wind Farm Info Request -2c MOE ref file # 1175-972NB9

Denton,

In preparing the Noise Assessment Report, Stantec and NRWC understood this issue and the requirements outlined in the MOE Noise Guidelines for Wind Farms. This issue was raised by NRWC and discussed during the project design stage with the manufacturer, who confirmed that despite the change in power with wind speed and height their guaranteed maximum sound power at rated capacity would not change for the proposed turbine models, and that tonality would not result at these higher turbine heights or wind speeds. This was confirmed and guaranteed through a separate letter from Enercon, which has been provided to the MOE as part of the Noise Assessment Report.

Following your email, we have discussed this further with Enercon and they have prepared additional information to address your specific comment with respect to hub height and tonality (see attached). In the supplemental information, they have reconfirmed the following:

1. that the sound power levels of the E82 and E101 turbines do not exceed beyond the values at 95% rated capacity,
2. that the turbines shall not exceed the guaranteed maximum sound power levels for hub heights specified; and
3. that the tonal audibility shall be equal to or less than 2 dB over the whole operational range, including at wind speeds of 10m/s.

Stantec confirms that the analysis provided in the Noise Assessment Report considered the spectral sound power data (i.e. frequency based data) based on the IEC test and overall sound power level corresponding to 95% rated electrical output power as guaranteed by the manufacturer (Enercon). The manufacturer has confirmed that the sound power level at 95% rated capacity is independent of height and wind speeds and has addressed the tonality concerns in a separate letter attached.

The MOE raised similar concerns during the screening of REA application for completeness and we provided additional discussion and rationale at that time. We understood that this additional information was sufficient to address your concern, but trust that the supplemental information now provided by Enercon further supports the completion of your technical review.

If you require further information in this regard, we request that a meeting be held to review and discuss this issue with our noise experts as soon as possible.

Sincerely,

Chris

**Chris Powell, M.A.**

Project Manager, Environmental Planner  
Stantec  
49 Frederick Street Kitchener ON N2H 6M7  
Phone: (519) 585-7416  
Cell: (519) 501-2368  
Fax: (519) 579-6733  
Chris.Powell@stantec.com

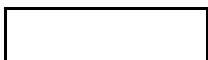



 Please consider the environment before printing this email.

---

**From:** Miller, Denton (ENE) [<mailto:Denton.Miller@ontario.ca>]  
**Sent:** Friday, February 21, 2014 12:39 PM  
**To:** Powell, Chris; Raetsen, Sarah (ENE); Hung, Timothy  
**Cc:** Ganesh, Kana; Leggett, Al; 'darrenc@nrwc.ca'; 'sberriman@nrwc.ca'; 'mervcroghan@nrwc.ca'  
**Subject:** RE: Niagara Region Wind Farm Info Request -2c MOE ref file # 1175-972NB9

Hello Chris

I have yet to receive a response to the e-mails I sent to your office on January 24, and 30 , 2014 regarding the sound power levels of the proposed turbines (questions 2 & 3 in the January 24, 2014 email to your office; copied below).

Please provide a response by **March 7, 2014**. If your firm is unable to provide a response by this date I will have to stop the clock on our service guarantee time.

If you have any questions , please feel free to contact me.

PS:  
I also have additional questions via EBR comments pertinent to vacant lots which I will send to you in a separate e-mail later today.

*Regards*  
*Denton Miller*  
*416-314-8310*

---

**From:** Powell, Chris [<mailto:Chris.Powell@stantec.com>]  
**Sent:** January 30, 2014 8:29 AM  
**To:** Miller, Denton (ENE); Raetsen, Sarah (ENE); Hung, Timothy  
**Cc:** Ganesh, Kana; Leggett, Al; 'darrenc@nrwc.ca'; 'sberriman@nrwc.ca'; 'mervcroghan@nrwc.ca'  
**Subject:** Re: Niagara Region Wind Farm Information request -2 MOE ref file # 1175-972NB9

Ok. I'll follow up with Kana and we will get back to you shortly.

Chris  
Chris Powell, M.A.  
Project Manager  
Environmental Planner  
Stantec  
Cell: (519) 501-2368

Sent from my Blackberry

---

**From:** Miller, Denton (ENE) [<mailto:Denton.Miller@ontario.ca>]  
**Sent:** Thursday, January 30, 2014 08:26 AM  
**To:** Powell, Chris; Raetsen, Sarah (ENE) <[Sarah.Raetsen@ontario.ca](mailto:Sarah.Raetsen@ontario.ca)>; Hung, Timothy  
**Cc:** Ganesh, Kana; Leggett, Al; Darren Croghan <[darrenc@nrwc.ca](mailto:darrenc@nrwc.ca)>; Shiloh Berriman ([sberriman@nrwc.ca](mailto:sberriman@nrwc.ca)) <[sberriman@nrwc.ca](mailto:sberriman@nrwc.ca)>; Merv Croghan <[mervcroghan@nrwc.ca](mailto:mervcroghan@nrwc.ca)>

**Subject:** RE: Niagara Region Wind Farm Information request -2 MOE ref file # 1175-972NB9

Hello Chris.

Thank you for your response to my questions noted in your previous e-mail (January 29, 2014 10:40 AM).

The e-mail has answered question # 1 (RE: Participating Receptors), however questions 2 and 3 still require attention.

Below is additional rationale as to why questions # 2 and 3 will require further clarification from your firm:

**Rationale:**

Documents prepared by the International Electrotechnical Commission note that the apparent sound power level is correlated to the acoustic reference wind speed and not to the wind speed at hub height. An increase in hub height will increase the apparent sound power level and might have an unpredictable effect on tonality.

The following examples from Enercon publications note this phenomenon:

Example 1: Sound Power Level for the E-82 with 2300 kW rated power

in relation to wind speed at 10 m height				
hub height $V_s$ in 10 m height	78 m	85 m	98 m	108 m
5 m/s	96,3 dB(A)	96.6 dB(A)	97.2 dB(A)	97.5 dB(A)
6 m/s	100.7 dB(A)	101.0 dB(A)	101.6 dB(A)	101.9 dB(A)
7 m/s	103.3 dB(A)	103.5 dB(A)	103.6 dB(A)	103.6 dB(A)
8 m/s	104.0 dB(A)	104.0 dB(A)	104.0 dB(A)	104.0 dB(A)
9 m/s	104.0 dB(A)	104.0 dB(A)	104.0 dB(A)	104.0 dB(A)
10 m/s	104.0 dB(A)	104.0 dB(A)	104.0 dB(A)	104.0 dB(A)
95% rated power	104.0 dB(A)	104.0 dB(A)	104.0 dB(A)	104.0 dB(A)

Example 2:

## Sound Power Level for the E-33 with 330 kW rated power

In relation to standardized wind speed $v_s$ at 10 m height					
hub height $v_s$ at 10 m height	37 m	44 m	49 m	50 m	
5 m/s	90.9 dB(A)	91.0 dB(A)	91.3 dB(A)	91.3 dB(A)	
6 m/s	95.1 dB(A)	96.0 dB(A)	96.5 dB(A)	96.5 dB(A)	
7 m/s	98.6 dB(A)	98.9 dB(A)	99.0 dB(A)	99.0 dB(A)	
8 m/s	99.7 dB(A)	99.8 dB(A)	99.9 dB(A)	99.9 dB(A)	
9 m/s	100.0 dB(A)	100.0 dB(A)	100.0 dB(A)	100.0 dB(A)	
10 m/s	100.0 dB(A)	100.0 dB(A)	100.0 dB(A)	100.0 dB(A)	
95% rated power	100.0 dB(A)	100.0 dB(A)	100.0 dB(A)	100.0 dB(A)	

Therefore in accordance with Section 6.2.2 of the Noise Guidelines for Wind Farms please provide the sound power levels, frequency spectra in octave bands (63 to 8000 Hz), and tonality at integer wind speeds from 6 to 10 m/s for the subject wind turbines.

I have another question which I send in a separate e-mail later today.

*Regards*  
Denton Miller  
416-314-8310

---

**From:** Powell, Chris [<mailto:Chris.Powell@stantec.com>]  
**Sent:** January 29, 2014 10:40 AM  
**To:** Miller, Denton (ENE); Raetsen, Sarah (ENE); Hung, Timothy  
**Cc:** Ganesh, Kana; Leggett, Al; Darren Croghan; Shiloh Berriman ([sberriman@nrwc.ca](mailto:sberriman@nrwc.ca)); Merv Croghan  
**Subject:** RE: Niagara Region Wind Farm Information request MOE ref file # 1175-972NB9

Denton,

In response to your email from Friday, January 24, 2014, Kana has provided the justification you are seeking to address your specific questions. Based on his input, we offer the following responses:

### Question 1: Participating Receptors

All of the participating receptors will include project infrastructure and adhere to the definition provided in O. Reg. 359/09 and include a project component.

The REA application considered 80 turbines during the project planning and design stages, including the completion of the various technical reports. The 80 turbine layout is compliant with the noise requirements of the regulation. In order to meet the FIT contract requirements of 230 MW, only 77 of these 80 turbines are to be built (each rated at 3 MW - one or more to be de-rated to satisfy the 230MW requirement).

The specific turbines to be constructed will depend on the detailed engineering and wind resourcing studies to be completed. The decision to drop a turbine depends highly on wind power, and it is likely that a turbine may be dropped from a cluster of turbines where more than one turbine is located within the same property (due to wind resources). Based on that understanding, all participating receptors will continue to fit the definition of participating receptors.

In the event that a turbine is dropped from a property with only one turbine, the design of the wind farm will ensure that project infrastructure remains on that property to ensure its compliance as a participating receptor, in the event that it violates the 40.0 dBA noise threshold, as defined in the regulation.

Question 2: Re Table 3.1 ; Sound Power Levels for the E-101

In preparing the noise model and assessment, Stantec concluded the data is valid based on the following:

- a. Stantec used sound power levels in the analysis, which is a parameter independent of height of the source;
- b. The manufacturer has guaranteed /confirmed to NRWC that their machine will meet the sound power requirements as specified in the test sheet (included with the report); and
- c. IEC 61400-11 (i.e. international standard CAN/CSA-C61400-11-07) uses normalized height so that measurements are independent of height and terrain (i.e. location, where it was measured).

As such, the manufacturer's data values used in the noise model for predicting sound power levels at the various receptors are valid for the E-101 turbines.

Question 3: Re Table 3.1 ; Sound Power Levels for the E-82

Similar to the above rationale, the manufacturer's data values used in the noise model for predicting sound power levels at the various receptors are valid for the E-82 turbines.

We trust that this information is of assistance. If you have any further questions, please do not hesitate to give Kana or myself a call.

Sincerely,

Chris

**Chris Powell, M.A.**

Project Manager, Environmental Planner  
Stantec  
49 Frederick Street Kitchener ON N2H 6M7  
Phone: (519) 585-7416  
Cell: (519) 501-2368  
Fax: (519) 579-6733  
Chris.Powell@stantec.com



The content of this email is the confidential property of Stantec and should not be copied, modified, retransmitted, or used for any purpose except with Stantec's written authorization. If you are not the intended recipient, please delete all copies and notify us immediately.

 Please consider the environment before printing this email.

---

**From:** Miller, Denton (ENE) [<mailto:Denton.Miller@ontario.ca>]  
**Sent:** Friday, January 24, 2014 3:15 PM  
**To:** Ganesh, Kana; Hung, Timothy; Raetsen, Sarah (ENE)  
**Cc:** Raetsen, Sarah (ENE); Powell, Chris; Leggett, Al  
**Subject:** RE: Niagara Region Wind Farm Information request MOE ref file # 1175-972NB9

Hello Kana

He have started review of the subject application and to date have the following preliminary questions.

**Question 1: Participating Receptors**

**Background:**

Section 1 of the report notes the following:

The facility is comprised of 80 wind turbine. However, only 77 of the wind turbines will be constructed.

Section 4.2 of the report notes the following:

There are a total of 96 Participating Receptors.

**Issue:**

Please confirm that the participating Noise Receptors adhere with the definition in Section 1(6) of O. Reg. 359/09. Specifically will all participating receptors have infrastructure located on them?

If this is not the case then some of these participating receptors must be considered as points of reception and the analysis in the report updated to address these points of reception.

---

**Question 2: Re Table 3.1 ; Sound Power Levels for the E-101**

It is noted that the data in Appendix D (Enercon E-101) is for a turbine with a hub height of **99 m**. The proposal ( Sept 30, 2013 report ) notes the turbine nacelles will be at **124 m** and/or **135 m** height. Please comment on the implication of using the 99 m data in your analysis to represent turbines at **124 m** and/or **135 m** height .

---

**Question 3: Re Table 3.1 ; Sound Power Levels for the E-82**

It is noted that the data in Appendix D (Enercon E-82) is for a turbine with a hub height of **108 m**. The proposal ( Sept 30, 2013 report ) notes the turbine nacelles will be at **135 m** height. Please comment on the implication of using the 108 m data in your analysis to represent turbines at **135 m** height .

Thank you.

*Regards*  
*Denton Miller*

Denton Miller | Senior Review Engineer | Team 5 | Environmental Approvals Branch | Ministry of the Environment  
2 St. Clair Ave W. 12a Floor Toronto, Ontario, M4V 1L5 | Phone: 416-314-8310 | [Denton.Miller@ontario.ca](mailto:Denton.Miller@ontario.ca)

---

**From:** Ganesh, Kana [<mailto:Kana.Ananthganeshan@stantec.com>]

**Sent:** January 7, 2014 4:18 PM

**To:** Miller, Denton (ENE); Hung, Timothy



**Cc:** Raetsen, Sarah (ENE); Powell, Chris; Leggett, Al

**Subject:** RE: Niagara Region Wind Farm Information request MOE ref file # 1175-972NB9

Thanks for the email Denton and happy New Year to you.

Please find attached the Tables; I have some of them in Word format (readily available) and some in Excel format.

Please let me know word format is acceptable for your purpose.

Best regards

**Kana Ganesh, PhD., P.Eng**

Sr. Acoustics Noise and Vibration Engineer

300 - 675 Cochrane Drive West Tower Markham ON L3R 0B8

Phone: 905-415-6332

Fax: 905-474-9889

kana.ganesh@stantec.com



Design with community in mind

[stantec.com](http://stantec.com)

The content of this email is the confidential property of Stantec and should not be copied, modified, retransmitted, or used for any purpose except with Stantec's written authorization. If you are not the intended recipient, please delete all copies and notify us immediately.



Please consider the environment before printing this email.

---

**From:** Miller, Denton (ENE) [<mailto:Denton.Miller@ontario.ca>]

**Sent:** Tuesday, January 07, 2014 3:27 PM

**To:** Ganesh, Kana; Hung, Timothy

**Cc:** Raetsen, Sarah (ENE); Powell, Chris

**Subject:** Niagara Region Wind Farm Information request MOE ref file # 1175-972NB9

Hello Kana / Timothy

I am the review engineer assigned to this file. To facilitate my review , please forward excel copies of the following tables in the noise assessment report.

Tables:

2.1	3.3	3.6	4.1
3.1	3.4	3.7	6.2
3.2	3.5	3.8	6.3

F.5 Appendix E

F.6 Barrier Co-ordinates

your file # 160950269 dated September 30, 2013.

Thank you

## APPLICATION SUMMARY

<b>Status</b>	<b>New Application</b>	<b>Assigned</b>	
<b>IDS Reference #</b>	<b>1175-972NB9</b>	<b>File #</b>	<b>R- 0018 -13</b>
<b>REA #</b>			
<b>Application Type</b>	<b>New Renewable Energy Approval</b>		
<b>Media</b>	<b>Noise</b>		
<b>Facility Type:</b>			
<b>Client Name</b>	<b>Niagara Region Wind Corporation</b>	<b>Client #</b>	<b>2349-972N8X</b>
<b>Client Aliases</b>			
<b>Site Name</b>	<b>Niagara Region Wind Farm</b>	<b>Site #</b>	<b>9527-972NA9</b>

Denton Miller | Senior Review Engineer | Team 5 | Environmental Approvals Branch | Ministry of the Environment  
2 St. Clair Ave W. 12a Floor Toronto, Ontario, M4V 1L5 | Phone: 416-314-8310 | [Denton.Miller@ontario.ca](mailto:Denton.Miller@ontario.ca)

**Appendix G3 – Sound Power Level Rationale**Concern:

Concerns were raised by the MOE with respect to Enercon's specification of the applicable sound power level for the E-82 and E101 turbines for this Project. Specifically, MOE requested clarification regarding the applicability of different data sheets available from Enercon noting different values for the 95% rated capacity sound power levels for the E-82 and E101 turbines.

Response:

Based on follow-up discussions with Enercon, and discussions with the MOE, a more definitive statement confirming the use of the 104.8 dBA noise data for the E101 turbines proposed for the NRWC Project has been obtained from Enercon. The following documents are attached confirming the use of the appropriate data in the NAR for this Project:

- a. Letter from Enercon entitled Sound Power Level (SPL) documents of the ENERCON Wind Energy Converters (WECs) E101 3.0MW and the E-82 2.3MW for Niagara Region Wind Corporation (NRWC) dated April 15, 2014, and corresponding attachments:
  - 1) Sound Power Level E101 NRWC dated April 15, 2014
  - 2) KÖTTER measurement excerpts dated April 23, 2013 and March 13, 2013
  - 3) Sound Power Level E-82 NRWC dated April 15, 2014
  - 4) KÖTTER measurement excerpt dated February 8, 2010

This letter provides the additional confirmation and greater certainty with respect to the sound power level information for the turbines being proposed for the NRWC Project.

As noted in the attached documents, Enercon is continuously optimizing the mechanical and aerodynamic characteristics of its turbines to reduce the overall SPL. Specific actions include the addition of dampers as well as design modifications, where possible. As such, Enercon has confirmed the validity of using the maximum sound power level 104.8 dBA for the E101 turbine and 103.3 dBA for the E-82 turbine for the NRWC facility in accordance with the attached supporting documents. See correspondence dated April 16, 2014 and April 24, 2014 (attached).

**Hassan Shahriar**  
**Commercial Manager**  
Direct Line: (416) 572-8912  
Email: [hassan.shahriar@enercon.de](mailto:hassan.shahriar@enercon.de)

April 15, 2014

By email

**Niagara Region Wind Corporation**  
**277 Lakeshore Road East, Suite 211**  
**Oakville, ON L6J 6J3**

**Attn: Mr. Mervin Croghan**

**Subject: Sound Power Level (SPL) documents of the ENERCON Wind Energy Converters (WECs) E-101 3.0MW and the E-82 2.3MW for Niagara Region Wind Corporation (NRWC).**

Dear Sir,

It is our understanding that a document titled “Sound Power Level of the E-101, Operational Mode I (Data Sheet)” has been obtained by the Ministry of Environment of Ontario. This document differs from the one ENERCON provided to NRWC for the purpose of its facility. In order to prevent any confusion, please find below clarification on the relevancy of the SPL documents provided to NRWC.

The document “Sound Power Level of the E-101, Operational Mode I (Data Sheet)” contains estimated values, which are based on the theoretical estimation of sound characteristics of turbine technology, as well as modeling of mechanical and aerodynamic properties. ENERCON is continuously optimizing the mechanical and aerodynamic characteristics of its turbines to reduce the overall SPL. Specific actions include the addition of dampers as well as design modifications, where possible. These led to improved sound characteristics which were subsequently measured by KÖTTER Consulting Engineers GmbH & Co. KG, an independent engineering firm.

KÖTTER’s measurements for the E-101 and the E-82 form the basis of the SPL documents provided to NRWC. ENERCON confirms the validity of using the maximum SPL of E-101 at 104.8 dBA and of E-82 at 103.3 dBA for the NRWC facility. As such, ENERCON confirms that the attached Sound Power Level documents (dated April 15, 2014) be used for the noise assessment of the NRWC facility.

Sincerely,

Hassan Shahriar  
Commercial Manager  
**ENERCON Canada Inc.**

cc : Darren Croghan, Michael Weidemann, Mark Smith

attached: Sound Power Level E-101 NRWC dated April 15, 2014  
KÖTTER measurement excerpts dated April 23, 2013 and March 13, 2013  
Sound Power Level E-82 NRWC dated April 15, 2014  
KÖTTER measurement excerpt dated February 8, 2010



# Sound Power Level of the ENERCON E-82 2.3 MW

**Publisher:**

ENERCON Canada Inc.  
1000, rue de La Gauchetière ouest Bureau 2310  
Montréal, QC, H3B 4W5  
+1 514 ENERCON (+1 514 363 7266)

**Copyright:**

© ENERCON Canada Inc. Any reproduction, distribution and utilisation of this document as well as the communication of its contents to third parties without express authorisation is prohibited. Violators will be held liable for monetary damages. All rights reserved in the event of the grant of a patent, utility model or design.

**Content subject to change:**

ENERCON Canada Inc. reserves the right to change, improve and expand this document and the subject matter described herein at any time without prior notice.

Author/date:	H.Shahriar /15.06.12	Translator/date:	N.Nnnn / DD.MM.YY
Department:	Sales	Revisor/date:	H.Shahriar / 11.04.14
Approved/date:	M. Weidemann/11.04.14	Reference:	Sound Power Level E-82 NRWC 140415.doc
Released/date:	H.Shahriar /15.04.14		

The following represents the sound power level of the E-82 2.3 MW for the entire operational range of wind speeds in accordance with the measurement technique IEC 61 400 – 11:2002 and A1:2006.

**Sound Power Level (SPL) for the E-82 with 2.3 MW rated power**

Vs in 10m height	Hub Height	108m	138m
<b>6 m/s</b>		<b>100.6 dB(A)</b>	<b>101.1 dB(A)</b>
<b>7 m/s</b>		<b>102.5 dB(A)</b>	<b>102.8 dB(A)</b>
<b>8 m/s</b>		<b>103.2 dB(A)</b>	<b>103.3 dB(A)</b>
<b>9 m/s</b>		<b>103.3 dB(A)</b>	<b>103.3 dB(A)</b>
<b>10 m/s</b>		<b>103.3 dB(A)</b>	<b>103.3 dB(A)</b>
<b>95% rated power</b>		<b>103.3 dB(A)</b>	<b>103.3 dB(A)</b>

Measurement results of the octave band corresponding to 95% or higher rated power are presented in the table below. ENERCON confirms the measurements values to be representative values of the E-82 2.3 MW noise levels.

Frequency (Hz)	Octave band sound power level in dB(A)								dB(A)
	63	125	250	500	1,000	2,000	4,000	8,000	
<b>E-82 2.3 MW @ 9m/s</b>	86.6	94.6	94.3	97.3	98.7	93.8	81.5	73.4	103.3

1. The relation between the sound power level and the standardized wind speed  $V_s$  in 10 m height as shown above is valid on the premise of a logarithmic wind profile with a roughness length of 0.05m. The relation between the sound power level and the wind speed at hub heights applies for all hub heights. During the sound measurements the wind speeds are derived from the power output and the power curve of the WEC.
2. A tonal audibility of  $\Delta L_{a,k} \leq 2$  dB can be expected over the whole operational range and is valid in the near vicinity of the turbine according to IEC 61 400 -11 ed. 2.

Author/date:	H.Shahriar /15.06.12	Translator/date:	N.Nnnn / DD.MM.YY
Department:	Sales	Revisor/date:	H.Shahriar / 11.04.14
Approved/date:	M. Weidemann/11.04.14	Reference:	Sound Power Level E-82 NRWC 140415.doc
Released/date:	H.Shahriar /15.04.14		

3. Sound power level values provided in the table are valid for the **Operational Mode I**. The respective power curve is the calculated power curve of the E-82 E2 dated November 2009 (Rev 3.0).
4. Due to typical measurement uncertainties, if the sound power level is measured according to the accepted method, the measured values can differ from the values shown in this document in the range of +/- 1dB.

Accepted measurement method:

IEC 61400-11 ed.2 ("Wind turbine generator systems – Part 11: Acoustic noise measurement techniques; Second edition, 2002 – 12").

If the difference between total noise and background noise during a measurement is less than 6 dB, a higher uncertainty must be considered.

5. The sound power level of a wind turbine depends on several factors such as, but not limited to, regular maintenance and day-to-day operation in compliance with the manufacturer's operating instructions.

Author/date:	H.Shahriar /15.06.12	Translator/date:	N.Nnnn / DD.MM.YY
Department:	Sales	Revisor/date:	H.Shahriar / 11.04.14
Approved/date:	M. Weidemann/11.04.14	Reference:	Sound Power Level E-82 NRWC 140415.doc
Released/date:	H.Shahriar /15.04.14		

<b>Summary of Test Report</b>												
<b>(Measured hub height of 108 m) /1/</b>												
<b>Basic sheet "Geräusche" (Noise), according to the</b>												
<b>"Technische Richtlinien für Windenergieanlagen, Teil 1: Bestimmung der Schallemissionswerte"</b>												
<b>(Technical Guidelines for Wind Energy Converters, Part 1: Determination of sound emission values)</b>												
Rev. 18 of February 1, 2008 (Editor: Fördergesellschaft Windenergie e.V. Stresemannplatz 4, D-24103 Kiel)												
Extract of Test Report 209244-04.01 IEC												
on noise emission of wind energy converter of type E-82 E2												
<b>General Data</b>						<b>Technical Data (manufacturer's specifications)</b>						
Manufacturer of WEC:		Enercon GmbH				Rated power (generator):		2.300 kW				
Serial number:		82679				Diameter of rotor:		82 m				
Location of WEC (ca.):		26629 Großefehn				Hub height above ground:		108 m				
Geographic co-ordinates:		GK longitude:		34.15.287		Type of tower:		conical tube tower				
		GK latitude:		59.14.701		Power control:		Pitch				
<b>Complementary rotor data</b>						<b>Complementary data of gear unit and generator</b>						
<b>(manufacturer's specifications)</b>						<b>(manufacturer's specifications)</b>						
Manufacturer of rotor blade:		Enercon				Manufacturer of gear unit:		not applicable				
Type of rotor blade:		E-82 E2				Type of gear unit:		not applicable				
Blade setting angle:		variable				Manufacturer of generator:		Enercon				
Number of rotor blades:		3				Type of generator:		E-82 E2				
Rotor speed range:		6 to 18 r.p.m. (mode OM I)				Generator speed range:		6 to 18 r.p.m. (mode OM I)				
Calculated Performance Chart ENERCON E-82 E2; calculated by ENERCON (Rev. 3.0)												
	<b>Reference Point</b>				<b>Noise emission parameters</b>	<b>Observations</b>						
	standardized wind speed in 10 m height		true electrical power									
sound power level $L_{WA,P}$	5 $ms^{-1}$		579 kW		96.4 dB(A)							
	6 $ms^{-1}$		1,089 kW		100.6 dB(A)							
	7 $ms^{-1}$		1,612 kW		102.5 dB(A)							
	8 $ms^{-1}$		2,032 kW		103.2 dB(A)							
	9 $ms^{-1}$		2,255 kW		103.3 dB(A)							
	10 $ms^{-1}$		2,300 kW		102.9 dB(A)							
tonal audibility $\Delta L_{a,k}$	5 $ms^{-1}$		kW		- 2.7 dB							
	6 $ms^{-1}$		kW		<- 3.0 dB							
	7 $ms^{-1}$		kW		- 1.8 dB							
	8 $ms^{-1}$		kW		- 0.7 dB							
	9 $ms^{-1}$		kW		0.2 dB							
	10 $ms^{-1}$		kW		- 0.4 dB							
impulse adjustment for small distances $K_{IN}$	5 $ms^{-1}$		kW		0 dB							
	6 $ms^{-1}$		kW		0 dB							
	7 $ms^{-1}$		kW		0 dB							
	8 $ms^{-1}$		kW		0 dB							
	9 $ms^{-1}$		kW		0 dB							
	10 $ms^{-1}$		kW		0 dB							
<b>Third-octave band sound power level</b> for $v_s = 5 ms^{-1}$ in dB(A)												
Frequency	50	63	80	100	125	160	200	250	315	400	500	630
$L_{WA,P}$	74.1	76.5*	80.0	85.6	82.2	81.7	81.9	83.7	85.6	85.1	85.5	87.6
Frequency	800	1,000	1,250	1,600	2,000	2,500	3,150	4,000	5,000	6,300	8,000	10,000
$L_{WA,P}$	86.9	86.2	84.8	82.4	78.8	75.3	70.6	65.5	60.3*	60.3*	63.0	70.3
<b>Octave band sound power level</b> for $v_s = 5 ms^{-1}$ in dB(A)												
Frequency	63		125		250		500		1,000		8,000	
$L_{WA,P}$	82.3		88.3		88.8		91.0		90.8		71.4	
<b>Third-octave band sound power level</b> for $v_s = 6 ms^{-1}$ in dB(A)												
Frequency	50	63	80	100	125	160	200	250	315	400	500	630
$L_{WA,P}$	78.2**	79.1*	82.2	85.2	87.4	84.3	85.0	87.3	88.7	88.5*	89.5*	93.2
Frequency	800	1,000	1,250	1,600	2,000	2,500	3,150	4,000	5,000	6,300	8,000	10,000
$L_{WA,P}$	91.7	91.5	89.9	87.1	83.0	79.4	74.4	69.0	63.5	64.4	67.4	74.3

Octave band sound power level for $v_s = 6 \text{ ms}^{-1}$ in dB(A)												
Frequency	63	125	250	500	1,000	2,000	4,000	8,000				
L <sub>WA,P</sub>	84.9*	90.6	92.0	95.7	95.9	89.0	75.8	75.4				
Third-octave band sound power level for $v_s = 7 \text{ ms}^{-1}$ in dB(A)												
Frequency	50	63	80	100	125	160	200	250	315	400	500	630
L <sub>WA,P</sub>	78.6**	79.8	82.7	84.8	90.8	86.2	86.0	89.7	91.0	92.5	91.7	93.9
Frequency	800	1,000	1,250	1,600	2,000	2,500	3,150	4,000	5,000	6,300	8,000	10,000
L <sub>WA,P</sub>	93.4	93.3	91.8	89.2	85.8	81.9	77.0	72.2	66.1	65.3	66.8	72.8
Octave band sound power level for $v_s = 7 \text{ ms}^{-1}$ in dB(A)												
Frequency	63	125	250	500	1,000	2,000	4,000	8,000				
L <sub>WA,P</sub>	85.5*	92.8	94.2	97.6	97.7	91.4	78.5	74.4				
Third-octave band sound power level for $v_s = 8 \text{ ms}^{-1}$ in dB(A)												
Frequency	50	63	80	100	125	160	200	250	315	400	500	630
L <sub>WA,P</sub>	77.4*	80.4	83.1	84.9	91.2	86.6	86.3	90.4	91.4	92.9	92.1*	94.8
Frequency	800	1,000	1,250	1,600	2,000	2,500	3,150	4,000	5,000	6,300	8,000	10,000
L <sub>WA,P</sub>	94.2	94.1	92.6	90.1	86.7	82.7	77.8	73.3	67.7	65.8	66.6	71.4
Octave band sound power level for $v_s = 8 \text{ ms}^{-1}$ in dB(A)												
Frequency	63	125	250	500	1,000	2,000	4,000	8,000				
L <sub>WA,P</sub>	85.6	93.2	94.6	98.2	98.5	92.2	79.4	73.4				
Third-octave band sound power level for $v_s = 9 \text{ ms}^{-1}$ in dB(A)												
Frequency	50	63	80	100	125	160	200	250	315	400	500	630
L <sub>WA,P</sub>	78.5	81.4	83.9	85.7	92.6	88.2	86.4	90.2	90.7	91.8	91.5*	93.9
Frequency	800	1,000	1,250	1,600	2,000	2,500	3,150	4,000	5,000	6,300	8,000	10,000
L <sub>WA,P</sub>	94.0	94.4	93.4	91.5	88.4	84.6	79.9	75.4	69.3	65.5*	66.4	71.5
Octave band sound power level for $v_s = 9 \text{ ms}^{-1}$ in dB(A)												
Frequency	63	125	250	500	1,000	2,000	4,000	8,000				
L <sub>WA,P</sub>	86.6	94.6	94.3	97.3*	98.7	93.8	81.5	73.4				
Third-octave band sound power level for $v_s = 10 \text{ ms}^{-1}$ in dB(A)												
Frequency	50	63	80	100	125	160	200	250	315	400	500	630
L <sub>WA,P</sub>	78.8	81.7	84.5	86.3	92.4	88.5	86.4	89.8	90.0*	91.2	90.9*	92.7*
Frequency	800	1,000	1,250	1,600	2,000	2,500	3,150	4,000	5,000	6,300	8,000	10,000
L <sub>WA,P</sub>	93.3	93.9	93.3	91.5	88.8	85.2	80.7	76.5	71.9	70.4	68.5	71.8
Octave band sound power level for $v_s = 10 \text{ ms}^{-1}$ in dB(A)												
Frequency	63	125	250	500	1,000	2,000	4,000	8,000				
L <sub>WA,P</sub>	87.0	94.6	93.7	96.5*	98.3	94.0	82.5	75.2				

This summary of the test report is valid only in combination with the certification of the manufacturer of 03/05/2010.

**These specifications do not replace the test report mentioned above (particularly for noise immission predictions).**

Observations: \* Difference between working and background noise < 6 dB, correction by 1.3 dB  
 \*\* Difference between working and background noise < 3 dB, values shall not be presented

/1/ Wind turbine generator systems – Part 11: Acoustic noise; measurement techniques (IEC 61400-11:2002 and A1:2006);  
 German version DIN EN 61400-11:2007

Measured by: KÖTTER Consulting Engineers  
 - Rheine -



Date: 08/02/2010

i. V. Dipl.-Ing. O. Bunk i. A. Dipl.-Ing. J. Weinheimer



# Sound Power Level of the ENERCON E-101 3.0 MW

**Publisher:**

ENERCON Canada Inc.  
1000, rue de La Gauchetière ouest Bureau 2310  
Montréal, QC, H3B 4W5  
+1 514 ENERCON (+1 514 363 7266)

**Copyright:**

© ENERCON Canada Inc. Any reproduction, distribution and utilisation of this document as well as the communication of its contents to third parties without express authorisation is prohibited. Violators will be held liable for monetary damages. All rights reserved in the event of the grant of a patent, utility model or design.

**Content subject to change:**

ENERCON Canada Inc. reserves the right to change, improve and expand this document and the subject matter described herein at any time without prior notice.

Author/date:	H.Shahriar /15.06.12	Translator/date:	N.Nnnn / DD.MM.YY
Department:	Sales	Revisor/date:	H.Shahriar / 11.04.14
Approved/date:	M. Weidemann/11.04.14	Reference:	Sound Power Level E-101 NRWC 140415.doc
Released/date:	H.Shahriar /15.04.14		

The following represents the sound power level of the E-101 3.0 MW for the entire operational range of wind speeds in accordance with the measurement technique IEC 61 400 – 11:2002 and A1:2006.

### Sound Power Level (SPL) for the E-101 with 3.0 MW rated power

Hub Height Vs in 10m height	99m	124m	135m
6 m/s	103.6 dB(A)	103.6 dB(A)	103.8 dB(A)
7 m/s	104.3 dB(A)	104.3 dB(A)	104.5 dB(A)
8 m/s	104.8 dB(A)	104.8 dB(A)	104.8 dB(A)
9 m/s	104.8 dB(A)	104.8 dB(A)	104.8 dB(A)
10 m/s	104.8 dB(A)	104.8 dB(A)	104.8 dB(A)
95% rated power	104.8 dB(A)	104.8 dB(A)	104.8 dB(A)

Measurement results of the octave band corresponding to 95% or higher rated power are presented in the table below. ENERCON confirms the measurements values to be representative values of the E-101 3.0 MW noise levels.

Frequency (Hz)	Octave band sound power level in dB(A)								dB(A)
	63	125	250	500	1,000	2,000	4,000	8,000	
<b>E-101 3.0 MW @ 8.3m/s</b>	86.3	91.6	98.6	100.8	98.3	92.8	85.9	73.3	104.8

1. The relation between the sound power level and the standardized wind speed  $V_s$  in 10 m height as shown above is valid on the premise of a logarithmic wind profile with a roughness length of 0.05m. The relation between the sound power level and the wind speed at hub heights applies for all hub heights. During the sound measurements the wind speeds are derived from the power output and the power curve of the WEC.
2. A tonal audibility of  $\Delta L_{a,k} \leq 2$  dB can be expected over the whole operational range and is valid in the near vicinity of the turbine according to IEC 61 400 -11 ed. 2.

Author/date:	H.Shahriar /15.06.12	Translator/date:	N.Nnnn / DD.MM.YY
Department:	Sales	Revisor/date:	H.Shahriar / 11.04.14
Approved/date:	M. Weidemann/11.04.14	Reference:	Sound Power Level E-101 NRWC 140415.doc
Released/date:	H.Shahriar /15.04.14		

3. Sound power level values provided in the table are valid for the **Operational Mode I**. The respective power curve is the calculated power curve of the E-101 dated October 2009 (Rev 2.0).
4. Due to typical measurement uncertainties, if the sound power level is measured according to the accepted method, the measured values can differ from the values shown in this document in the range of +/- 1dB.

Accepted measurement method:

IEC 61400-11 ed.2 ("Wind turbine generator systems – Part 11: Acoustic noise measurement techniques; Second edition, 2002 – 12").

If the difference between total noise and background noise during a measurement is less than 6 dB, a higher uncertainty must be considered.

5. The sound power level of a wind turbine depends on several factors such as, but not limited to, regular maintenance and day-to-day operation in compliance with the manufacturer's operating instructions.

Author/date:	H.Shahriar /15.06.12	Translator/date:	N.Nnnn / DD.MM.YY
Department:	Sales	Revisor/date:	H.Shahriar / 11.04.14
Approved/date:	M. Weidemann/11.04.14	Reference:	Sound Power Level E-101 NRWC 140415.doc
Released/date:	H.Shahriar /15.04.14		

## Summary of Test Report (Measured hub height of 99 m) /1/

Master Data Sheet "Geräusche" (Noise), in accordance with  
 "Technische Richtlinien für Windenergieanlagen, Teil 1: Bestimmung der Schallemissionswerte"  
 (Technical Guidelines for Wind Turbine Generators, Part 1: Determination of sound emission values)

Rev. 18 of February 1, 2008 (Editor: Fördergesellschaft Windenergie e.V. Stresemannplatz 4, D-24103 Kiel)

Extract of Test Report 213122-02.01 IEC  
 on noise emission of wind turbine generator of type E-101

General Data		Technical Data (manufacturer's specifications)	
Manufacturer of WTG:	Enercon GmbH	Rated power (generator):	3,050 (3,250) kW
Serial number:	1010002	Diameter of rotor:	101 m
Location of WTG (approx.):	49733 Haren	Hub height above ground:	99 m
Geographic co-ordinates:	GK longitude: 25.76.214 GK latitude: 58.59.856	Type of tower:	conical tubular concrete
		Power control:	Pitch
Complementary rotor data (manufacturer's specifications)		Complementary data of gear unit and generator (manufacturer's specifications)	
Manufacturer of rotor blade:	Enercon	Manufacturer of gear unit:	not applicable
Type of rotor blade:	E-101-1	Type of gear unit:	not applicable
Blade setting angle:	variable	Manufacturer of generator:	Enercon
Number of rotor blades:	3	Type of generator:	G-101/30-G2
Rotor speed range:	5 to 14.7 rpm. (mode OM I)	Rated speed of generator:	5 to 14.7 rpm. (mode OM I)

Calculated Performance Chart: Performance characteristic E101 3 MW OM I ; calculated by ENERCON (Rev. 1.0)

	Reference Point		Noise emission parameters	Observations
	standardized wind speed at a height of 10 m	true electrical power		
sound power level $L_{WA,P}$	6 $ms^{-1}$	1,414 kW	103.6 dB(A)	
	7 $ms^{-1}$	2,077 kW	104.3 dB(A)	
	8 $ms^{-1}$	2,751 kW	104.8 dB(A)	
	9 $ms^{-1}$	2,987 kW	104.6 dB(A)	(1)
	10 $ms^{-1}$	3,050 kW	--	(2)
tonal audibility $\Delta L_{a,k}$	6 $ms^{-1}$	1,414 kW	- 1.5 dB	
	7 $ms^{-1}$	2,077 kW	0 dB	
	8 $ms^{-1}$	2,751 kW	0 dB	
	9 $ms^{-1}$	2,987 kW	0 dB	(1)
	10 $ms^{-1}$	3,050 kW	--	(2)
impulse adjustment for immediate vicinity $K_{IN}$	6 $ms^{-1}$	1,414 kW	0 dB	
	7 $ms^{-1}$	2,077 kW	0 dB	
	8 $ms^{-1}$	2,751 kW	0 dB	
	9 $ms^{-1}$	2,987 kW	0 dB	(1)
	10 $ms^{-1}$	3,050 kW	--	(2)

Third-octave band sound power level for $v_s = 6 ms^{-1}$ in dB(A)												
Frequency	50	63	80	100	125	160	200	250	315	400	500	630
$L_{WA,P}$	78.3	81.8*	83.0**	84.2	89.6	85.7*	89.2	92.7	94.1	94.6	95.1	94.9
Frequency	800	1,000	1,250	1,600	2,000	2,500	3,150	4,000	5,000	6,300	8,000	10,000
$L_{WA,P}$	93.5	91.6	90.0	89.0	85.4	84.1	82.3	79.3	74.8	67.8*	64.7**	65.3**

Octave band sound power level for $v_s = 6 ms^{-1}$ in dB(A)								
Frequency	63	125	250	500	1,000	2,000	4,000	8,000
$L_{WA,P}$	85.6*	91.9	97.2	99.6	96.7	91.5	84.6	70.3*

Third-octave band sound power level for $v_s = 7 ms^{-1}$ in dB(A)												
Frequency	50	63	80	100	125	160	200	250	315	400	500	630
$L_{WA,P}$	78.9	83.3	84.0	84.9	88.2	86.4*	89.6	94.7	94.9	95.4	95.8	95.5
Frequency	800	1,000	1,250	1,600	2,000	2,500	3,150	4,000	5,000	6,300	8,000	10,000
$L_{WA,P}$	94.0	92.0	90.4	89.3	86.1	84.7	82.9	79.9	74.4*	68.4*	64.6**	62.7**

Octave band sound power level for $v_s = 7 ms^{-1}$ in dB(A)								
Frequency	63	125	250	500	1,000	2,000	4,000	8,000
$L_{WA,P}$	87.3	91.5	98.4	100.3	97.1	91.9	85.0	71.5**

Third-octave band sound power level for $v_s = 8 \text{ ms}^{-1}$ in dB(A)												
Frequency	50	63	80	100	125	160	200	250	315	400	500	630
L <sub>WAP</sub>	82.1	82.8	84.4	88.4	86.8	90.1	94.8	95.0	95.6	96.3	96.2	82.1
Frequency	800	1,000	1,250	1,600	2,000	2,500	3,150	4,000	5,000	6,300	8,000	10,000
L <sub>WAP</sub>	95.0	93.3	91.5	90.4	86.7	85.4	83.7	80.9	75.9	69.7*	67.1**	65.5**
Octave band sound power level for $v_s = 8 \text{ ms}^{-1}$ in dB(A)												
Frequency	63	125	250	500	1,000	2,000	4,000	8,000				
L <sub>WAP</sub>	86.3	91.6	98.6	100.8	98.3	92.8	86.0	73.3**				
Third-octave band sound power level for $v_s = 9 \text{ ms}^{-1}$ in dB(A)												
Frequency	50	63	80	100	125	160	200	250	315	400	500	630
L <sub>WAP</sub>	78.6	81.9	82.4*	83.9	87.8	85.9*	88.6	93.8	94.2	95.1	96.0	96.3
Frequency	800	1,000	1,250	1,600	2,000	2,500	3,150	4,000	5,000	6,300	8,000	10,000
L <sub>WAP</sub>	95.4	93.8	92.3	91.0	87.4	86.0	84.1	81.1	76.7	71.7	68.4	66.8*
Octave band sound power level for $v_s = 9 \text{ ms}^{-1}$ in dB(A)												
Frequency	63	125	250	500	1,000	2,000	4,000	8,000				
L <sub>WAP</sub>	86.0	90.8	97.6	100.6	98.8	93.5	86.4	74.2				

This summary of the test report is valid only in combination with the manufacturer's certificate dated 12/03/2013.

**These specifications do not replace the test report mentioned above (particularly for noise immission predictions).**

- Observations:
- (1) Maximum value of standardized wind speed during the WTG-operation measurement  $v_s = 8,9 \text{ m/s}$
  - (2) Due to weather conditions, no data available during WTG operation
- \* Difference between working and background noise < 6 dB, correction by 1.3 dB  
 \*\* Difference between working and background noise < 3 dB, values shall not be presented

/1/ Wind turbine generator systems – Part 11: Acoustic noise; measurement techniques (IEC 61400-11:2002 and A1:2006); German version DIN EN 61400-11:2007

Measured by: KÖTTER Consulting Engineers  
- Rheine -



Dipl.-Ing. Oliver Bunk



Matthias Humpohl, B.Sc.

Date: 23/04/2013



### Vorläufiger Auszug aus dem Prüfbericht

Stamblatt "Geräusche", entsprechend den "Technischen Richtlinien für Windenergieanlagen, Teil 1: Bestimmung der Schallemissionswerte"

Rev. 18 vom 01. Februar 2008 (Herausgeber: Forstgesellschaft Windenergie e.V. Siresemanplatz 4, D-24103 Kiel)

Auszug aus dem Prüfbericht 213121-01.01 zur Schallemission einer Windenergieanlage vom Typ E-101												
Allgemeine Angaben		Technische Daten (Herstellerangaben)										
Anlagenhersteller	Enercon GmbH	Nennleistung (Generator):	3,0 (3,25) MW									
Seriennummer:	1010002	Rotordurchmesser:	101 m									
WEA-Standort (ca.):	49733 Haren	Nabenhöhe über Grund:	99 m									
Standortkoordinaten:	RW: 25.76.214 HW: 58.59.856	Turmbauart:	Beton									
		Leistungsregelung:	Pitch									
Ergänzende Daten zum Rotor (Herstellerangaben)		Ergänzende Daten zu Getriebe und Generator (Herstellerangaben)										
Rotorblatthersteller	Enercon	Getriebehersteller	entfällt									
Typenbezeichnung Blatt:	E-101-1	Typenbezeichnung Getriebe:	entfällt									
Blatteinstellwinkel:	variabel	Generatorhersteller	Enercon									
Rotorblattanzahl:	3	Typenbezeichnung Generator:	G-101/30-G2									
Rotordrehzahlbereich:	5 - 14,7 U/min	Generatormendrehzahl:	14,7 U/min									
Leistungskurve: Leistungskennlinie E101 3 MW OM I (berechnet) der Enercon GmbH zur E-101 vom 05.07.2012												
	Referenzpunkt		Schallemissions-Parameter	Bemerkungen								
	Normierte Windgeschwindigkeit in 10 m Höhe	Elektrische Wirkleistung										
Schalleistungs-Pegel L <sub>WA,P</sub>	6 ms <sup>-1</sup>	1.414 kW	103,6 dB(A)									
	7 ms <sup>-1</sup>	2.077 kW	104,3 dB(A)									
	8 ms <sup>-1</sup>	2.751 kW	104,7 dB(A)									
	9 ms <sup>-1</sup>	2.987 kW	104,6 dB(A)									
	10 ms <sup>-1</sup>	3.050 kW	-- dB(A)	(2)								
	8,3 ms <sup>-1</sup>	2.850 kW	104,8 dB(A)	(1)								
Tonzuschlag für den Nahbereich K <sub>TN</sub>	6 ms <sup>-1</sup>	1.414 kW	0 dB bei 116 Hz									
	7 ms <sup>-1</sup>	2.077 kW	0 dB									
	8 ms <sup>-1</sup>	2.751 kW	0 dB									
	9 ms <sup>-1</sup>	2.987 kW	0 dB									
	10 ms <sup>-1</sup>	3.050 kW	-- dB	(2)								
	8,3 ms <sup>-1</sup>	2.850 kW	0 dB	(1)								
Impulszuschlag für den Nahbereich K <sub>IN</sub>	6 ms <sup>-1</sup>	1.414 kW	0 dB									
	7 ms <sup>-1</sup>	2.077 kW	0 dB									
	8 ms <sup>-1</sup>	2.751 kW	0 dB									
	9 ms <sup>-1</sup>	2.987 kW	0 dB									
	10 ms <sup>-1</sup>	3.050 kW	-- dB	(2)								
	8,3 ms <sup>-1</sup>	2.850 kW	0 dB	(1)								
<b>Terz-Schalleistungspegel</b> für v <sub>s</sub> = 8,3 ms <sup>-1</sup> in dB(A) entsprechend dem maximalen Schalleistungspegel												
Frequenz	50	63	80	100	125	160	200	250	315	400	500	630
L <sub>WA,P,max</sub>	78,8	82,1	82,7	84,4	88,4	86,7	90,0	94,8	95,0	95,6	96,3	96,2
Frequenz	800	1.000	1.250	1.600	2.000	2.500	3.150	4.000	5.000	6.300	8.000	10.000
L <sub>WA,P,max</sub>	95,0	93,3	91,5	90,4	86,6	85,4	83,7	80,8	75,8	69,7*	67,1**	65,5**
<b>Okta-Schalleistungspegel</b> für v <sub>s</sub> = 8,3 ms <sup>-1</sup> in dB(A) entsprechend dem maximalen Schalleistungspegel												
Frequenz	63	125	250	500	1.000	2.000	4.000	8.000				
L <sub>WA,P,max</sub>	86,3	91,6	98,6	100,8	98,3	92,8	85,9	73,3**				

Dieser Auszug aus dem Prüfbericht gilt nur in Verbindung mit der Herstellerbescheinigung vom 13.03.2013.

Die Angaben ersetzen nicht den o. g. Prüfbericht (insbesondere bei Schallimmissionsprognosen).

- Bemerkungen:
- (1) Die normierte Windgeschwindigkeit von v<sub>s</sub> = 8,3 ms<sup>-1</sup> entspricht 95 % der Nennleistung.
  - (2) Witterungsbedingt keine Daten vorhanden
  - \* Abstand zwischen Anlagengeräusch und Fremdgeräusch < 6 dB, Pegelkorrektur um 1,3 dB
  - \*\* Abstand zwischen Anlagengeräusch und Fremdgeräusch < 3 dB, keine Pegelkorrektur

Gemessen durch: KÖTTER Consulting Engineers GmbH & Co. KG

Datum: 13.01.2013

i. V. Dipl.-Ing. Oliver Bunk

i. A. Matthias Humpohl, B. Sc.

## Powell, Chris

---

**From:** Miller, Denton (ENE) <Denton.Miller@ontario.ca>  
**Sent:** Thursday, April 24, 2014 12:03 PM  
**To:** Powell, Chris; Raetsen, Sarah (ENE)  
**Cc:** Darren Croghan; Merv Croghan; Shiloh Berriman (sberriman@nrwc.ca); Leggett, Al; Ganesh, Kana; Hung, Timothy  
**Subject:** RE: NRWC Info Request - 2e , 8 and 9 MOE ref file # 1175-972NB9

Chris

Yes, the information provided previously has addressed our concerns.

Thank you

*Regards*  
*Denton Miller*  
*416-314-8310*

---

**From:** Powell, Chris [mailto:Chris.Powell@stantec.com]  
**Sent:** April 24, 2014 12:00 PM  
**To:** Miller, Denton (ENE); Raetsen, Sarah (ENE)  
**Cc:** Darren Croghan; Merv Croghan; Shiloh Berriman (sberriman@nrwc.ca); Leggett, Al; Ganesh, Kana; Hung, Timothy  
**Subject:** RE: NRWC Info Request - 2e , 8 and 9 MOE ref file # 1175-972NB9

Denton,

Thank you for the comments and we trust the information we provided satisfies your concerns. We will work to get the report updated as soon as possible to provide to you on or before May 9, 2014.

Sincerely,

Chris

---

**From:** Miller, Denton (ENE) [mailto:Denton.Miller@ontario.ca]  
**Sent:** Thursday, April 24, 2014 11:56 AM  
**To:** Powell, Chris; Raetsen, Sarah (ENE)  
**Cc:** Darren Croghan; Merv Croghan; Shiloh Berriman (sberriman@nrwc.ca); Leggett, Al; Ganesh, Kana; Hung, Timothy  
**Subject:** RE: NRWC Info Request - 2e , 8 and 9 MOE ref file # 1175-972NB9

Hello Chris

Thank you for your response.

Moving forward please update the noise report as noted below:

### 1. Info request 2: Sound Power Levels

- Include the turbine data sheets provided by Enercon , that address the E-101 and E-82 turbines specifications ( April 16,2014 email)

2. Add an appendix to the report that summarize :

**i) Info request 3: Eric Gillespie Letters**

- summarize the efforts made to date to address the concerns raised by Eric Gillespie (include your Jan 31, 2014 letter)

**ii) Info request 4: Receptor 1750**

- summarize the issues associated with receptor 1750. Also note the resolution. ( your Feb 12, 2014 e-mail)
- Also update the noise report accordingly (vacant lot changed to existing lot)

**iii) Info request 5: Receptor 3583**

- summarize the issues associated with receptor 3583. ( your Feb 13, 2014 and April 17 , 2014 e-mails)

**iv) Info request 6: Receptors 735,794, 1762, 582, 674, 148**

- summarize the issues associated with the receptors identified above ( your Mar 6, 2014 e-mail)
- Also update the noise report accordingly (vacant lots changed to existing lot)
- Include the new point of reception, that is in close proximity to O\_1958, in the POR Results Summary Table ( Appendix C)

**v) Info request 7: Alleged receptor between receptors 1481 and 1598**

- summarize the issues associated with the receptors identified above ( your Mar 13, 2014 e-mail)

**vi) Info request 8: Munich Higher Regional Court's decision**

- summarize the issues and Enercon's opinion associated with the Munich Higher Regional Court's decision ( your April 16, 2014 e-mail)

**vii) Info request 9: Rosa Flora Turbine**

- summarize the issues associated with the assessment of the turbine and provide the updated Cadna files ( your April 16, 2014 e-mail)

**viii) Info request 2: Sound Power Levels**

- summarize the issues associated with the different sound power level datasheets for the subject turbines ( your April 16, 2014 e-mail)

3. Please submit a signed hard copy of the report and a PDF version of the report. (Please also provide a word document with the track changes noted for the first seven sections of the report.)

4. Please submit the updated report by **May 9, 2014**.

*Regards*  
*Denton Miller*  
*416-314-8310*

---

**From:** Powell, Chris [<mailto:Chris.Powell@stantec.com>]  
**Sent:** April 16, 2014 9:46 AM  
**To:** Miller, Denton (ENE); Raetsen, Sarah (ENE)  
**Cc:** Darren Croghan; Merv Croghan; Shiloh Berriman ([sberriman@nrwc.ca](mailto:sberriman@nrwc.ca)); Leggett, Al; Ganesh, Kana; Hung, Timothy; [Hassan.Shahriar@enercon.de](mailto:Hassan.Shahriar@enercon.de)  
**Subject:** FW: Niagara Region Wind Farm Info Request - 2e , 8 and 9 MOE ref file # 1175-972NB9  
**Importance:** High

Denton,

In response to your email dated April 3, 2014, and further to our conference calls over this past week, we provide the following information to address your comments:

1. Info Request 2e - Sound Power Levels of the Subject Turbines

Based on follow-up discussions with Enercon, a more definitive statement confirming the use of the 104.8 dBA noise data for the E101 turbines proposed for the NRWC Project has been obtained from Enercon. Attached to this email are the following documents confirming the use of the appropriate data in the noise assessment report for this Project:

a. Letter from Enercon entitled *Sound Power Level (SPL) documents of the ENERCON Wind Energy Converters (WECs) E-101 3.0MW and the E-82 2.3MW for Niagara Region Wind Corporation (NRWC)* dated April 15, 2014, and corresponding attachments.

- 1) Sound Power Level E-101 NRWC dated April 15, 2014
- 2) KÖTTER measurement excerpts dated April 23, 2013 and March 13, 2013
- 3) Sound Power Level E-82 NRWC dated April 15, 2014
- 4) KÖTTER measurement excerpt dated February 8, 2010

This letter provides the additional confirmation requested in your last email and greater certainty with respect to the sound power level information for the turbines being proposed for the NRWC Project.

2. Info Request 8 – Munich Higher Regional Court's Decision pertinent to impulsive sound from Enercon E-82 wind turbines

The following comments have been provided by Enercon in response to MOE's request for information on this issue:

*The article referenced is in regard to a claim and subsequent ruling which has been made against ENERCON regarding the impulsivity of E-82 turbines in one of its wind parks near Munich, Germany.*

*ENERCON is in full disagreement with the ruling and are launching a full appeal against the region. In response, as per the official comments from ENERCON GmbH made on this issue.*

*"for us, this ruling is completely incomprehensible", says Felix Rehwald, Spokesperson for Europe's largest wind turbine manufacturer Enercon.*

*He continues to comment that ENERCON manufactures, sells and guarantees its turbines worldwide against tonality (in accordance with the IEC standards) and furthermore that Enercon's own specialists in sound power*

*have yet to yield any measurements which would indicate impulsivity of the turbines and as such, Enercon is launching counter-proceedings in the way of an appeal against the ruling.*

*The court case in Germany is not related to the NRWC project from a technical and environmental permitting perspective.*

3. Info Request 9 – Cadna files for Existing Rosa Flora Turbine

In regards to the questions raised pertaining to the Cadna files, we will circulate the correct Cadna files to the MOE under a separate email, which will be available via an FTP site for your review. The Cadna file will illustrate the correct sound power level (103.5 dBA) for the Rosa Flora Turbine, as it was used in the noise model to generate the results in the Noise Assessment Report dated September 2013.

The Cadna file previously provided on March 17, 2014 identifying a sound power level for this turbine of 101 dBA (correction factor of -2.5 dBA) was not used in the modelling exercise for this Project.

The Rosa Flora turbine is a 0.65 MW turbine located approximately 3,500 m from the nearest NRWC turbine. As per the Noise Assessment Report, the maximum sound power level for this turbine used in the model was 103.5 dBA (Section 3.3, page 3.9), which was rounded to 104 in Table 3.8. This is further confirmed in the sample calculation and Cadna/A input/outputs table provided in Appendix E and in the adjusted emission level for the Rosa Flora turbine identified in Table F1 of Appendix F of the Noise Assessment Report (Stantec, September 2014).

Based on the above, we trust that the above information is sufficient to address MOE's concerns as expressed in your email dated April 3, 2014.

If you have any questions, please do not hesitate to call.

Sincerely,

Chris

**Chris Powell, M.A.**

Project Manager, Environmental Planner  
Stantec  
49 Frederick Street Kitchener ON N2H 6M7  
Phone: (519) 585-7416  
Cell: (519) 501-2368  
Fax: (519) 579-6733  
Chris.Powell@stantec.com



The content of this email is the confidential property of Stantec and should not be copied, modified, retransmitted, or used for any purpose except with Stantec's written authorization. If you are not the intended recipient, please delete all copies and notify us immediately.

Please consider the environment before printing this email.

---

**From:** Miller, Denton (ENE) [<mailto:Denton.Miller@ontario.ca>]  
**Sent:** Thursday, April 03, 2014 1:40 PM  
**To:** Kossowski, Julia  
**Cc:** Raetsen, Sarah (ENE); Powell, Chris; Ganesh, Kana; Leggett, Al; [darrenc@nrwc.ca](mailto:darrenc@nrwc.ca); Shiloh Berriman; [mervcroghan@nrwc.ca](mailto:mervcroghan@nrwc.ca); Hung, Timothy  
**Subject:** FW: Niagara Region Wind Farm Info Request - 2e , 8 and 9 MOE ref file # 1175-972NB9

Hi Chris / Julia



Below are:

1. Additional comments to info request 2 ( Sound Power Levels of the subject turbines) ,
2. Two new information requests ( 8 & 9), and
3. A summary of the information requests to date ( attached).

---

### 1. Additional comments to Info Request 2

With respect to Enercon's attached document, I still have concerns with their specification of the applicable sound power level {RE: Section 6.2.2. of Noise Guidelines for Wind Farms}.

Specifically the use of the word suggests is problematic. ( reference copied below) .

The 104.8 dBA as presented in the Kotter document dated April 23, 2013 coincides with the Sound Power Level guarantee (95% rated power or higher) provided by ENERCON to the Niagara Region Wind Corporation. As such, ENERCON suggests that this document is more applicable to the Niagara Region Wind Corporation facility as opposed to the estimated 106 dBA presented in the ENERCON document.

Consequently, in the absence of a definitive statement from Enercon , I will be contacting you next week to discuss how my review will address this issue.

---

### 2. Info Request 8

Please ask Enercon to comment on the following court decision identified via an EBR comment:

*The Munich Higher Regional Court's decision pertinent to impulsive sound from Enercon E-82 wind turbines in a wind farm located in Rennertshofen in the district of Neuburg-Schrobenhausen. Judgment OLG München 14.08.2012*

Specifically;

1. What was the issue?
2. What was the outcome? and
3. How is this issue related to the turbines proposed in the NRWC

Please provide comments by April 17, 2014.

---

### 3. Info Request 9:

The Cadna files note the following sound power level (101.0 dBA) for Rosa Flora Turbine:

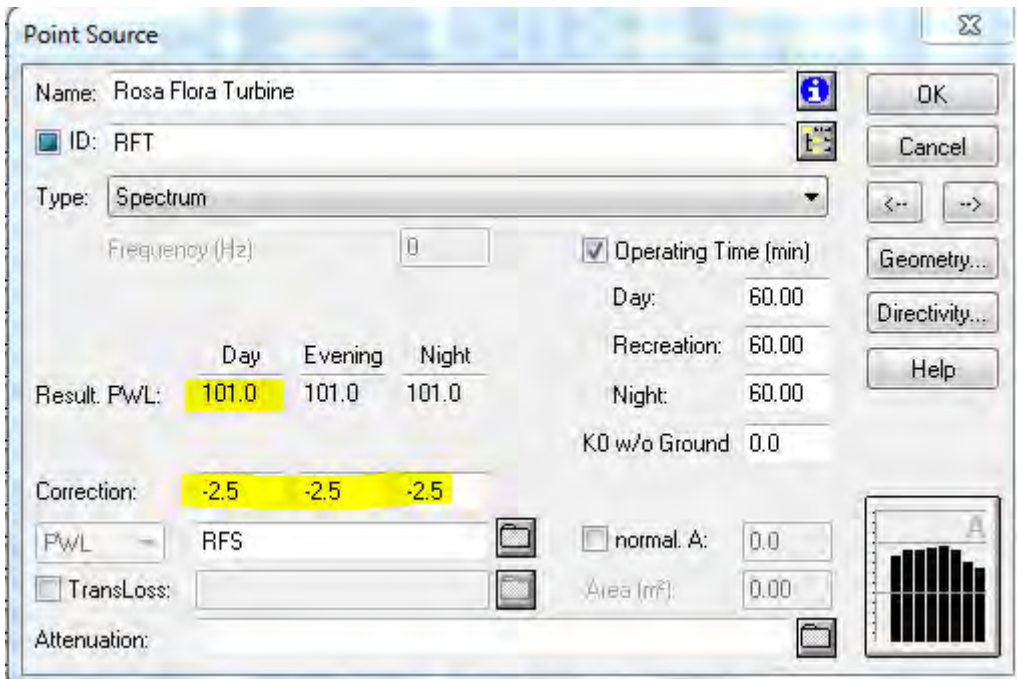

The Noise Report notes the following sound power level (104 dBA) for the same turbine .

**Table 3.8 Assessed Noise Sources Associated with Adjacent or Proposed Wind Farms within 5 km**

Source ID	Source Description	Sound Power Level [dBA]	UTM Coordinates		
			X [m]	Y [m]	Z [m]
RF	Rosa Flora Turbine	104	615270	4756417	75

Please comment on the oversight between both sources of data, and the potential impact on the calculated sound pressure levels.

Please provide comments by April 17, 2014.

*Regards*  
*Denton Miller*  
 416-314-8310

---

**From:** Kossowski, Julia [<mailto:Julia.Kossowski@stantec.com>]  
**Sent:** March 25, 2014 4:35 PM  
**To:** Miller, Denton (ENE)  
**Cc:** Raetsen, Sarah (ENE); Powell, Chris; Ganesh, Kana; Leggett, Al; [darrenc@nrwc.ca](mailto:darrenc@nrwc.ca); Shiloh Berriman ([sberriman@nrwc.ca](mailto:sberriman@nrwc.ca)); [mervcroghan@nrwc.ca](mailto:mervcroghan@nrwc.ca); Hung, Timothy  
**Subject:** FW: Niagara Region Wind Farm Info Request -2e MOE ref file # 1175-972NB9

Hello Denton,

On behalf of Chris Powell and NRWC, please find attached ENERCON's request to your email below dated March 17, 2014.

Please contact us if you require additional information.

Kind Regards,  
Julia

**Julia Kossowski, P. Eng.**  
Project Manager - Power  
Stantec  
49 Frederick Street  
Kitchener ON N2H 6M7  
Ph: (519) 569-4338  
Fx: (519) 579-4239  
Cell: (226) 989-5259  
[julia.kossowski@stantec.com](mailto:julia.kossowski@stantec.com)

The content of this email is the confidential property of Stantec and should not be copied, modified, retransmitted, or used for any purpose except with Stantec's written authorization. If you are not the intended recipient, please delete all copies and notify us immediately.

---

**From:** Miller, Denton (ENE) [<mailto:Denton.Miller@ontario.ca>]  
**Sent:** Monday, March 17, 2014 02:37 PM  
**To:** Powell, Chris; Raetsen, Sarah (ENE) <[Sarah.Raetsen@ontario.ca](mailto:Sarah.Raetsen@ontario.ca)>; Hung, Timothy  
**Cc:** Ganesh, Kana; Leggett, Al; 'darrenc@nrwc.ca' <[darrenc@nrwc.ca](mailto:darrenc@nrwc.ca)>; 'sberriman@nrwc.ca' <[sberriman@nrwc.ca](mailto:sberriman@nrwc.ca)>; 'mervcroghan@nrwc.ca' <[mervcroghan@nrwc.ca](mailto:mervcroghan@nrwc.ca)>  
**Subject:** RE: Niagara Region Wind Farm Info Request -2e MOE ref file # 1175-972NB9

Thank you for your response Chris.

**Summary :**

ENERCON considers the measurements values to be satisfactory representative values of the E-101 3,050 kW and E-82 E2 2,300 kW noise levels.

Frequency (Hz)	Octave band sound power level in dB(A)							
	63	125	250	500	1,000	2,000	4,000	8,000
E-101 3,050 kW @ 8.3m/s	86.3	91.6	98.6	100.8	98.3	92.8	85.9	73.3
E-82 E2 2,300 kW @ 9 m/s	86.6	94.6	94.3	97.3	98.7	93.8	81.5	73.4

**ISSUE:**

Unfortunately the response from Enercon (satisfactory representative) is not definitive enough for our review purposes. It is requested that Enercon explain why they have published at least two different data sheets for the

same equipment ( E-101), that have different values for the 95% rated capacity sound power levels (106 dBA and 104.8 dBA)?

It is also requested that Enercon explain why the above sound power levels for the E-101 are applicable to the Niagara Region Wind Corporation facility as opposed to the 106 dBA data that was referenced in a previous e-mail ?

Please provide a response by **March 25, 2014**.

*Regards*  
*Denton Miller*  
*416-314-8310*

---

**From:** Powell, Chris [<mailto:Chris.Powell@stantec.com>]  
**Sent:** March 17, 2014 1:25 PM  
**To:** Miller, Denton (ENE); Raetsen, Sarah (ENE); Hung, Timothy  
**Cc:** Ganesh, Kana; Leggett, Al; 'darrenc@nrwc.ca'; 'sberriman@nrwc.ca'; 'mervcroghan@nrwc.ca'  
**Subject:** RE: Niagara Region Wind Farm Info Request -2d MOE ref file # 1175-972NB9

Denton,

The attached information has been provided by Enercon in response to your email dated March 12, 2014. The values contained in the attachment provide the A-weighted values for the E-101 and E-82 turbines to 95% rated capacity, while the values included in Table 3.2 of the Noise Assessment Report (as attached to your email) are linear weighted values. The A-weighted values provided by Enercon in the attached table are consistent with the information provided previously by Enercon to Stantec for use in the noise model. These values were converted to linear weighted values following standard conversion methods and incorporated accordingly into the noise model and Noise Assessment Report.

In regards to your second comment, the requested Cadna-A file has been provided under a separate email earlier today for your review.

We trust that this information will be sufficient. If you have any further questions, please do not hesitate to ask.

Sincerely,

Chris

**Chris Powell, M.A.**  
Project Manager, Environmental Planner  
Associate, Environmental Services  
Stantec Consulting Ltd.

Office: (519) 585-7416  
Cell: (519) 501-2368  
[chris.powell@stantec.com](mailto:chris.powell@stantec.com)

---

**From:** Miller, Denton (ENE) [[Denton.Miller@ontario.ca](mailto:Denton.Miller@ontario.ca)]  
**Sent:** March 12, 2014 12:22 PM  
**To:** Powell, Chris; Raetsen, Sarah (ENE); Hung, Timothy  
**Cc:** Ganesh, Kana; Leggett, Al; 'darrenc@nrwc.ca'; 'sberriman@nrwc.ca'; 'mervcroghan@nrwc.ca'  
**Subject:** RE: Niagara Region Wind Farm Info Request -2d MOE ref file # 1175-972NB9

Thank you for your response Chris

**Summary:**

In accordance with Section 6.2.2 of the Noise Guidelines for Wind Farms your firm was requested to provide the sound power levels, frequency spectra in octave bands (63 to 8000 Hz), and tonality at integer wind speeds from 6 to 10 m/s for the subject wind turbines. ( E-82 & E-101)

Your firm responded (para-phrased) that this information is not necessary, as your analysis based on the 95% rated capacity sound power levels of the turbines. (This approach is acceptable to MOE.)

Enercon further notes (Mar 7, 2014 e-mail) that the SPL of the E-82 and the E-101 Wind Energy Converters (WECs) do not exceed beyond the values at 95% rated capacity for hub heights specified in its [Sound Power Level documents](#).

**Issue:**

There are several different Enercon documents noting different values for the 95% rated capacity sound power levels. For example:

1. There is a April 2013 Enercon document (attached) noting that the 95% rated capacity sound power level for the E-101 3050 kW turbine is **106 dBA**. ( NRWC report states this value to be **104.8 dBA**) {it is acknowledged that the ratings differ by 50 kW, Niagara turbines are smaller}
2. There is a April 2010 Enercon document (attached) noting that the 95% rated capacity sound power level for the E-82 2000 kW turbine is 103.5 dBA; (NRWC report states this value to be 103.3 dBA) {it is acknowledged that the ratings differ by 300 kW – Niagara turbines are larger}

**Requests:**

1. Please provide by **March 20, 2014**, a written statement from Enercon confirming that the values noted in Table 3.2 of your Report ( Sept 30, 2013) are accurate. (For reference the table is copied below.)

**Table 3.2 Highest Wind Turbine Sound Emission Corresponding to 95% or above Rated Electrical Output Power**

Description	Octave Band Sound Power Level (dB ref. 10-12 Watts)								dB/dBA
	63	125	250	500	1k	2k	4k	8k	
ENERCON model E101 model at 8.3 m/s	112.5	107.7	107.2	104.0	98.3	91.6	85	74.4	113.9/ 104.8
ENERCON model E82 model at 9 m/s	112.8	110.8	103	100.5	98.7	92.6	80.5	74.5	115.5/ 103.3

2. Please also forward the cadna A file (s) to this office.

*Regards*  
*Denton Miller*  
*416-314-8310*



---

**From:** Powell, Chris [<mailto:Chris.Powell@stantec.com>]

**Sent:** March 7, 2014 4:17 PM

**To:** Miller, Denton (ENE); Raetsen, Sarah (ENE); Hung, Timothy

**Cc:** Ganesh, Kana; Leggett, Al; 'darrenc@nrwc.ca'; 'sberriman@nrwc.ca'; 'mervcroghan@nrwc.ca'

**Subject:** RE: Niagara Region Wind Farm Info Request -2c MOE ref file # 1175-972NB9

Denton,

In preparing the Noise Assessment Report, Stantec and NRWC understood this issue and the requirements outlined in the MOE Noise Guidelines for Wind Farms. This issue was raised by NRWC and discussed during the project design stage with the manufacturer, who confirmed that despite the change in power with wind speed and height their guaranteed maximum sound power at rated capacity would not change for the proposed turbine models, and that tonality would not result at these higher turbine heights or wind speeds. This was confirmed and guaranteed through a separate letter from Enercon, which has been provided to the MOE as part of the Noise Assessment Report.

Following your email, we have discussed this further with Enercon and they have prepared additional information to address your specific comment with respect to hub height and tonality (see attached). In the supplemental information, they have reconfirmed the following:

1. that the sound power levels of the E82 and E101 turbines do not exceed beyond the values at 95% rated capacity,
2. that the turbines shall not exceed the guaranteed maximum sound power levels for hub heights specified; and
3. that the tonal audibility shall be equal to or less than 2 dB over the whole operational range, including at wind speeds of 10m/s.

Stantec confirms that the analysis provided in the Noise Assessment Report considered the spectral sound power data (i.e. frequency based data) based on the IEC test and overall sound power level corresponding to 95% rated electrical output power as guaranteed by the manufacturer (Enercon). The manufacturer has confirmed that the sound power level at 95% rated capacity is independent of height and wind speeds and has addressed the tonality concerns in a separate letter attached.

The MOE raised similar concerns during the screening of REA application for completeness and we provided additional discussion and rationale at that time. We understood that this additional information was sufficient to address your concern, but trust that the supplemental information now provided by Enercon further supports the completion of your technical review.

If you require further information in this regard, we request that a meeting be held to review and discuss this issue with our noise experts as soon as possible.

Sincerely,

Chris

**Chris Powell, M.A.**

Project Manager, Environmental Planner  
Stantec  
49 Frederick Street Kitchener ON N2H 6M7  
Phone: (519) 585-7416  
Cell: (519) 501-2368  
Fax: (519) 579-6733  
Chris.Powell@stantec.com

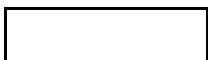

 Please consider the environment before printing this email.

---

**From:** Miller, Denton (ENE) [<mailto:Denton.Miller@ontario.ca>]  
**Sent:** Friday, February 21, 2014 12:39 PM  
**To:** Powell, Chris; Raetsen, Sarah (ENE); Hung, Timothy  
**Cc:** Ganesh, Kana; Leggett, Al; 'darrenc@nrwc.ca'; 'sberriman@nrwc.ca'; 'mervcroghan@nrwc.ca'  
**Subject:** RE: Niagara Region Wind Farm Info Request -2c MOE ref file # 1175-972NB9

Hello Chris

I have yet to receive a response to the e-mails I sent to your office on January 24, and 30 , 2014 regarding the sound power levels of the proposed turbines (questions 2 & 3 in the January 24, 2014 email to your office; copied below).

Please provide a response by **March 7, 2014**. If your firm is unable to provide a response by this date I will have to stop the clock on our service guarantee time.

If you have any questions , please feel free to contact me.

PS:  
I also have additional questions via EBR comments pertinent to vacant lots which I will send to you in a separate e-mail later today.

*Regards*  
*Denton Miller*  
*416-314-8310*

---

**From:** Powell, Chris [<mailto:Chris.Powell@stantec.com>]  
**Sent:** January 30, 2014 8:29 AM  
**To:** Miller, Denton (ENE); Raetsen, Sarah (ENE); Hung, Timothy  
**Cc:** Ganesh, Kana; Leggett, Al; 'darrenc@nrwc.ca'; 'sberriman@nrwc.ca'; 'mervcroghan@nrwc.ca'  
**Subject:** Re: Niagara Region Wind Farm Information request -2 MOE ref file # 1175-972NB9

Ok. I'll follow up with Kana and we will get back to you shortly.

Chris  
Chris Powell, M.A.  
Project Manager  
Environmental Planner  
Stantec  
Cell: (519) 501-2368

Sent from my Blackberry

---

**From:** Miller, Denton (ENE) [<mailto:Denton.Miller@ontario.ca>]  
**Sent:** Thursday, January 30, 2014 08:26 AM  
**To:** Powell, Chris; Raetsen, Sarah (ENE) <[Sarah.Raetsen@ontario.ca](mailto:Sarah.Raetsen@ontario.ca)>; Hung, Timothy  
**Cc:** Ganesh, Kana; Leggett, Al; Darren Croghan <[darrenc@nrwc.ca](mailto:darrenc@nrwc.ca)>; Shiloh Berriman ([sberriman@nrwc.ca](mailto:sberriman@nrwc.ca)) <[sberriman@nrwc.ca](mailto:sberriman@nrwc.ca)>; Merv Croghan <[mervcroghan@nrwc.ca](mailto:mervcroghan@nrwc.ca)>

**Subject:** RE: Niagara Region Wind Farm Information request -2 MOE ref file # 1175-972NB9

Hello Chris.

Thank you for your response to my questions noted in your previous e-mail (January 29, 2014 10:40 AM).

The e-mail has answered question # 1 (RE: Participating Receptors), however questions 2 and 3 still require attention.

Below is additional rationale as to why questions # 2 and 3 will require further clarification from your firm:

**Rationale:**

Documents prepared by the International Electrotechnical Commission note that the apparent sound power level is correlated to the acoustic reference wind speed and not to the wind speed at hub height. An increase in hub height will increase the apparent sound power level and might have an unpredictable effect on tonality.

The following examples from Enercon publications note this phenomenon:

Example 1: Sound Power Level for the E-82 with 2300 kW rated power

in relation to wind speed at 10 m height				
hub height $V_s$ in 10 m height	78 m	85 m	98 m	108 m
5 m/s	96,3 dB(A)	96.6 dB(A)	97.2 dB(A)	97.5 dB(A)
6 m/s	100.7 dB(A)	101.0 dB(A)	101.6 dB(A)	101.9 dB(A)
7 m/s	103.3 dB(A)	103.5 dB(A)	103.6 dB(A)	103.6 dB(A)
8 m/s	104.0 dB(A)	104.0 dB(A)	104.0 dB(A)	104.0 dB(A)
9 m/s	104.0 dB(A)	104.0 dB(A)	104.0 dB(A)	104.0 dB(A)
10 m/s	104.0 dB(A)	104.0 dB(A)	104.0 dB(A)	104.0 dB(A)
95% rated power	104.0 dB(A)	104.0 dB(A)	104.0 dB(A)	104.0 dB(A)

Example 2:

## Sound Power Level for the E-33 with 330 kW rated power

In relation to standardized wind speed $v_s$ at 10 m height					
hub height $v_s$ at 10 m height	37 m	44 m	49 m	50 m	
5 m/s	90.9 dB(A)	91.0 dB(A)	91.3 dB(A)	91.3 dB(A)	
6 m/s	95.1 dB(A)	96.0 dB(A)	96.5 dB(A)	96.5 dB(A)	
7 m/s	98.6 dB(A)	98.9 dB(A)	99.0 dB(A)	99.0 dB(A)	
8 m/s	99.7 dB(A)	99.8 dB(A)	99.9 dB(A)	99.9 dB(A)	
9 m/s	100.0 dB(A)	100.0 dB(A)	100.0 dB(A)	100.0 dB(A)	
10 m/s	100.0 dB(A)	100.0 dB(A)	100.0 dB(A)	100.0 dB(A)	
95% rated power	100.0 dB(A)	100.0 dB(A)	100.0 dB(A)	100.0 dB(A)	

Therefore in accordance with Section 6.2.2 of the Noise Guidelines for Wind Farms please provide the sound power levels, frequency spectra in octave bands (63 to 8000 Hz), and tonality at integer wind speeds from 6 to 10 m/s for the subject wind turbines.

I have another question which I send in a separate e-mail later today.

*Regards*  
Denton Miller  
416-314-8310

---

**From:** Powell, Chris [<mailto:Chris.Powell@stantec.com>]  
**Sent:** January 29, 2014 10:40 AM  
**To:** Miller, Denton (ENE); Raetsen, Sarah (ENE); Hung, Timothy  
**Cc:** Ganesh, Kana; Leggett, Al; Darren Croghan; Shiloh Berriman ([sberriman@nrwc.ca](mailto:sberriman@nrwc.ca)); Merv Croghan  
**Subject:** RE: Niagara Region Wind Farm Information request MOE ref file # 1175-972NB9

Denton,

In response to your email from Friday, January 24, 2014, Kana has provided the justification you are seeking to address your specific questions. Based on his input, we offer the following responses:

### Question 1: Participating Receptors

All of the participating receptors will include project infrastructure and adhere to the definition provided in O. Reg. 359/09 and include a project component.

The REA application considered 80 turbines during the project planning and design stages, including the completion of the various technical reports. The 80 turbine layout is compliant with the noise requirements of the regulation. In order to meet the FIT contract requirements of 230 MW, only 77 of these 80 turbines are to be built (each rated at 3 MW - one or more to be de-rated to satisfy the 230MW requirement).

The specific turbines to be constructed will depend on the detailed engineering and wind resourcing studies to be completed. The decision to drop a turbine depends highly on wind power, and it is likely that a turbine may be dropped from a cluster of turbines where more than one turbine is located within the same property (due to wind resources). Based on that understanding, all participating receptors will continue to fit the definition of participating receptors.

In the event that a turbine is dropped from a property with only one turbine, the design of the wind farm will ensure that project infrastructure remains on that property to ensure its compliance as a participating receptor, in the event that it violates the 40.0 dBA noise threshold, as defined in the regulation.

Question 2: Re Table 3.1 ; Sound Power Levels for the E-101

In preparing the noise model and assessment, Stantec concluded the data is valid based on the following:

- a. Stantec used sound power levels in the analysis, which is a parameter independent of height of the source;
- b. The manufacturer has guaranteed /confirmed to NRWC that their machine will meet the sound power requirements as specified in the test sheet (included with the report); and
- c. IEC 61400-11 (i.e. international standard CAN/CSA-C61400-11-07) uses normalized height so that measurements are independent of height and terrain (i.e. location, where it was measured).

As such, the manufacturer's data values used in the noise model for predicting sound power levels at the various receptors are valid for the E-101 turbines.

Question 3: Re Table 3.1 ; Sound Power Levels for the E-82

Similar to the above rationale, the manufacturer's data values used in the noise model for predicting sound power levels at the various receptors are valid for the E-82 turbines.

We trust that this information is of assistance. If you have any further questions, please do not hesitate to give Kana or myself a call.

Sincerely,

Chris

**Chris Powell, M.A.**

Project Manager, Environmental Planner  
Stantec  
49 Frederick Street Kitchener ON N2H 6M7  
Phone: (519) 585-7416  
Cell: (519) 501-2368  
Fax: (519) 579-6733  
Chris.Powell@stantec.com

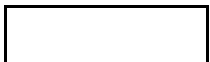

The content of this email is the confidential property of Stantec and should not be copied, modified, retransmitted, or used for any purpose except with Stantec's written authorization. If you are not the intended recipient, please delete all copies and notify us immediately.

 Please consider the environment before printing this email.

---

**From:** Miller, Denton (ENE) [<mailto:Denton.Miller@ontario.ca>]  
**Sent:** Friday, January 24, 2014 3:15 PM  
**To:** Ganesh, Kana; Hung, Timothy; Raetsen, Sarah (ENE)  
**Cc:** Raetsen, Sarah (ENE); Powell, Chris; Leggett, Al  
**Subject:** RE: Niagara Region Wind Farm Information request MOE ref file # 1175-972NB9



Hello Kana

He have started review of the subject application and to date have the following preliminary questions.

**Question 1: Participating Receptors**

**Background:**

Section 1 of the report notes the following:

The facility is comprised of 80 wind turbine. However, only 77 of the wind turbines will be constructed.

Section 4.2 of the report notes the following:

There are a total of 96 Participating Receptors.

**Issue:**

Please confirm that the participating Noise Receptors adhere with the definition in Section 1(6) of O. Reg. 359/09. Specifically will all participating receptors have infrastructure located on them?

If this is not the case then some of these participating receptors must be considered as points of reception and the analysis in the report updated to address these points of reception.

---

**Question 2: Re Table 3.1 ; Sound Power Levels for the E-101**

It is noted that the data in Appendix D (Enercon E-101) is for a turbine with a hub height of **99 m**. The proposal ( Sept 30, 2013 report ) notes the turbine nacelles will be at **124 m** and/or **135 m** height. Please comment on the implication of using the 99 m data in your analysis to represent turbines at **124 m** and/or **135 m** height .

---

**Question 3: Re Table 3.1 ; Sound Power Levels for the E-82**

It is noted that the data in Appendix D (Enercon E-82) is for a turbine with a hub height of **108 m**. The proposal ( Sept 30, 2013 report ) notes the turbine nacelles will be at **135 m** height. Please comment on the implication of using the 108 m data in your analysis to represent turbines at **135 m** height .

Thank you.

*Regards*  
*Denton Miller*

Denton Miller | Senior Review Engineer | Team 5 | Environmental Approvals Branch | Ministry of the Environment  
2 St. Clair Ave W. 12a Floor Toronto, Ontario, M4V 1L5 | Phone: 416-314-8310 | [Denton.Miller@ontario.ca](mailto:Denton.Miller@ontario.ca)

---

**From:** Ganesh, Kana [<mailto:Kana.Ananthganeshan@stantec.com>]

**Sent:** January 7, 2014 4:18 PM

**To:** Miller, Denton (ENE); Hung, Timothy

**Cc:** Raetsen, Sarah (ENE); Powell, Chris; Leggett, Al

**Subject:** RE: Niagara Region Wind Farm Information request MOE ref file # 1175-972NB9

Thanks for the email Denton and happy New Year to you.

Please find attached the Tables; I have some of them in Word format (readily available) and some in Excel format.

Please let me know word format is acceptable for your purpose.

Best regards

**Kana Ganesh, PhD., P.Eng**

Sr. Acoustics Noise and Vibration Engineer

300 - 675 Cochrane Drive West Tower Markham ON L3R 0B8

Phone: 905-415-6332

Fax: 905-474-9889

kana.ganesh@stantec.com



Design with community in mind

[stantec.com](http://stantec.com)

The content of this email is the confidential property of Stantec and should not be copied, modified, retransmitted, or used for any purpose except with Stantec's written authorization. If you are not the intended recipient, please delete all copies and notify us immediately.



Please consider the environment before printing this email.

---

**From:** Miller, Denton (ENE) [<mailto:Denton.Miller@ontario.ca>]

**Sent:** Tuesday, January 07, 2014 3:27 PM

**To:** Ganesh, Kana; Hung, Timothy

**Cc:** Raetsen, Sarah (ENE); Powell, Chris

**Subject:** Niagara Region Wind Farm Information request MOE ref file # 1175-972NB9

Hello Kana / Timothy

I am the review engineer assigned to this file. To facilitate my review , please forward excel copies of the following tables in the noise assessment report.

Tables:

2.1	3.3	3.6	4.1
3.1	3.4	3.7	6.2
3.2	3.5	3.8	6.3

F.5 Appendix E

F.6 Barrier Co-ordinates

your file # 160950269 dated September 30, 2013.

Thank you

## APPLICATION SUMMARY

<b>Status</b>	<b>New Application</b>	<b>Assigned</b>	
<b>IDS Reference #</b>	<b>1175-972NB9</b>	<b>File #</b>	<b>R- 0018 -13</b>
<b>REA #</b>			
<b>Application Type</b>	<b>New Renewable Energy Approval</b>		
<b>Media</b>	<b>Noise</b>		
<b>Facility Type:</b>			
<b>Client Name</b>	<b>Niagara Region Wind Corporation</b>	<b>Client #</b>	<b>2349-972N8X</b>
<b>Client Aliases</b>			
<b>Site Name</b>	<b>Niagara Region Wind Farm</b>	<b>Site #</b>	<b>9527-972NA9</b>

Denton Miller | Senior Review Engineer | Team 5 | Environmental Approvals Branch | Ministry of the Environment  
2 St. Clair Ave W. 12a Floor Toronto, Ontario, M4V 1L5 | Phone: 416-314-8310 | [Denton.Miller@ontario.ca](mailto:Denton.Miller@ontario.ca)

**Appendix G4 – Supplemental MOECC Receptor Verification Comments****Info Request 12: Receptors 986, 1002, 856, 3139, 3142, 2922**

On September 26, 2014, the Ministry of the Environment and Climate Change (MOECC) raised concerns with respect to the location of 6 PORs that had been identified by members of the public. The rationale for the location of these PORs was requested, along with an update to the NAR is adjustments were required.

***O\_986 – Regional Road 65, West Lincoln***Concern:

The following questions were posed by the MOECC:

1. Please confirm the location (UTM Coordinates) of the POR on this lot.
2. Does the current UTM Coordinates represent a POR?
3. Please identify the building immediately south of the current location of this POR. (Approximately 546 m away from T38).
4. If a POR please amend noise report accordingly.

Response:

Upon review of the aerial photography, the location of this POR does not represent the centre of a noise receptor. As such, the location has been adjusted to the centre of the dwelling, located to the southwest of the original POR location. This adjustment has been reflected in the noise model and corresponding updates to the NAR above. The result of this change is a reduction in the separation between the centre of the closest turbine (T38) and this POR from 573 m to 559 m, and a minor increase in the sound level from 39.5 to 39.8 dBA.

The building immediately south of the current location (i.e. to the southeast of the dwelling) is not a noise receptor. This building, as evidenced by the photograph below, is a garage, and is therefore not reflected in the noise model as a POR.

Action:

The noise model, mapping and appropriate tables in the NAR have been amended to reflect the minor shift in the location of this POR. There are no impacts to the Project since this receptor complies with the minimum setback and noise threshold requirements under O. Reg. 359/09.

***O\_1002 – Regional Road 65, West Lincoln***Concern:

The following questions were posed by the MOECC:

1. Please confirm the location (UTM Coordinates) of the POR on this lot.
2. Does the current UTM Coordinates represent centre of the POR?

Response:

Upon review of the aerial photography, the location of this POR does not represent the centre of the noise receptor. As such, the location has been adjusted to the centre of the dwelling, which has been reflected in the noise model and corresponding updates to the NAR above. The result of this change is an increase in the separation between the centre of the closest turbine (T38) and this POR from 551 m to 555 m, and a minor decrease in the sound level from 39.8 dBA to 39.7 dBA.

Action:

The noise model, mapping and appropriate tables in the NAR have been amended to reflect the minor shift in the location of this POR. There are no impacts to the Project since this receptor complies with the minimum setback and noise threshold requirements under O. Reg. 359/09.

***O\_856 – Inman Rd, Haldimand***Concern:

The following questions were posed by the MOECC:

1. Please confirm the location (UTM Coordinates) of the POR on this lot.
2. Does the current UTM Coordinates represent centre of the POR?

Response:

Upon review of the aerial photography, the location of this POR does not represent the centre of the noise receptor. As such, the location has been adjusted to the centre of the dwelling, which has been reflected in the noise model and corresponding updates to the NAR above. The result of this change is an increase in the separation between the centre of the closest turbine (T20) and this POR from 552 m to 556 m, and there is no change in the predicted sound level, which remains at 40.0 dBA.

Action:

The noise model, mapping and appropriate tables in the NAR have been amended to reflect the minor shift in the location of this POR. There are no impacts to the Project since this receptor complies with the minimum setback and noise threshold requirements under O. Reg. 359/09.

***O\_3139 and O\_3142 – Regional Road 65, West Lincoln***Concern:

The following questions were posed by the MOECC:

1. Please confirm the rationale used to determine the location (UTM Coordinates) of the POR on this lot.
2. Should the POR be a vacant lot receptor?

Response:

Both receptors represent vacant lot receptors as there are no dwellings constructed, or approved for construction, on the subject properties. These receptors were mis-labelled in the original noise model but have been corrected above.

Further, both of these PORs are located on land-locked parcels created as a result of the existing Hydro One transmission lines bisecting the farms (i.e. to the north and south of these parcels). These parcels are legally identified as separate properties with no road frontage. However, noise receptors were conservatively identified on these properties in the unlikely event that future road access was provided from the south along the unopened road allowance. The POR's were located near the south of these properties, closest to the unopened road allowance, similar to the development pattern in the area (i.e. located closest to the potential location where access would be considered). Access from the north is not available. Despite the conflict in naming convention, the location of these POR's represents the location where a potential structure would reasonably be constructed in the event that access from the



south was provided. The minimum REA setback of 550m has been accommodated for these receptors and the noise model demonstrates that the sound level does not exceed 40.0 dBA.

Action:

The noise model, mapping and appropriate tables in the NAR have been amended to re-label these noise receptors as V\_3139 and V\_3142 to reflect the fact that they represent vacant lots. There are no impacts to the Project since this receptor complies with the minimum setback and noise threshold requirements under O. Reg. 359/09.

***O\_2922 – Vaughn Rd, West Lincoln***

Concern:

The following questions were posed by the MOECC:

1. Please confirm the location (UTM Coordinates) of the POR on this lot.
2. Does the current UTM Coordinates represent a POR?
3. Please identify the buildings immediately south of the current location of this POR. (Approximately 520 m away from the closest turbine). If a POR please amend noise report accordingly.
4. Please identify the building immediately north of the current location of this POR. If a POR please amend noise report accordingly.

Response:

Upon review of the aerial photography, the location of this POR does not represent the centre of a noise receptor. Instead, it is located on a shed (or similar storage structure) south of the house and closer to the nearest turbine (T78). As such, the location has been adjusted to the centre of the dwelling north of this shed, which has been reflected in the noise model and corresponding updates to the NAR above. The result of this change is an increase in the separation between the centre of the closest turbine (T78) and this POR from 563 m to 582 m, and a minor decrease in the sound level from 39.6 dBA to 39.4 dBA.

The building immediately south of the current location (i.e. to the southeast of the dwelling) is not a noise receptor. This building is a barn and is therefore not reflected in the noise model as a POR.

Action:

The noise model, mapping and appropriate tables in the NAR have been amended to reflect the minor shift in the location of this POR. There are no impacts to the Project since this receptor complies with the minimum setback and noise threshold requirements under O. Reg. 359/09.

**Appendix E:**  
**Correspondence with MOECC**

**Ministry of the Environment  
and Climate Change**

Environmental Approvals  
Branch

135 St. Clair Avenue West  
1<sup>st</sup> Floor  
Toronto ON M4V 1P5  
Tel.: 416 314-8001  
Fax: 416 314-8452

**Ministère de l'Environnement et de  
l'Action en matière de changement  
climatique**

Direction des autorisations  
environnementales

135, avenue St. Clair Ouest  
Rez-de-chaussée  
Toronto ON M4V 1P5  
Tél : 416 314-8001  
Télééc. : 416 314-8452



August 5, 2015

Adam Rosso, P.Eng., M.Sc.  
Director of Development  
Boralex  
c/o FWRN LP  
4672 Bartlett Road South  
Beamsville ON L0R 1B1  
e-mail: [adam.rosso@boralex.com](mailto:adam.rosso@boralex.com)

Dear Mr. Rosso:

The Ministry of the Environment and Climate Change (MOECC) has reviewed the July 24, 2015 letter (received on July 30, 2015) regarding proposed modifications to the Niagara Region Wind Farm (Project). The MOECC issued Renewable Energy Approval (REA) No. 4353-9HMP2R to Niagara Region Wind Corporation on November 6, 2014. The MOECC understands that the company is seeking amendments to the Project as it was described in the REA application and approved by the MOECC. The MOECC also understands that the company has submitted a REA amendment application to the MOECC with respect to an ownership name change from Niagara Region Wind Corporation to FWRN LP. This amendment application is currently under review.

From the July 24, 2015 letter, the MOECC understands that the company is requesting the following changes:

- 1) Relocation of the Smithville transmission line (at the request of the Township of West Lincoln, to avoid the Town of Smithville and areas proposed for future urban expansion);
- 2) Expansion of the footprint for the Interconnect Station on Mountainview Road (to accommodate additional equipment in response to Hydro One Networks Inc.'s connection requirements);
- 3) Addition of permanent alternative access road from T12 to T11 and from T11 to T41 (to enable the Project to potentially avoid delivery of components from Gore A Road);
- 4) Adjustment of the footprint of the North Substation (to avoid archaeological resources that would require a Stage 3 Archaeological Assessment);
- 5) Addition of operational flexibility to install junction boxes within either the municipal right-of-way or on participating properties within previously assessed areas along the proposed collector line routes (to provide greater flexibility during the detailed design process to address municipal comments);
- 6) Changing 11 of the 80 approved wind turbine models to a customized ENERCON E101 wind turbine, which reduces the hub height of the 11 turbines from 135 metres (m) to 124 m. The number of turbines to be installed will remain the same at 77, and all will be located in the exact same locations as approved;



- 7) Removal of Schedule C from the approval, as the sound power level of the transformer selected for the Project is less than that modelled in the Noise Assessment Report as submitted with the REA application. As such, the reduced sound power level negates the need for sound barriers; and
- 8) Adjustments to access road entrances on private land owned by participating landowners, based on detailed design and the need for turning radius at nine entrance locations.

The MOECC has completed a cursory review of the information provided; however additional information and revised reports will be need to be submitted for the MOECC to complete a comprehensive assessment of the proposed changes. This submission should be submitted in the form of a *Draft Modifications Document*. Details of the components of a Modification Document are provided in Section 3.1.1 of Chapter 10 of the *Technical Guide to Renewable Energy Approvals*. Upon receipt of this submission the MOECC will make a determination regarding the category of project change and provide guidance on next steps.

The *Draft Modification Document* should include:

- A summary of the proposed project changes, including the reason for each change.
- An explanation of how the desired change will resolve any issue(s) identified, whether there are any new negative environmental effects that will or are likely to occur as a result of the proposed change, and if required, how those effects are proposed to be mitigated.
- A list of each report and study submitted with the REA application and a description of the amendments/updates to each, including:
  - where reports or studies do not require a material change to the content, explain how the proposed project change does not impact the document;
  - a table that shows the page number, section, original text and revised text, where appropriate;
  - a summary of the discussions with the Ministry of Natural Resources and Forestry (MNRF) and Ministry of Tourism, Culture and Sport (MTCS) with respect to the proposed change(s) and, if required, what additional work was imposed by the respective ministries; and
  - any new letter or addendum to the original letter issued by MNRF and/or MTCS.
- Identification and a summary of new documents that are now required with respect to the proposed project change(s) that were not part of the consultation process.
- A copy of the original site plan and a revised site plan if it has been changed.
- A revised noise assessment report (NAR) which reflects the proposed project changes and includes:
  - a chart which summarizes the difference in the modelled impact at each noise receptor, comparing the revised model output to that in the previously approved NAR;
  - manufacturer's acoustic emission summary for all wind speeds;
  - manufacturer's statement for tonal audibility and measurement uncertainty;
  - manufacturer's emission test report for the de-rated (2.9 MW) ENERCON E101 wind turbine;
  - manufacturer's guarantee letter with new name plate capacity all in accordance with CAN/CSA-IEC-61400-11.

Upon receipt and review of the *Draft Modifications Document* the Director will categorize the proposed project change (as per Chapter 10 of the Ministry's *Technical Guide to Renewable Energy Approvals*) and will outline any additional requirements which may include notifications,

public meetings and potentially an additional Environmental Registry (EBR) posting.

If you have any questions, please feel free to contact Sarah Raetsen at (416) 326-6089.

Sincerely,



Mohsen Keyvani, P.Eng.  
Supervisor – Team 5  
MOECC, Environmental Approvals Branch

- cc. Kathleen Hedley, Director, MOECC, Environmental Approvals Branch  
Mansoor Mahmood, Manager, MOECC, Environmental Approvals Branch  
Rich Vickers, District Manager, MOECC Niagara District Office  
Steve Green, Provincial Officer, MOECC Niagara District Office  
Jim Beal, A/Renewable Energy Coordinator, MNR  
Chris Schiller, Manager, Culture Services Unit, MTCS  
Irena Jurakic, A/Archaeology Review Officer, MTCS  
Chris Powell, Stantec  
Kerrie Skillen, Stantec  
Shiloh Berriman, Enercon



**FWRN LP**  
4672 Bartlett Road South  
Beamsville, ON L0R 1B1

July 24, 2015

Ms. Kathleen Hedley  
Director  
Environmental Approvals Branch  
Ministry of the Environment and Climate Change  
135 St. Clair Avenue West, Floor 4  
Toronto, Ontario  
M4V 1P5

**Attention: Kathleen Hedley, Director, Environmental Approvals Branch**

**Reference: Niagara Region Wind Farm (the Project) – Proposed Modifications  
MOECC reference # 4353-9HMP2R**

Dear Ms. Hedley;

As you know, Niagara Region Wind Corporation (NRWC) is developing the Niagara Region Wind Farm (the Project), a proposed 230 MW wind energy project within the Townships of West Lincoln and Wainfleet and the Town of Lincoln within the Niagara Region and within Haldimand County in Southern Ontario. Renewable Energy Approval (REA) for the Project was received on November 6, 2014. Since receipt of the REA, and completion of the Environmental Review Tribunal, NRWC has identified the need to make minor amendments to the Project as it was described in the REA Application documents and subsequently approved by the Ministry of the Environment and Climate Change (MOECC).

We are writing to seek confirmation from the MOECC that these changes would be assessed as Technical or Project Design Changes under the MOECC's Technical Guide to Renewable Energy Approvals as per the description provided in this letter.

The proposed modifications include relocation of the transmission line, expansion of interconnect station footprint, alternate access road alignments, reorientation of North substation, relocation of junction boxes, revisions to proposed turbine model / tower height, revision of transformer noise characteristics, and adjustments to the location of access road entrances.

An application to acknowledge the change in ownership has been submitted to acknowledge the change in ownership of the Project from "Niagara Region Wind Corporation to "FWRN LP" as FWRN LP purchased the Project (submitted previously under separate cover).

Further detail is outlined below regarding why these modifications meet the factors for a Technical or Project Design Change classification as outlined in Chapter 10 of the Technical Guide to Renewable Energy Approvals.

## **I. Project Design Change:**

### *A. Smithville Transmission Line Relocation*

This modification involves the rerouting of the transmission line, at the request of the Town of West Lincoln, to avoid the Town of Smithville and areas proposed for future urban expansion. In the event that the amendment is not feasible in the required Project timeframe, the transmission line will follow the originally approved alignment.

The construction and installation activities for the transmission line will be completed in the same manner as described in the Construction Plan Report, submitted as part of the REA Application.

The proposed modification qualifies as a Project Design Change for the following reasons:

- Revises the boundary of the original Project Location.
- Minimal increase in the overall impact at the receptors.
- Requires undertaking Stage 2 Archaeological Assessment and NHA on lands not previously assessed.
- Requires reconfirmation of written comments from MTCS and MNRF.

### *B. Revised Footprint of Interconnect Station*

This modification involves the expansion of the footprint for the Interconnect Station on Mountainview Road to accommodate additional equipment in response to Hydro One Networks Inc. (HONI) connection requirements determined during detailed design while avoiding archaeological resources.

The construction and installation activities for the interconnection station will be completed in the same manner as described in the Construction Plan Report, submitted as part of the REA Application. Additional equipment beyond what was described in the Project Description Report will be installed at this location, including a small building, fence and riser structures, however no transformer is required.

The proposed modification qualifies as a Project Design Change for the following reasons:

- Revises the boundary of the REA approved Project Location;
- Stage 2 Archaeological Assessment and NHA previously completed for REA;

- Requires notification to MTCS for change in project footprint, noting avoidance or archaeological sites;
- It will not require any additional NHA field work. Requires notification to MNRF for small increase in footprint and of any additional features in the ZOI; and
- There are not expected to be any changes to the previous recommendations or comments received from the MNRF and MTCS.

*C. Alternate Access Road Between T12, T11 and T41*

This modification involves adding a permanent alternative access road from T12 to T11 and from T11 to T41. The access roads would be located along the collector line route already approved in the REA. The approved access roads to these turbines are not being modified. The modification would enable the Project to potentially avoid delivery of components from Gore A Road, which has been identified by Haldimand County as a potential concern.

The proposed modification qualifies as a Project Design Change for the following reasons:

- Revises boundary of the REA approved Project Location;
- Stage 2 Archaeological Assessment previously completed for REA;
- Requires notification to MTCS for change in project footprint;
- Requires additional NHA field work and an update to the NHA to recognize changes to natural features;
- Requires reconfirmation of written comments from MNRF; and
- There are not expected to be any changes to the previous recommendations or comments received from the MNRF.

**Technical Changes:**

*D. Adjust Footprint of North Substation*

This modification involves the adjustment of the footprint for the North Substation (north of the Welland River) to accommodate reorientation of the substation during detailed design to avoid archaeological resources that would require a Stage 3 Archaeological Assessment. The footprint would be re-oriented into an area previously assessed as part of the construction laydown area. However, the location of the transformer remains consistent with the REA location as defined in the Noise Assessment Report (NAR) and REA Conditions of Approval.

The construction and installation activities for the North substation will be completed in the same manner as described in the Construction Plan Report, submitted as part of the REA Application.

The proposed modification qualifies as a Technical Design Change for the following reasons:

- No increase to the Project Location size;
- No increase in the overall impact at the receptors;

- Modification will not require additional archaeological or cultural heritage assessment. Assessment for the proposed new footprint area of the North substation has already been completed as part of the assessment of a construction lay down area. Therefore, there are not expected to be any changes to the previous recommendations or comments received from the Ministry of Tourism, Culture and Sport (MTCS) for further assessment; and
- Modification will not require any additional Natural Heritage Assessment (NHA). The NHA for the proposed new footprint area of the North substation was already been completed as part of the assessment of a construction lay down area. Therefore, there are not expected to be any changes to the previous recommendations or comments received from the Ministry of Natural Resources and Forestry (MNRF).

#### *E. Relocation of Junction Boxes*

This modification involves adding operational flexibility to install junction boxes within either the Municipal Right-of-Way, as proposed and approved in the REA, or on participating properties within previously assessed areas along the proposed collector line routes. Currently, the Project is approved to install junction boxes within the Right-of-Way. However, through continued consultation with area municipalities, a request to locate these junction boxes (where feasible) was received. This amendment would provide greater flexibility during the detailed design process to addresses Municipal comments while remaining within previously assessed areas.

The construction and installation activities for the junction boxes will be completed in the same manner as described in the Construction Plan Report, submitted as part of the REA Application.

The proposed modification qualifies as a Technical Design Change for the following reasons:

- No increase to the Project Location size;
- No increase in the overall impact at the receptors;
- Junction boxes will be constructed within previously assessed constructible area along proposed collector and fibre optic lines;
- Modification will not require additional archaeological or cultural heritage assessment. Assessment for the proposed relocation of junction boxes has already been completed as part of the assessment of the Project constructible area. Therefore, there are not expected to be any changes to the previous recommendation or comments received from the MTCS for further assessment; and
- Modification will not require any additional NHA. As above, the NHA for the proposed relocation of junction boxes has already been completed. Furthermore, no new potential effects are anticipated as a result of this modification. Therefore, there are not expected to be any changes to the previous recommendations or comments received from the MNRF.

#### F. Alternate Turbine Model

This modification involves changing 11 of the Project's 80 turbines to a customized ENERCON E101 (2.95MW) turbine on 124 m towers from a combination of different ENERCON models. Since the Project's inception and permitting, ENERCON has further reduced the sound characteristics of the E101 turbine through the following:

- limitation of power output to 2.9MW;
- adjusted power curve for the entire range of operational wind speeds; and
- updates to the generator design.

As a result, the Project no longer wishes to install ENERCON E-82 turbines and is proposing to reduce the tower height from 135 m to 124 m, such that all proposed turbines will be at the same height and the proposed layout will consist of only ENERCON E101 turbines – 69 E101 3.0 MW and 11 E101 2.9MW.

The number of turbines to be installed will remain the same at 77. However, the new turbine model would be physically lower than the REA approved turbines, specifically with a hub height of 124 m (rather than the previously approved hub height of 135 m) and rotor diameter of 101 m. While this reduction in tower height addresses a potential concern raised by Environment Canada during the review of the REA, the Project remains committed to completing the supplemental bird mortality monitoring outlined in the REA Conditions.

Specifications of the REA approved turbines and the new turbine model are summarized below in **Table 1.1**.

	<b>REA Approved Turbine Models</b>		<b>New Turbine Model</b>
Manufacturer	ENERCON	ENERCON	ENERCON
Model	E101	E82	E101
Name plate capacity (MW)	3.0 MW	2.3 MW	2.9 MW
Hub height above grade	124 m or 135 m	135 m	124 m
Blade length	48.6m	38.8 m	48.6 m
Rotor diameter	101 m	82 m	101 m
Blade sweep area	8,012 m <sup>2</sup>	5,281 m <sup>2</sup>	8,012 m <sup>2</sup>
Rotational Speed	Variable, 4 – 14.5 rpm	Variable, 6 - 18 rpm	Variable, 4 – 14.1 rpm
Noise Level	104.8 dBA	103.3 dBA	102.9 dBA
Frequency spectrum	50 Hz or 60 Hz	50 Hz or 60 Hz	50 Hz or 60 Hz

The construction and installation activities for the turbines will be completed in the same manner as described in the Construction Plan Report, submitted as part of the REA Application.

The proposed modification qualifies as a Technical Design Change for the following reasons:



- No increase to the Project Location size, whereby a conservative approach for project footprint was included in the various REA documents and in calculating corresponding setbacks (ex. Waterbody Report, Property Line Setback Report, NHA);
- An updated Noise Assessment Report will be prepared to reflect the change in turbine model and tower height, with supporting documentation to be provided by the turbine supplier. It will demonstrate that there is no increase in the modelled noise levels at any of the noise receptors as presented in the NAR because the noise profile of the proposed turbines results in the same or lower sound levels at all receptors;
- Modification will not require additional archaeological or cultural heritage assessment. Assessment for the current 80 turbine sites has been completed, the modification does not involve the relocation of any turbine sites, and the turbines will be constructed within the previously assessed constructible area. Therefore, there are not expected to be any changes to the previous recommendation or comments received from the Ministry of Tourism, Culture and Sport (MTCS) for further assessment.
- Modification will not require any additional NHA. As above, the NHA for the current 77 turbine sites has been completed, the modification does not involve the relocation of any turbine sites, and the turbines will be constructed within the previously assessed constructible area. Furthermore, no new potential effects are anticipated as a result of this modification. Therefore, there are not expected to be any changes to the previous recommendations or comments received from the MNRF.

#### *G. Alternate Transformer*

The sound power level of the transformer selected for the Project is less than that modelled in the NAR as approved in the REA. As such, the reduced sound power level negates the need for sound barriers as identified in the approved NAR and REA Conditions.

The proposed modification qualifies as a Technical Design Change for the following reasons:

- No increase to the Project Location size;
- An updated Noise Assessment Report will be prepared to address the change in transformer noise for the Project, with supporting documentation to be provided by the transformer supplier. It will demonstrate that there is no increase in the modelled noise at the noise receptors near the Project Location because the noise profile of the transformer results in the same or lower sound levels at all receptors.
- Modification will not require additional archaeological or cultural heritage assessment. Therefore, there are not expected to be any changes to the previous recommendation or comments received from the Ministry of Tourism, Culture and Sport (MTCS) for further assessment.
- Modification will not require any additional NHA. Therefore, there are not expected to be any changes to the previous recommendations or comments received from the MNRF.

#### *H. Revised Access Road Entrances*

This modification involves adjustments to access road entrances, on private land owned by participating landowners, based on detailed design (engineering) and need for turning radius (driving surface) at nine entrance locations;

- Entrance 4 to T79 and T80
- Entrance 10 to T58
- Entrance 22 to T76,
- Entrance 27 to T09 and T51,
- Entrance 36 to T10 and T37,
- Entrance 42 to T82,
- Entrance 46 to T84,
- Entrance 49 to T99,
- Entrance 50 to T20.

The construction and installation activities for the access roads will be completed in the same manner as described in the Construction Plan Report, submitted as part of the REA Application.

The proposed modifications qualify as Technical Changes for the following reasons:

- No increase in the overall impact at the receptors
- Stage 2 AA field investigation are required at one of the proposed entrances (Entrance 36) where the relocated entrance is located outside of the area previously assessed in the REA. The location of the new entrance is along an existing driveway currently used by the landowner. An addendum to the approved Stage 2AA will be submitted to the MTCS for confirmation;
- Modification at the remaining entrances will not require additional archaeological or cultural heritage assessment. Assessment for the proposed shift to entrances has already been completed as part of the assessment of the area surrounding the access road entrances. Therefore, there are not expected to be any changes to the previous recommendation or comments received from the Ministry of Tourism, Culture and Sport (MTCS) for further assessment.
- Modification will not require any additional Natural Heritage Assessment (NHA) field work. Entrance 4 (T79 and 80) and 36 (T10 and T37) result in a small increase to the Zone of Investigation (ZOI) that was assessed in the NHA but features may or may not be described as being within the ZOI. MNRF would be notified of any additional features present within the ZOI. Reconfirmation from MNRF is not expected. There are not expected to be any changes to the previous recommendations or comments received from the MNRF.

### Conclusion

The Project team is continually reviewing design features of the Project layout to consider efficiencies, address stakeholder comments, and further reduce potential environmental impacts. In our opinion, the proposed modifications described above are properly classified as Technical or Project Design Changes because they meet the factors set out in Chapter 10 of the Technical Guide to Renewable Energy Approvals.

We request confirmation from the MOECC that, if submitted as described above, the proposed modifications would be classified as indicated above. The modifications will be communicated by: filing a Notice of Proposed Change in the local newspapers; sending the Notice to stakeholders in the project study area; posting the Notice to the Project website; filing a Modification Report to the MOECC, local Municipalities, and Aboriginal Communities; and posting the Modification Report to the Project website.

If you have any questions or require any further information please do not hesitate to contact the undersigned at 416-389-8942 or Chris Powell at 519-780-8172.

Regards,



Adam Rosso P. Eng. M. Sc.  
Director of Development, Boralex

cc: Chris Powell, Stantec Consulting Ltd.  
Kerrie Skillen, Stantec Consulting Ltd.